



AE12200VDR3.5-01

Operation & Maintenance Manual

FULL ROTATION TYPE RUBBER CRAWLER CARRIER **MST-2200VDR**

Serial No. 225002 and up

WARNING

Unsafe use of this machine may cause serious injury or death. Operators and maintenance personnel must read this manual before operating or maintaining this machine. This manual should be kept near the machine for reference and periodically reviewed by all personnel will come into contact with it.

MOROOKA



MOROOKA CO., LTD.



CONTENTS

ITEM	Page
FOREWORD	0- 1
1. Foreword	0- 2
2. Introduction	0- 3
3. Safety information	0- 4
4. Location of serial number	0- 5
SAFETY	1- 1
1. General precautions	1- 2
2. Precautions for operation of regeneration control-type DPF	1- 4
2.1 Precautions for self-replication of DPF	1- 5
2.2 Precautions for manual-replication of DPF	1- 7
3. Precautions during inspection and maintenance	1-10
4. Precautions before starting engine	1-15
5. Precautions when starting engine	1-17
6. Precautions when traveling	1-18
7. Precautions for operation	1-22
8. Precautions for transportation	1-24
9. Position for attaching safety labels	1-25
OPERATION	2- 1
1. General view	2- 2
1.1 General view of machine	2- 2
1.2 General view of operator's compartment	2- 3
1.3 General view of monitor display box	2- 4
1.4 General view of switch box	2- 4
2. Explanation of components	2- 5
2.1 Meters and lamps	2- 5
2.2 Monitor display	2- 7
2.3 Switches	2-18
2.4 Warning devices	2-23
2.5 Safety lock lever	2-24
2.6 Travel lever	2-25
2.7 Swing and dump control lever	2-28
2.8 Dump body safety bar	2-29
2.9 Fuse box in rear box	2-30
2.10 Fuses inside wiring harness at battery	2-31
2.11 Air conditioner	2-32
2.11.1 Location of vents	2-32
2.11.2 Names and functions Of parts on control panel	2-33
2.11.3 Precautions when using air conditioner	2-35
2.11.4 Precautions for handling off-season	2-35
2.12 AM/FM Radio	2-36



ITEM	Page
2.13 Operator's seat	2-39
2.14 Seat belt	2-41
2.15 Window shield	2-42
2.15.1 Front window (upper)	2-42
2.15.2 Front window (lower)	2-43
2.15.3 Hatch	2-43
2.15.4 Sliding window (door)	2-43
2.15.5 Cab door	2-43
2.15.6 Cab door open lever	2-44
2.15.7 Rear escape window	2-44
2.16 Accessories inside cab	2-45
2.17 Chassis center inspection cover	2-46
2.18 Chassis right side inspection cover	2-46
2.19 Battery inspection cover	2-47
2.20 Front grill	2-47
3. Operation	2-48
3.1 Check before starting engine	2-48
3.2 Handling of regeneration control type DPF	2-51
3.3 Operations and checks before starting engine	2-56
3.4 Starting engine	2-57
3.5 Moving machine off	2-60
3.6 Shifting speed range, changing between FORWARD and REVERSE	2-62
3.7 Steering machine	2-64
3.8 Stopping machine	2-68
3.9 Emergency stopping machine	2-69
3.10 Swinging upper revolving structure	2-70
3.11 Parking machine	2-72
3.12 Stopping engine	2-73
3.13 Leaving cab	2-73
3.14 Checks after stopping engine	2-73
3.15 Locking	2-74
3.16 Precautions when traveling	2-74
4. Handling dump body	2-76
4.1 Operating dump body	2-76
4.2 Operating safety bar	2-77
4.3 Precautions during operation	2-78
5. Handling rubber crawler	2-79
5.1 Features of rubber crawler	2-79
5.2 Prohibited operations for rubber crawler	2-79
5.3 Precautions when using rubber crawler	2-80



ITEM	Page
6. Transportation	2-81
6.1 Loading, unloading work	2-81
6.2 Precautions for loading	2-81
6.3 Precautions for transportation	2-81
7. Cold weather operation	2-82
7.1 Precautions for low temperature	2-82
7.2 After completion of work	2-83
7.3 After cold weather	2-83
8. Long-term storage	2-84
8.1 Before storage	2-84
8.2 Precautions during storage	2-84
8.3 Precautions after storage	2-84
9. Handling battery	2-85
9.1 Precautions when handling battery	2-85
9.2 Removal and installation of battery	2-86
9.3 Precautions when charging battery	2-86
9.4 Starting engine with booster cable	2-87
10. Troubleshooting	2-88
10.1 Problems with engine related parts	2-88
10.2 Problems with chassis related parts	2-89
10.3 Problems with electric related parts	2-90
MAINTENANCE	3- 1
1. Basic outline of maintenance	3- 2
2. Precautions for maintenance	3- 4
3. Use of fuel and lubricants according to ambient temperature	3- 6
3.1 Fuel, coolant, and lubricant table	3- 6
4. Tools and tightening torques	3- 8
4.1 Introduction of necessary tools	3- 8
4.2 Torque list for bolts and nuts	3- 9
5. Periodic replacement of critical parts	3-10
5.1 Periodic replacement interval (every 2 years)	3-10
5.2 Periodic inspection	3-10
5.3 Specified periodic replacement parts	3-11
6. Maintenance schedule chart	3-12



ITEM	Page
7. Service procedure	3-14
7.1 Outline of inspection and maintenance procedures	3-14
7.2 Initial 100 hours service	3-14
7.3 Initial 500 hours service	3-14
7.4 When required	3-15
7.5 Check before starting	3-26
7.6 Every 50 hours service	3-31
7.7 Every 100 hours service	3-32
7.8 Every 250 hours service	3-33
7.9 Every 500 hours service	3-35
7.10 Every 1000 hours service	3-48
7.11 Every 1500 hours service	3-49
7.12 Every 2000 hours service	3-50
SPECIFICATIONS	4- 1
1. Dimension drawing	4- 2
2. Specifications table	4- 3



FOREWORD

1. FOREWORD	0- 2
2. INTRODUCTION	0- 3
3. SAFETY INFORMATION	0- 4
4. LOCATION OF SERIAL NUMBER	0- 5



1. FOREWORD

Thank you for purchasing this Morooka Rubber Crawler Carrier.

This manual describes procedures for operation, handling, testing, and maintenance. It will help the operator realize many years of faithful service from the machine.

Please read this manual carefully BEFORE operating the machine. This will enable you to realize the peak performance of the machine.

For details of handling the engine, please see the separate engine operation manual for any item not given in this manual.

⚠ WARNING

- **Improper operation and maintenance of this machine can be hazardous and could result in serious injury or death.**
- **Operators and maintenance personnel should read this manual thoroughly before beginning operation or maintenance. Always keep this manual on the machine and be sure to read and understand it thoroughly before performing operation and maintenance.**
- **Some actions involved in operation and maintenance of the machine can cause a serious accident if they are not done in the manner described in this manual.**
- **Keep this manual handy and have all personnel read it periodically.**
- **If this manual has been lost or has become dirty and cannot be read, request a replacement manual from Morooka or your Morooka distributor.**
- **If you lend this machine to another person, always have that person read the operation manual and make sure that they understand the content of the manual before starting operation. Be particularly careful to ensure that they follow the safety regulations when operating.**
- **Continuing improvements in the design of this machine can lead to changes in detail which may not be reflected in this manual. Consult Morooka or your Morooka distributor for the latest available information of your machine or for questions regarding information in this manual.**
- **The description of safety is given in SAFETY INFORMATION on page 0-4 and in SAFETY from page 1-1.**



2. INTRODUCTION

1. FEATURES OF THE MACHINE

- Low-ground-pressure rubber crawler type that can travel easily on uneven ground, soft ground, or snow.
- Long, wide rubber crawler to provide powerful and stable drawbar pull.
- Hydraulic drive (HST) to allow travel operations to be carried out with the two levers to give forward and reverse with stepless gear shifting, as well as turning and stopping.
- The upper revolving structure rotates 360 deg., eliminating the need for a U-turn that is normally required for travel while maintaining the forward-facing position. This improves work efficiency even in narrow quarters since no U-turn is required.

2. BREAKING IN THE MACHINE

Your Morooka machine has been thoroughly adjusted and tested before shipment.

However, operating the machine under severe conditions at the beginning can adversely affect the performance and shorten the machine life.

Be sure to break in the machine for the initial 100 hours (as indicated by the hourmeter). Proper breaking in will allow the machine to give you many years of service.

During breaking in, pay particular attention to the following points.

- After starting the engine, idle it for 5 minutes to carry out the warming-up operation.
- Avoid operation with heavy loads or at high speeds.
- Avoid sudden starts, sudden acceleration, sudden steering and sudden stops except in cases of emergency.

3. WARRANTY

If any failure that is considered to be the responsibility of Morooka should occur within 6 months of delivery of the new machine or within 600 hours on the hourmeter, whichever comes sooner, repairs will be carried out free of charge in accordance with the warranty.



3. SAFETY INFORMATION

Most accidents are caused by the failure to follow fundamental safety rules for the operation and maintenance of machines.

To avoid accidents, read, understand and follow all precautions and warnings in this manual and on the machine before performing operation and maintenance.

Do not operate or carry out maintenance of this machine unless you are sure that you understand the explanations and procedures completely.

To identify safety messages in this manual and on machine labels, the following signal words are used.

! DANGER

This word is used on safety messages and safety labels where there is a high probability of serious injury or death if the hazard is not avoided. These safety messages or labels usually describe precautions that must be taken to avoid the hazard. Failure to avoid this hazard may also result in serious damage to the machine.

! WARNING

This word is used on safety messages and safety labels where there is a potentially dangerous situation which could result in serious injury or death if the hazard is not avoided. These safety messages or labels usually describe precautions that must be taken to avoid the hazard. Failure to avoid this hazard may also result in serious damage to the machine.

! CAUTION

This word is used on safety messages and safety labels for hazards which could result in minor or moderate injury if the hazard is not avoided. This word might also be word for hazards where the only result could be damage to the machine.

NOTICE

This word is used for precautions that must be taken to avoid actions which could shorten the life of the machine.

Safety precautions are described in SAFETY from page 1-1.

Morooka cannot predict every circumstance that might involve a potential hazard in operation and maintenance.

Therefore the safety messages in this manual and on the machine may not include all possible safety precautions. If any procedures or actions not specifically recommended or allowed in this manual are used, it is your responsibility to be sure that you and others can do such procedures and actions safely and without damaging the machine. If you are unsure about the safety of some procedures, contact your Morooka distributor.



4. LOCATION OF SERIAL NUMBER

On this machine, there is plate with the machine serial number stamped on it stuck to the backward of the tool box at the left side of the chassis in the position in the diagram on the right.

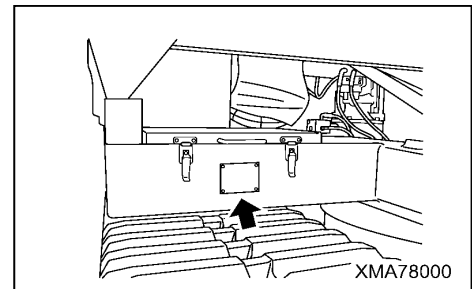

For the position of the engine serial number, please see the separate engine operation manual.

When inquiring about service or ordering parts, please quote the machine serial number, engine serial number, and hour-meter reading.





SAFETY

1. General precautions	1- 2
2. Precautions for operation of regeneration control-type DPF	1- 4
3. Precautions during inspection and maintenance	1-10
4. Precautions before starting engine	1-15
5. Precautions when starting engine	1-17
6. Precautions when traveling	1-18
7. Precautions during operation	1-22
8. Precautions for transportation	1-24
9. Position for attaching safety labels	1-25

WARNING

Read and follow all safety precautions. Failure to do so may result in serious injury or death.

This safety section also contains precautions for optional equipment and attachments.



1. GENERAL PRECAUTIONS

SAFETY RULES	
<ul style="list-style-type: none"> • Only trained and qualified personnel, or personnel authorized by the company (or superior) can operate and maintain the machine. • Follow all safety rules, prohibitions, precautions, procedures, and instructions when operating or performing maintenance on the machine, and pay careful attention to safety. • Operating the machine when you are not in good physical condition reduces the power of judgment needed to avoid danger and leads to accidents. <p>People in the following conditions should not operate the machine.</p> <ul style="list-style-type: none"> • People who cannot operate normally because they are tired, ill, or suffering from the effects of medication. • People who have been drinking. • Pregnant women 	<p>XMA00030</p>

SAFETY FEATURES
<ul style="list-style-type: none"> • Be sure that all guards and covers are in their proper position. Have guards and covers repaired if damaged. • Use safety features such as safety lock levers and seat belts properly. • Improper use of safety features could result in serious bodily injury or death. ★ Emergency stop switch : See "OPERATION 2.3 SWITCHES". ★ Parking brake switch : See "OPERATION 3.11 PARKING MACHINE". ★ Swing lock switch : See "OPERATION 2.3 SWITCHES". ★ Safety lock lever : See "OPERATION 2.5 SAFETY LOCK LEVER". ★ Seat belt : See "OPERATION 2.14 SEAT BELT".

WEAR SUITABLE CLOTHING	
<ul style="list-style-type: none"> • Always wear properly fitting clothes which allow ease of movement. If there are buttons, always button the cuffs. • Avoid loose clothing, towels, jewelry, and loose long hair. They can catch on controls or in moving parts and cause serious injury or death. • Also, do not wear oily clothes, they can easily catch fire. • Wear a hard hat, safety glasses, non-slip safety shoes, and gloves when operating or maintaining the machine. 	<p>A0055010</p>

FIRE EXTINGUISHER AND FIRST AID KIT	
<ul style="list-style-type: none"> • Be sure that fire extinguishers have been provided and read the labels to ensure that you know how to use them. • Provide a first aid kit at the storage point. • Know what to do in the event of a fire. • Be sure that you know the phone numbers of persons you should contact in case of an emergency. 	<p>A0055070</p>

UNAUTHORIZED MODIFICATION
<ul style="list-style-type: none"> • Any modification made without authorization from Morooka can adversely affect the performance of the machine, and may also create hazards. • Before making a modification, consult your Morooka distributor. Morooka will not be responsible for any injury or damage caused by any unauthorized modification.



FIRE PREVENTION FOR FUEL, OIL, AND ANTIFREEZE

Fuel, oil, and antifreeze can be ignited by a flame. Fuel is particularly flammable and can be hazardous.

- Use well-ventilated areas for adding or storing oil and fuel.
- Keep oil and fuel in the determined place and do not allow unauthorized persons to enter.
- Tighten all fuel and oil caps securely.
- Keep any flame away from flammable fluids.
- Do not leave any cloths or rags soaked in oil or fuel lying in the fuel or oil storage area. Clean such materials up immediately.
- Stop the engine and do not bring lighted cigarettes or cigarette lighters close when refueling.

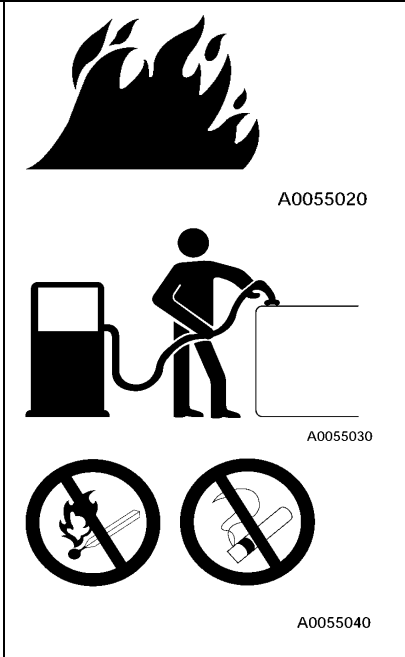

USE HANDRAILS AND STEPS FOR GET ON OR OFF

Get on or off the machine as follows.

- Never jump on or off the machine. Never get on or off a moving machine.
- When getting on or off the machine, always face the machine and use the handrails and steps.
- To ensure safety, always maintain three-point contact with the handrails and steps to ensure that you support yourself.
- If there is any oil, grease, or mud on the handrails or steps, wipe it off immediately. Always keep these parts clean.

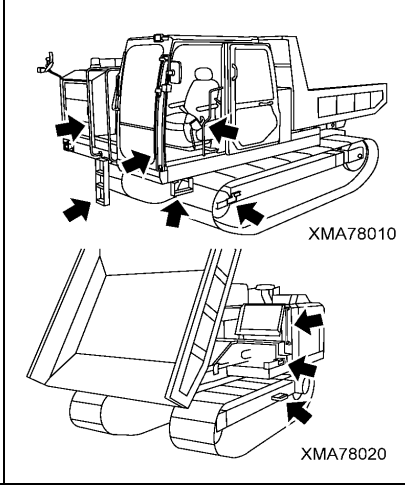

2. PRECAUTIONS FOR OPERATION OF REGENERATION CONTROL TYPE DPF

★Muffler (10) with built-in DPF is formed of a large cylinder and installed on the top of the engine with a special band.

★Regeneration control type DPF (abbreviation for Diesel Particulate Filter) system traps soot (particulate) in emissions with ceramic filters built in the muffler. When the soot deposition exceeds the specified level, automatic regeneration (soot removal by burning) is executed during traveling or operation.

This is called "DPF regeneration".

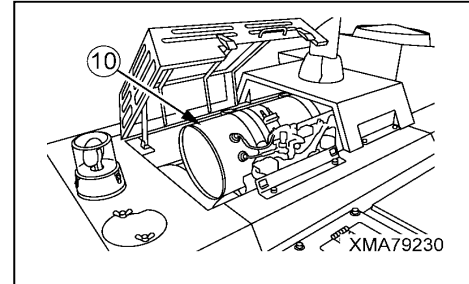

DPF REGENERATION IS DIVIDED INTO TWO TYPES: "AUTOMATIC REGENERATION" AND "MANUAL REGENERATION".

DPF regeneration is divided into "Automatic regeneration" and "Manual regeneration".

Normally "Automatic regeneration" is executed, so "Manual regeneration" is not needed.

Execute "Manual regeneration" if "Automatic regeneration" fails or you want to perform DPF regeneration at a different time or a place.

"Automatic regeneration" is started when DPF soot deposition meter (1) on the monitor display reads near "30%". When "Automatic regeneration" starts, automatic regeneration lamp (↔) (5) on the monitor display lights up to indicate that DPF regeneration is in progress.

Note that the engine controls its speed to the optimum level during DPF regeneration. So, the speed setting with the engine speed control dial is ignored.

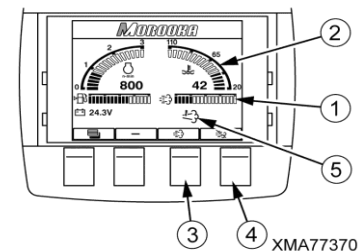

2.1 PRECAUTIONS FOR DPF AUTOMATIC REGENERATION

TAKE CARE NOT TO BURN AND WATCH FOR FIRES DURING DPF AUTOMATIC REGENERATION.

When DPF regeneration starts, the air temperature around the muffler (with built-in DPF) rises extremely high. If you touch such a high-temperature muffler or exhaust pipe, you can get burned or it can cause a fire. Observe the following precautions in preparation for DPF automatic regeneration.

- Before starting work for the day, make sure that flammable items such as dead leaves, dried grass, wood debris, paper, oil, etc. are not attached to the muffler and exhaust pipe, and their surrounding area. Be sure to remove them if attached.
- After DPF automatic regeneration starts, observe the following precautions.
 - Move and park the machine in a safe, flat, and large open space where there are no flammable wood and living trees around the machine.
 - Avoid buildings with poor ventilation. Such a building can cause carbon monoxide poisoning.
 - Make sure that no flammable items are around the muffler and exhaust pipe. Remove them if they are there.
 - Take measures to prevent people from accessing the machine.
 - Stop DPF regeneration if anyone other than authorized personnel enters the space during DPF regeneration.
 - If you are compelled to leave the machine during DPF regeneration, be sure to stop DPF regeneration at once and stop the engine.
- After finishing work for the day, make sure that flammable items such as dead leaves, dried grass, wood debris, paper, oil, etc. are not attached on the muffler and exhaust pipe, and their surrounding area. Be sure to remove them if attached.



A0055020

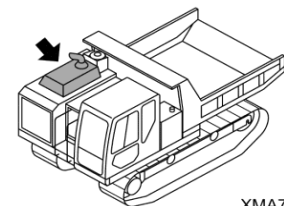

XMA78310

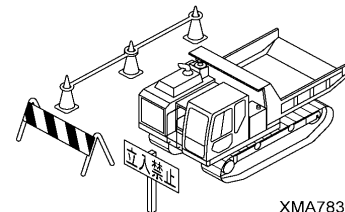

XMA78320

WHILE DEP AUTOMATIC REGENERATION IS IN PROGRESS, AVOID INTERRUPTING OR STOPPING DPF REGENERATION AS MUCH AS POSSIBLE.

- The engine automatically executes DPF automatic regeneration when the DPF soot deposition meter (1) on the monitor display reads near "30%" and DPF regeneration lamp (5) lights up to indicate that DPF regeneration is in progress.
- DPF regeneration lamp (5) keeps lighting up during DPF automatic regeneration. When DPF regeneration completes, DPF regeneration lamp (5) goes out.
- If the engine does not start DPF regeneration with the DPF regeneration lamp (5) lighting up, the engine has an abnormality.
In this case, contact your distributor.
- While you can manually interrupt DPF regeneration under way, once you start DPF regeneration, it is recommended to continue DPF regeneration until the DPF soot deposition meter (1) reads "0%".
- While the machine can be used for normal works during DPF regeneration, do not operate the machine for the work but park it as far away. Repeated start and stop or continuous low-speed traveling of the machine can prevent completion of automatic regeneration. In this case, DPF manual regeneration lamp (7) lights up to alert that manual regeneration is needed.
- To interrupt DPF regeneration urgently, perform the following operations.
 - Continue pressing DPF regeneration stop switch (4) for "3 seconds". The engine stops DPF regeneration.
 - DPF regeneration lamp (5) goes out and DPF regeneration stop lamp (7) lights up.
- To restart DPF regeneration, take the following operations.
 - Continue pressing DPF manual regeneration switch (3) for "3 seconds". The engine restarts DPF regeneration.
 - DPF regeneration stop lamp (7) goes out and DPF regeneration lamp (5) lights up.
- To stop DPF regeneration, set the starting switch to "OFF" position to stop the engine.

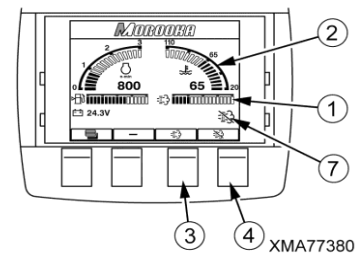
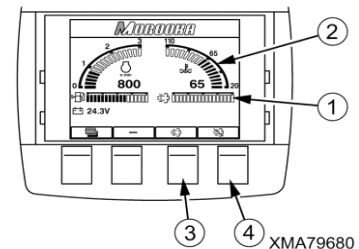
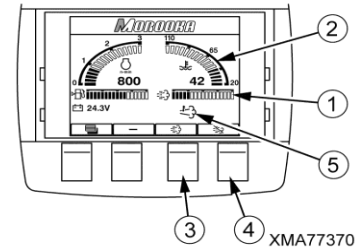

2. 2 PRECAUTIONS FOR MANUAL DPF REGENERATION

CHECK WHETHER A WARNING THAT PROMPTS YOU TO EXECUTE DPF MANUAL REGENERATION IS ISSUED.

While DPF automatic regeneration is in progress, if the machine repeats start and stop or continues low-speed traveling, DPF automatic regeneration may not complete successfully.

Repeated interruption and stoppage of DPF automatic regeneration also increases DPF soot deposition.

In these instances, a warning that prompts you to execute manual DPF regeneration is issued as below.

- When DPF soot deposition meter (1) on the monitor display reads "80%" or more, DPF manual regeneration lamp (6) lights up to issue a warning. If DPF manual regeneration lamp (6) lights up, promptly execute DPF manual regeneration.

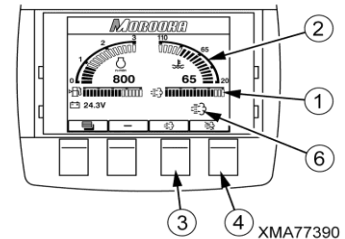

IGNORING THE WARNING THAT PROMPTS YOU TO EXECUTE DPF MANUAL REGENERATION CAN CAUSE ENGINE FAILURE.

When DPF manual regeneration lamp (6) on the monitor display lights up, if the machine is used continuously without executing DPF manual regeneration, the DPF soot deposition increases further and the following phenomena occur.

- DPF soot deposition meter (1) reads above "100%" and engine power drops.
- DPF manual regeneration lamp (6) lights up and engine warning lamp (8) flashes to issue a warning.

When the DPF soot deposition indicated on the monitor display increases further,

- DPF manual regeneration lamp (6) lights up.
- Engine warning lamp (8) flashes.
- Engine stop lamp (9) lights up.

Lighting up of engine stop lamp (9) indicates that DPF regeneration becomes impossible, so the engine stops.

In this case, the DPF needs to be replaced.

In this case, contact your distributor.

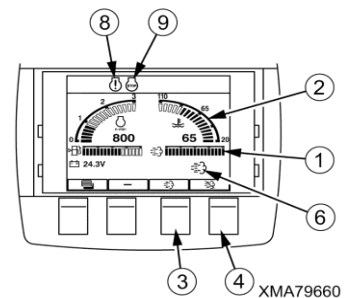

BE CAREFUL NOT TO GET BURNED AND WATCH FOR FIRES DURING DPF MANUAL REGENERATION.

When DPF regeneration starts, the air temperature around the muffler (with built-in DPF) rises extremely high. If you touch such a high-temperature muffler or exhaust pipe, you can get burned or it can cause a fire. Observe the following precautions in preparation for DPF manual regeneration.

- Move and park the machine in a safe, flat, and large open space where there are no flammable wood and living trees around the machine.
- Avoid buildings with poor ventilation. Such a building can cause carbon monoxide poisoning.
- Make sure that no flammable items are around the muffler and exhaust pipe. Remove them if they are there.
- Take measures to prevent people from accessing the machine.
- Stop DPF regeneration if anyone other than authorized personnel enters the space during DPF regeneration.
- If you are compelled to leave the machine during DPF regeneration, be sure to stop DPF regeneration at once and stop the engine.



A0055020

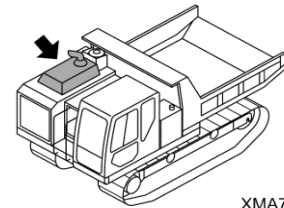

XMA78310

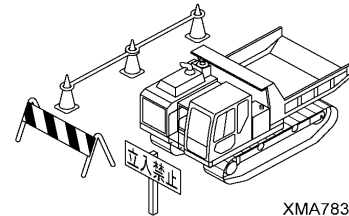

XMA78320



WHILE DPF MANUAL REGENERATION IS IN PROGRESS, AVOID INTERRUPTING OR STOPPING DPF REGENERATION AS MUCH AS POSSIBLE.

When DPF manual regeneration lamp (☸) (6) on the monitor display lights up, execute DPF manual regeneration according to the following procedures.

1. Start the engine and continue warming-up operation until engine water temperature gauge (2) reads "40 °C" or above.

2. Continue pressing DPF manual regeneration switch (3) for "3 seconds". The engine starts DPF regeneration.

★DPF manual regeneration lamp (☸) (6) goes out and DPF regeneration lamp (☸) (5) lights up.

★DPF regeneration lamp (☸) (5) keeps lighting up during DPF regeneration.

3. When DPF regeneration completes, DPF regeneration lamp (☸) (5) goes out and DPF soot deposition meter (1) reads "0%".

★The lower DPF soot deposition is, the shorter the regeneration time (20 to 60 minutes) becomes, so fuel consumption is improved. To improve work efficiency, execute DPF manual regeneration during work break (lunch hour or before/after the start of the work day).

★DPF manual regeneration can be executed when DPF soot deposition meter (1) on the monitor display reads "15%" or above.

Use the same procedures as above to execute DPF regeneration.

★To interrupt or stop DPF manual regeneration, follow the procedures shown below.

• To interrupt DPF regeneration urgently, perform the following operations.

• Continue pressing DPF regeneration stop switch (4) for "3 seconds". The engine stops DPF regeneration.

• DPF regeneration lamp (☸) (5) goes out and DPF regeneration stop lamp (☸) (7) lights up.

• To restart DPF regeneration, perform the following operations.

• Continue pressing DPF manual regeneration switch (3) for "3 seconds". The engine restarts DPF regeneration.

• DPF regeneration stop lamp (☸) (7) goes out and DPF regeneration lamp (☸) (5) lights up.

• To stop DPF regeneration, set the starting switch to "OFF" position to stop the engine.

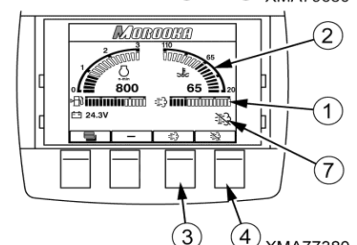
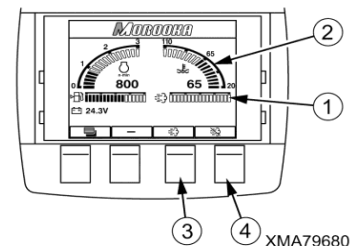
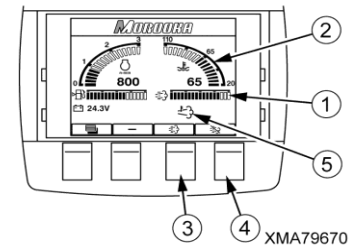
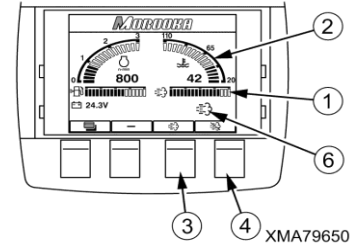



3. PRECAUTIONS DURING INSPECTION AND MAINTENANCE

NO UNAUTHORIZED PERSONS	
<p>Never allow unauthorized persons into the area when carrying out inspection and maintenance.</p> <p>When leaving the operator's seat to carry out operations, hang a "DO NOT OPERATE!" sign (Part No.: 1-41010-1210) on the control lever to prevent any other person from operating the machine.</p>	<p>XMA78030E</p>

USE SUITABLE TOOLS	
<p>Always use tools that are designed for the purpose. Do not use broken or deteriorated tools, or tools that are designed for other purposes.</p>	<p>A0055120</p>

STOP ENGINE WHEN INSPECTION AND MAINTENANCE	
<p>When carrying out inspection and maintenance, always follow the precautions below.</p> <ul style="list-style-type: none"> • Select firm, level ground to park the machine. • Lower the dump body, and apply the parking brake, then stop the engine. • Check that the each control levers are at the Neutral position. • Press the swing lock switch to the ON (LOCK) position. • Place the safety lock lever to the LOCK position. • If the engine must be started to carry out inspection or maintenance, take steps to ensure that the engine can be stopped at any moment. • When carrying out the operation with two or more workers, determine the order of operation and fix signals, and follow the instructions of the person in charge. 	<p>XMA78040E</p> <p>XMA78070E</p>

ALWAYS KEEP MACHINE CLEAN	
<p>Always do the following to keep the machine clean.</p> <ul style="list-style-type: none"> • Always keep the floor, steps, and handrails free of oil, grease, mud, or water. There is danger that you may slip and be injured. Always wipe off any oil, grease, mud or water. • Do not leave tools or parts lying around on the floor or steps. There is danger that you may trip over them. Always clear up tools and parts immediately. • Dry wood chips, leaves, grass, paper, oil, and other flammable materials around the engine, muffler, battery, or hydraulic tank may cause fire. Always remove any flammable objects and wipe off any oil. • Always remove any mud accumulated around the undercarriage. There is danger that you may slip and fall when stepping on to the rubber crawler. 	<p>XMA52650</p> <p>A0055020</p>



VENTILATION FOR ENCLOSED AREAS

Exhaust fumes from the engine can kill.

- If it is necessary to start the engine within an enclosed area, open the doors and windows to provide adequate ventilation.



KEEP AWAY FROM ROTATING AND MOVING PARTS

- Do not go close to the fan when it is rotating. Do not bring anything that can be caught up in the fan close to the fan.
- Do not come close to the dump body when it is moving. There is danger of getting caught or crushed.

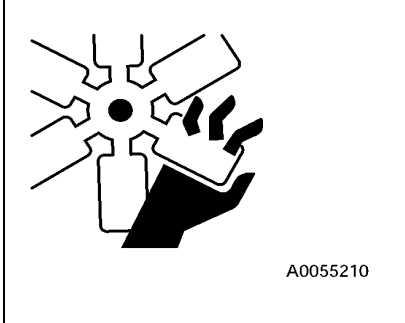

KEEP AWAY FROM FLAME WHEN ADDING FUEL

When filling the fuel tank with fuel, or when draining the water, always follow the precautions below.

- Stop the engine.
- Do not bring any lighted cigarette or cigarette lighter close to the fuel tank.
- After adding fuel, tighten the cap securely and wipe up any spilled fuel.
- Do not bend the fuel hose or hit it with any sharp object.
- If any hose is loose or damaged, always repair or replace it.

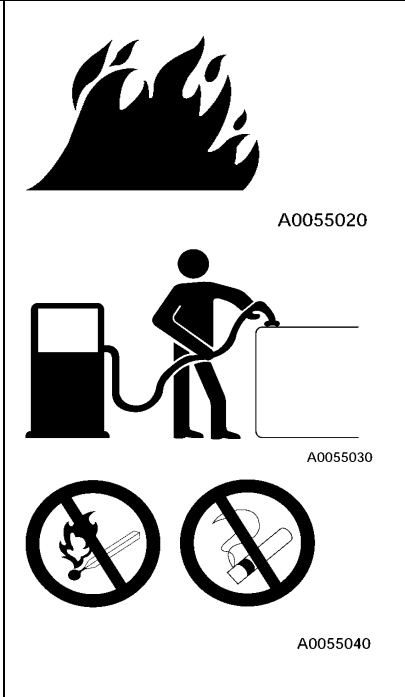



DO NOT TOUCH HIGH-TEMPERATURE, HIGH-PRESSURE PARTS IMMEDIATELY AFTER STOPPING ENGINE

Immediately after stopping the engine, many parts are at high temperature or under high pressure. If parts are removed or touched carelessly, there is danger of burns or other injury. For the following parts particularly, always wait for the machine to cool down before inspecting.

- Radiator and radiator cap
- Hydraulic tank and hydraulic hoses
- Oil cooler.
- Muffler and all parts of engine.

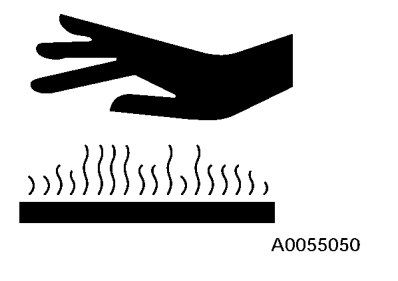

WAIT FOR ENGINE TO COOL BEFORE CHANGING ENGINE OIL

When changing the engine oil, always follow the precautions below.

- Stop the engine and wait for the engine and oil temperature to go down before changing the oil.
- After adding oil, tighten the cap and drain valve securely and wipe up any oil that was spilled.

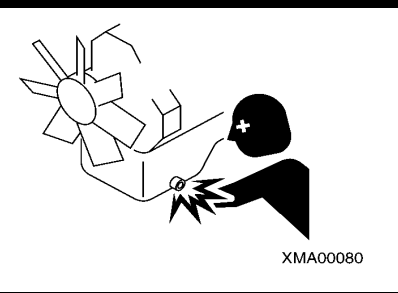

WAIT FOR WATER TEMPERATURE TO GO DOWN BEFORE ADDING COOLANT

Do not add water to the radiator. Always follow the precautions below.

- Stop the engine and wait for the water temperature to go down.
- Turn the radiator cap slowly to release the internal pressure completely, then remove the cap.
- After adding water, tighten the cap securely and wipe up any water that was spilled.

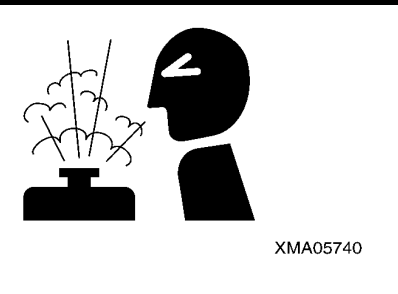

WAIT FOR PRESSURE TO GO DOWN BEFORE ADDING HYDRAULIC OIL

When adding oil to the hydraulic tank or when changing the oil, always follow the precautions below.

- Lower the dump body and stop the engine.
- Loosen the hydraulic tank cap slowly to release the internal pressure completely, then remove the cap.
- After adding oil, tighten the cap and drain plug securely and wipe up any oil that was spilled.

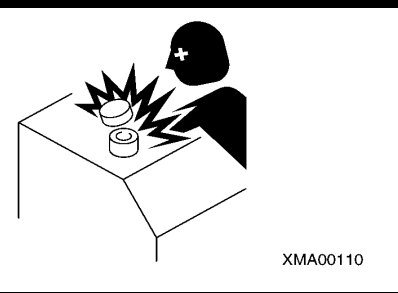



TAKE CARE WHEN HANDLING HIGH PRESSURE HOSES

Remember that oil is always flowing under high pressure in the hydraulic hoses. Do not remove the hoses before the internal pressure has been released.

When handling the high-pressure hoses, always follow the precautions below.

- Do not bend the high-pressure hoses or hit them with any sharp object.
- If any hose is loose or damaged, repair or replace it.
- It is extremely dangerous if oil is leaking from even small holes in the hoses or hydraulic equipment. If such a problem occurs, please contact your Morooka distributor.



A0055180

BE CAREFUL OF HIGH-PRESSURE GREASE WHEN ADJUSTING RUBBER CRAWLER ATTENTION

The rubber crawler tension adjuster is filled with grease. The grease is kept under high pressure by the recoil spring inside the tension adjuster.

Always follow the precautions below when adjusting the tension. If these precautions are not followed, the valve may fly out and cause serious injury.

- Do not loosen the tension adjustment valve more than one turn. There is danger that the valve may fly out.
- When adjusting the tension, do not stand directly in front of the valve; stand to the side to avoid danger.

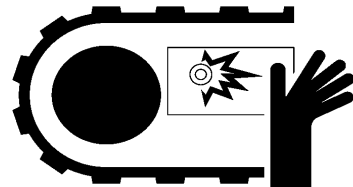

XMA00121

USE SAFETY BAR UNDER DUMP BODY

When going under the dump body to carry out operations, always follow the precautions below.

- Hang a "DO NOT OPERATE !" sign (Part No.: 1-41010-1210) in the operator's compartment to prevent any one else from operating the machine.
- Set the safety lock lever to "LOCK" position so that the dump body does not lower even if someone touches the swing and dump control lever accidentally.
- ★ Safety lock lever : See "OPERATION 2.5 SAFETY LOCK LEVER".
- Always use the safety bar when going under the dump body.
- ★ Safety bar: See "OPERATION 4.2 OPERATING SAFETY BAR".

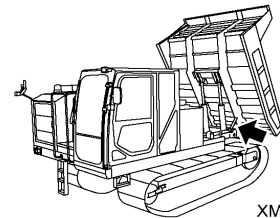

XMA78060

WHEN WORKING UNDER THE UPPER REVOLVING STRUCTURE, BE SURE TO SET THE SAFETY LOCK LEVER TO "LOCK" POSITION.

When working under the upper revolving structure, be sure to observe the following.

- Hang a "DO NOT OPERATE !" sign (Part No.: 1-41010-1210) in the operator's compartment to prevent any one else from operating the machine.
- Press the swing lock switch to the ON (LOCK) position.
- Set the safety lock lever to "LOCK" position so that the upper revolving structure does not swing even if someone touches the swing and dump control lever accidentally.
- ★ Safety lock lever : See "OPERATION 2.5 SAFETY LOCK LEVER".

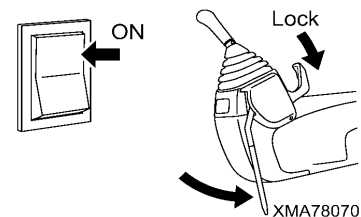

XMA78070E



BE CAREFUL WHEN HANDLING BATTERY

- When checking or repairing the electrical system, always remove the negative (-) terminal from the battery to stop the flow of electricity. Failure to do this may cause fire or short circuit.
- Be careful not to get battery electrolyte on your skin or clothes. If the battery electrolyte gets on you, wash it off immediately with water.

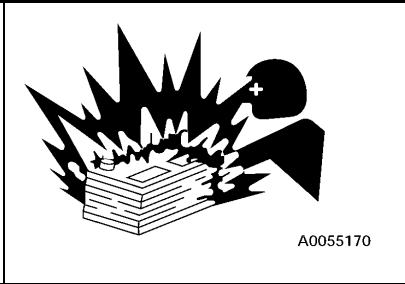

DO NOT SPRAY WATER ON ELECTRICAL COMPONENTS

When washing the machine, do not spray water on the electrical components.
If water gets into the electrical system, it will cause defective operations which may lead to malfunctions.
Cover the following parts with a sheet to prevent water from getting on them.

- Instrument panel and control panel, switches, sensors, connectors
- Starting motor, alternator, sensors, connectors around the engine
- Battery, relay, connectors at front center of machine

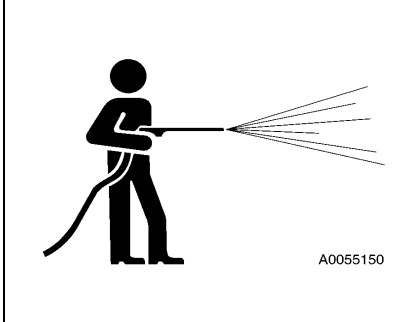

DISPOSE OF WASTE MATERIAL CORRECTLY

- When draining and changing the oil, always put a container under the engine and tank to catch the oil.
- Do not drain the oil directly into the ground or throw it into rivers or the sewage system.
- When disposing of oil, fuel, coolant, solvent, filters, batteries, and other harmful objects, always use a suitable method or procedure.

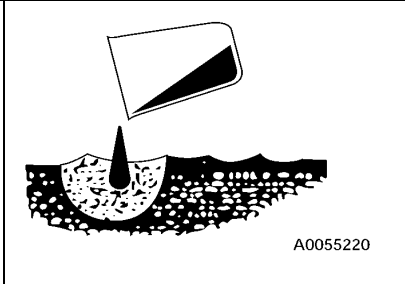



4. PRECAUTIONS BEFORE STARTING ENGINE

ALWAYS CARRY OUT CHECKS BEFORE STARTING

Before starting the engine, always carry out the walk-around checks and inspections given in this manual.

- Check the ground under the machine to see if there is any trace of oil or water leakage.
- Be particularly careful to check the undercarriage for loose or missing nuts and bolts.
- If any abnormalities are found during the check, carry out simple repairs. If the repairs are difficult, please contact your Morooka distributor. The machine must not be used before repairs are carried out.

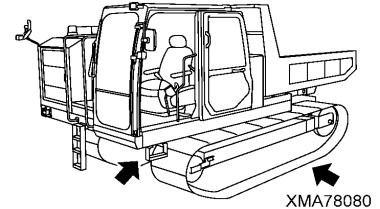

XMA78080

CHECK SAFETY PARTS AND LIGHTING

Check the operation of the following parts and devices needed for operation.

- Check that the horn, buzzer, and turn signal lamps work normally.
- Check that the front lamps light up normally.
- Check that the side mirrors are adjusted so that they give a clear view from the operator's seat.
- Clean the lights to ensure that they give good visibility.
- Adjust the operator's seat to a suitable position for operation. Always adjust the seat if it has been used by another operator.
- Check that the seat belt can be locked properly. Always adjust if it has been used by another operator.

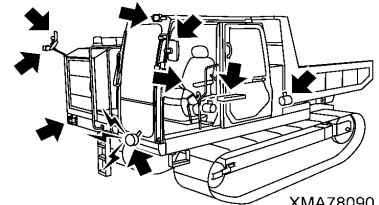

XMA78090

ALWAYS KEEP OPERATOR'S COMPARTMENT CLEAN

Always do the following to keep the operator's compartment clean and tidy.

- Always keep the floor, steps, and handrails free of oil, grease, mud, or water. There is danger that you may slip and be injured. Always wipe off any oil, grease, mud or water.
- Do not leave tools or parts lying around on the floor or steps. Keep these parts in the proper place to prevent them from obstructing operation.

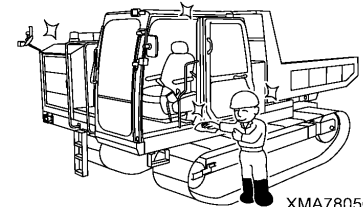

XMA78050

FIRE PREVENTION

- Completely remove all wood chips, leaves, grass, paper and other flammable materials accumulated in the engine compartment. They could cause a fire.
- Check fuel, lubrication, and hydraulic systems for leaks. Have any leaks repaired. Wipe up any excess oil, fuel or other flammable fluids.



A0055020



VENTILATION FOR ENCLOSED AREAS

Exhaust fumes from the engine can kill.

- If it is necessary to start the engine within an enclosed area, open the doors and windows to provide adequate ventilation.



A0055060

SAFETY AT WORKSITE

Before starting operations, thoroughly check the area for any unusual conditions that could be dangerous.

- Check the terrain and condition of the ground at the worksite, and determine the best and safest method of operation.
- If there are any dangerous places, erect signs and take other steps to ensure safety.
- Check the depth and flow of water and the ground condition before operating in water or crossing a river. NEVER be in water which is in excess of the permissible water depth.
- If there are bridges or any other structure, check that they are of sufficient strength to support the weight of the machine.
- Inside the jobsite, do not allow any person other than the signalman to come close. Restrict the entry even of related workers.

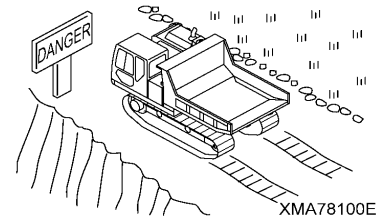

5. PRECAUTIONS WHEN STARTING ENGINE

PLACE LEVERS AT NEUTRAL

Always place the levers at the following positions.

- Place the safety lock lever to the LOCK position.
- Press the swing lock switch to the ON (LOCK) position.
- Place the travel lever at the Neutral position.
- Place the swing & dump control lever at the HOLD position.
- Press the parking brake switch to the ON (STOP) position.
- Sit properly in the operator's seat and fit the seat belt.

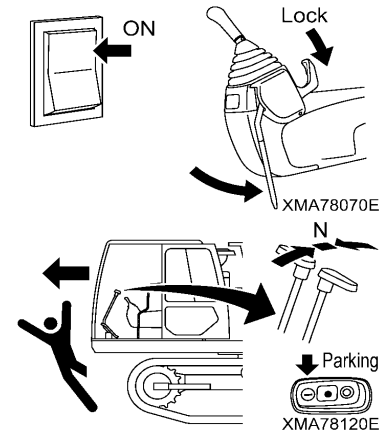

CHECK FOR SAFETY IN SURROUNDING AREA

Always check that there are no people in the surrounding area. Be particularly careful to check under the machine.

- Never start the engine if a warning tag has been attached to the controls.
- When starting the engine, sound the horn to warn people in the area.
- Do not allow anyone other than the operator to ride on the machine.



6. PRECAUTIONS WHEN TRAVELING

IDENTIFY THE FRONT AND REAR OF THE UPPER REVOLVING STRUCTURE.

Before riding on the machine, be sure to check that the upper revolving structure (1) faces in the same direction (forward) as the undercarriage structure (2).

The operating direction of the travel lever and pedal may need to be changed depending on the direction of the upper revolving structure.

- The upper figure on the right shows the machine with upper revolving structure (1) and undercarriage structure (2) facing in the same direction. Since sprocket (A) of undercarriage structure (2) is located forward when viewed from the operator's seat, the operating direction of the travel lever and pedal matches forward/reverse direction and turning directions (left turn and right turn) of the machine.
- The bottom figure on the right shows the machine with upper revolving structure (1) facing in the opposite direction (rear) of undercarriage structure (2). Since sprocket (A) of undercarriage structure (2) is located rearward when viewed from the operator's seat, the operating direction of the travel lever and pedal is opposite to forward/reverse direction and turning directions (left turn and right turn) of the machine.

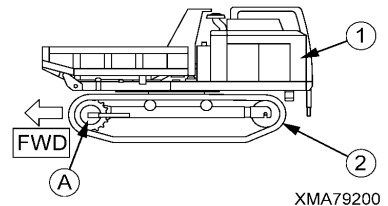
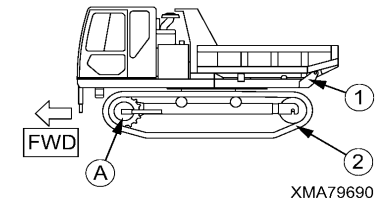

CHECK WHETHER THE REAR SWING PILOT LAMP LIGHTS UP.

When the rear swing pilot lamp lights up, the upper revolving structure is positioned backward. In this case, forward and reverse operations of the lever and pedal are reversed with each other.

After swing operations, be sure to check whether the rear swing pilot lamp lights up.

In addition, be sure to check whether the center pilot lamp lights up.

When the center pilot lamp goes out, the upper revolving structure is not positioned parallel to the undercarriage structure. If they are not positioned parallel to each other, the machine causes a large travel deviation even if you are driving the machine straight ahead.

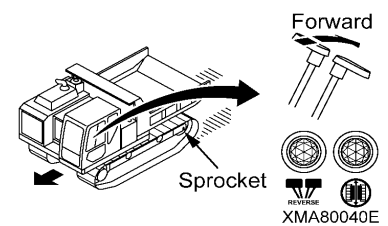

DO NOT USE THE TRAVEL PEDAL FOR TRAVELING OTHER THAN STRAIGHT TRAVEL.

Do not use the travel pedal for traveling other than straight travel.

When using the travel pedal, it is difficult to make fine control of the machine, disabling the machine to make a sure stop and turn a corner. This can cause the machine to hit other obstacles, fall, or run over others.

Do not make travel operations using the travel pedal in the following cases.

- Be sure to use the travel lever.
- Stopping the machine
 - Passing through narrow quarters
 - Traveling uphill or downhill
 - Turning (left turn and right turn)
 - Making a pivot turn

Do not place your foot on the travel pedal except when performing travel operations.

If you are performing other works with your foot placed on the travel pedal, you may depress the travel pedal accidentally allowing the machine to move unexpectedly. This can cause serious injury or death.

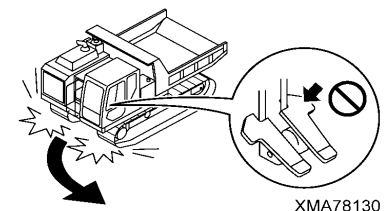



CHECK FOR SAFETY IN SURROUNDING AREA

Always check that there are no people in the surrounding area. Be particularly careful to check behind the machine.

- If the dump body is raised, always lower it.
- Sound the horn to warn people in the area that you are about to start the machine.

AVOID SUDDEN OPERATIONS EXCEPT IN EMERGENCIES

Do not suddenly start, suddenly stop, or suddenly turn the machine or carry out any other operation suddenly. Such operations may cause the crawler to come off and the machine to tip over.

- When starting or turning the machine, operate the travel lever slowly. Run the engine at low speed.
- Return the travel lever slowly to the Neutral position. Apply the brake to stop the machine.
- If the travel lever is moved too far beyond the Neutral position to the REVERSE (or FORWARD) position, the engine will run in reverse, or other problems will occur.
- Do not use the emergence stop switch and the parking brake to stop the machine.
- If a dangerous state occurs by any possibility, and when it becomes necessary to stop the machine urgently, press the emergence stop switch or turn the engine starting switch to the OFF position to stop the engine.

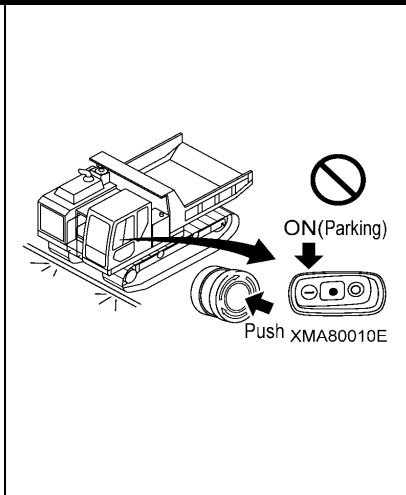

TRAVEL CAREFULLY ON UNEVEN GROUND OR ON CURVES

When traveling on uneven ground or in places where there are many curves, reduce the travel speed and travel carefully. If the machine is traveling at high speed it may turn over or crawler may come off.

NO TRAVELING ON PUBLIC ROADS

This machine is not permitted to travel on public roads. When moving the machine, always transport it by trailer.

BE CAREFUL OF ROAD SHOULDERS

When traveling on narrow agricultural roads, always follow the precautions below.

- Do not travel too close to the road shoulder, and travel at reduced speed.
- Do not travel on any soft road shoulder or place covered with grass.
- During or after rain, the danger of landslides and falling rocks increases. Always travel at low speed and check that the area is safe.

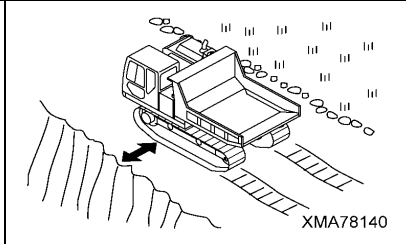



AVOID OBSTACLES

Avoid traveling over obstacles or earth embankments as far as possible. If the machine has to travel over an obstacle, do as follows.

Never travel over large boulders, breakable objects, pieces of concrete, or other sharp objects.

- Reduce the travel speed and travel carefully.
- Steer the machine so that the center of the rubber crawler passes directly over the obstacle. Mount the obstacle slowly, and when the machine goes over the top and starts to tip forward, stop the machine. Then slowly start the machine again. Never change direction when doing this.
- Earth embankments may collapse under the weight or vibration of the machine and cause the machine to slip, so drive the machine slowly and do not change speed or direction.

Be particularly careful when traveling over freshly dug ditches. They may collapse.

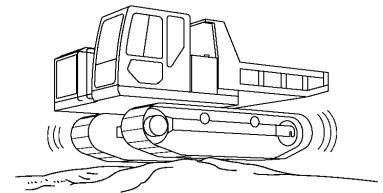

XMA78150

TRAVELING ON SLOPES

When traveling on hills or slopes, always follow the precautions below.

Do not use the travel pedal for traveling other than straight travel.

- When traveling up or down on hills or slopes, select a place where the inclination angle is 9 degrees or below. When the inclination angle exceeds 9 degrees, the slope caution lamp on the monitor display lights up and slope caution buzzer at the rear of the operator's seat sounds.

Even when you must operate the machine in a place with large inclination angle, limit the work site to a place where the inclination angle is 15 degrees or below.

- Do not travel at an angle on a hill or slope, or parallel to the slope. Such action could result in the machine tipping over or slipping.
- When traveling up hills or slopes, always travel directly up the slope. Set the travel speed to a low range and keep the travel lever close to the Neutral position (low speed).
- Do not suddenly change speed on the slope. There is danger that the direction of the machine may suddenly change and the machine may slip.
- When traveling down slopes, set the travel speed to a low range, run the engine at low idling, and operate the travel lever to a position less than 1/2 of the full stroke from the Neutral position.

If the machine travels too fast, there is danger that the engine will overrun and the machine may slip.

- When the slope caution lamp on the monitor display lights up and slope caution buzzer at the rear of the operator's seat sounds, set the engine speed to a low speed, place the travel lever at a position close to "Neutral", and operate the machine carefully.
- Do not travel on grass, fallen leaves, wet steel plates, or other slippery objects.
- If a dangerous state occurs by any possibility, and when it becomes necessary to stop the machine urgently, press the emergency stop switch or turn the engine starting switch to the OFF position to stop the engine.

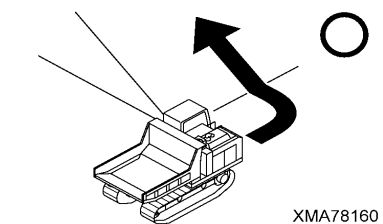

XMA78160

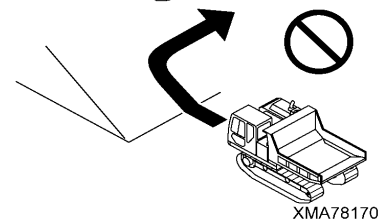

XMA78170

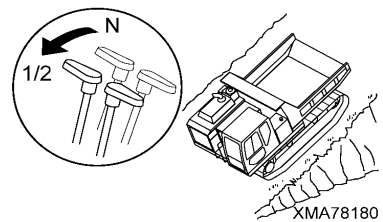

XMA78180

ENSURE GOOD VISIBILITY

When working in dark places or at night, turn on the head lamps.

Turn on the lights in mist, snow, or rain.

OPERATE CAREFULLY ON SNOW

- When working on snow or icy roads, even a slight slope may cause the machine to slip to the side, so always travel at low speed and avoid sudden starting, stopping, or turning.
- When there has been heavy snow, the road shoulder and objects placed beside the road are buried in the snow and cannot be seen, so always carry out operations carefully.

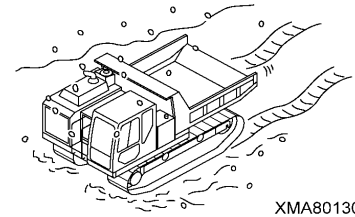

XMA80130

CONFIRM THE SAFETY OF THE SURROUNDING AREA BEFORE SWINGING THE UPPER REVOLVING STRUCTURE.

- Before swinging the upper revolving structure, be sure to stop the machine in a flat place.
When you attempt to swing the upper revolving structure on a slope, the swing speed will increase unexpectedly as the upper revolving structure moves from a high position. This can cause an unexpected accident.
- If there are other persons or obstacles around the machine, enlist a guide who confirms the safety of the surrounding area and perform swing operations according to his/her instructions.
- Be slow in operating the swing and dump control lever. Swinging the loaded upper revolving structure at a high speed or stopping it suddenly can cause machine failures and compromise the safety of the surrounding area as well.

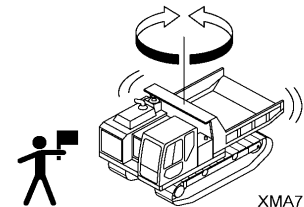

XMA78190

PARKING MACHINE

- Park the machine on firm, level ground.
Select a place where there is no problem of falling rocks, landslides, or floods.
If the machine has to be parked on a slope, do as follows.
- Stop the machine facing directly up or down the slope.
 - Always put blocks under the tracks to prevent the machine from moving.
 - Lower the dump body fully.

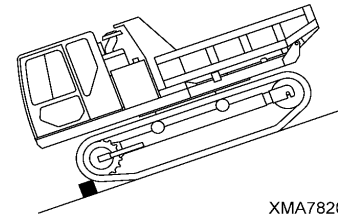

XMA78200

REMOVE KEY WHEN LEAVING MACHINE

- When leaving the machine, always do as follows.
- Lower the dump body fully.
 - Press the swing lock switch to the ON (LOCK) position.
 - Apply the parking brake, and then stop the engine.
 - Place the safety lock lever to the LOCK position and then check the safety lock bar to lowered.
 - Remove the starting key and always take it with you.

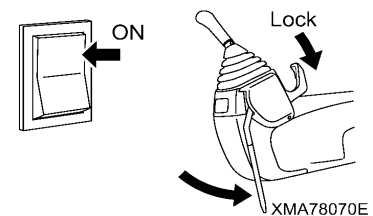

XMA78070E

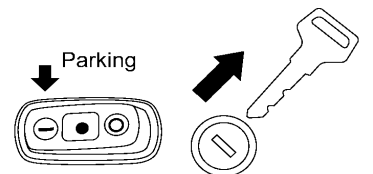

XMA77260E

7. PRECAUTIONS FOR OPERATION

USE SIGNALS

When carrying out work with one or more workers, or when using a signalman, determine the signals and the person in charge before starting work, and always follow the agreed procedure.

Even when using a signalman, always pay careful attention to the following.

- When working in confined spaces or indoors, be careful not to hit the surroundings or the ceiling.
- Be careful about the swing range of the upper revolving structure.
- When operating in urban areas or on roads, put up fences around the jobsite and take steps to ensure the safety of passing traffic and pedestrians.

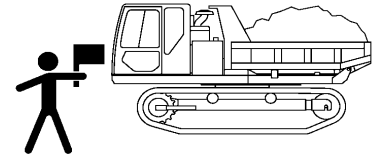

XMA78210

MAKE JOBSITE FLAT

Make the jobsite flat. This will not only increase the efficiency but will also ensure safety. If the jobsite is dusty, spray water to ensure the visibility.

OPERATE DUMP BODY CAREFULLY

When carrying out dumping operations, be careful of the following.

- Check that there is no person or obstacle near the dump body.
- Stop the machine at the determined point and operate the dump in accordance with signals from the signalman.
- Block the tracks to prevent the machine from moving in reverse.
- When dumping on slopes, there is danger of the machine tipping over. If it is felt that there is danger to the machine, stop the operation immediately.

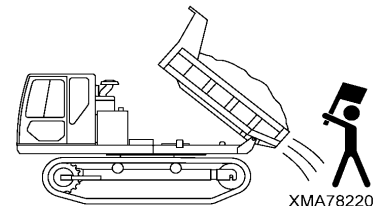

XMA78220

TAKE EXTRA CARE PERFORMING DUMPING OPERATIONS WHEN THE UPPER REVOLVING STRUCTURE IS BEING SWUNG.

When performing dumping operations with the upper revolving structure being swung, in addition to precautions for normal dumping operation, observe the following.

- For the machine that has finished dumping operations with the upper revolving structure being swung in the opposite direction, the traveling directions of the unloaded machine are reversed. Make sure not to mistake the operating direction of the travel lever. Mistaking it can cause a fall or collision.

- When it is necessary to execute unloading operations with the upper revolving structure being swung 90 degrees, check the conditions of the unloading area and keep sufficient distance between the machine and unloading area or the road shoulder in advance.

Be sure to swing the upper revolving structure after the machine has arrived at an unloading area, and lower the dump body after unloading, swing the upper revolving structure to the original position, and then move the machine.

- Executing dumping operations on a slope with the upper revolving structure being swung 90 degrees aggravates the risk of a rollover. Stop the operation if you sense danger in machine stability.

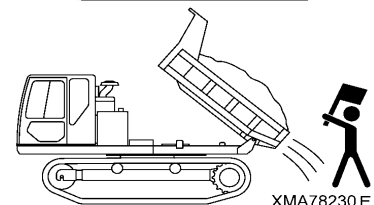
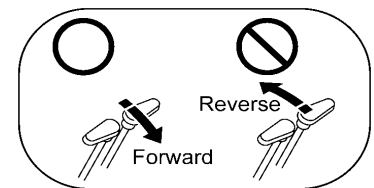

XMA78230 E

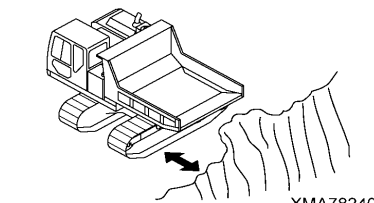

XMA78240



NO OVERLOADING

Never load the machine above its capacity. Overloading will not only cause failures, but will also cause overrunning and tipping over on slopes.

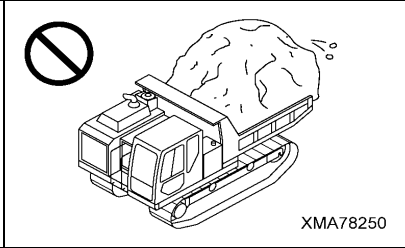

LOAD DUMP BODY EVENLY

- Do not load the dump body on one side. Always spread the load to maintain the balance in the dump body.
- When carrying long objects, such as timber or steel beams, give careful consideration to the position of the center of gravity of the load, and secure with ropes.
- When stacking U-shaped ditch liners or concrete blocks, lay a plate down first and secure with ropes to prevent the load from slipping.

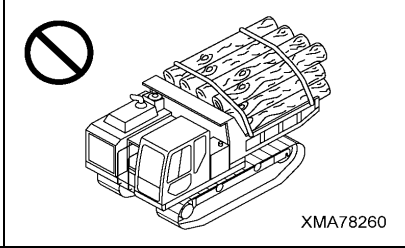

DO NOT GO CLOSE TO HIGH-VOLTAGE CABLE

When carrying out operations on jobsites where there are power cables, use a signalman and take steps to protect the electric cables. Check with the electricity company before starting operations.

- Going close to high-voltage cables can cause electric shock, even if the machine does not touch the cables. Always maintain the safe distance given below between the machine and the electric cable.

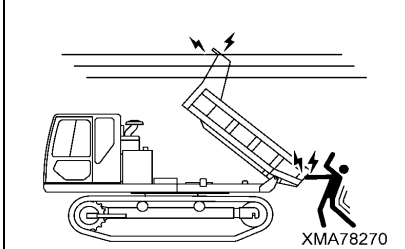

	Voltage of Electrical Cable	Minimum Safe Distance
Low voltage (Distribution line)	100·200V	2m
	6,600V	2m
Special (Transmission line)	22,000V	3m
	66,000V	4m
	154,000V	5m
	187,000V	6m
	275,000V	7m
	500,000V	11m

- If the dump body should touch the electric cable, the operator should not leave the operator's compartment. He should call another worker to report the situation.
The following actions are effective in preventing accidents.
 - (1) Wear shoes with rubber soles.
 - (2) Use a signalman to give warning if the machine approaches too close to the electric cables.
- When carrying out operations near high-voltage cables, do not let anyone come close to the machine.

8. PRECAUTIONS FOR TRANSPORTATION

USE SAFE RAMPS

Always use ramps which fulfill the following conditions.

- Strong ramps which can fully support the weight of the machine.
- Ramps with a width greater than the width of the crawlers.
- Ramps of a length which will not form a steep angle when placed against the platform of the trailer to be used for transportation. If the ramps are too long and they bend excessively, use blocks to support the ramps as necessary.
- Ramps with hooks and non-slip surface.
- Be sure that the ramp surface is clean and free of grease, oil, ice and loose materials. Remove dirt from the machine tracks.

CORRECT

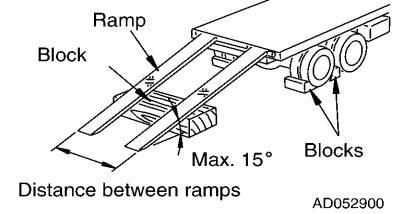

LOADING AND UNLOADING

Loading and unloading the machine always involves potential hazards. **EXTREME CAUTION SHOULD BE USED.**

Always do as follows

- Perform loading and unloading on firm level ground only.
- Stop the engine of the haulage trailer, apply the parking brake securely, and then block the tires.
- Set the ramps parallel and in line with the width of the crawlers.
- Fix the hooks of the ramps securely to the trailer platform.
- Set the machine to be loaded in line with the ramps, and then approach the ramps at low speed.
- Do not correct the direction of travel when on the ramps. If it is necessary to change the direction, drive the machine off the ramps, and set the machine to the correct direction.
- After loading, put blocks under the front and rear of the crawlers to prevent the machine from moving, then tie the machine down with chains or wire rope.

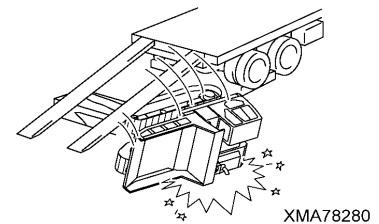

SHIPPING

- When shipping the machine on a hauling vehicle, obey all state and local laws governing the weight, width, and length of a load. Also obey all applicable traffic regulations.
- Take into account the width, height and weight of the load when determining the shipping route.



9. POSITION FOR ATTACHING SAFETY LABELS

Always keep these labels clean.

If they are lost or damaged, always attach them again or replace them with a new label.

There are other labels in addition to the safety labels listed as follows, so handle them in the same way.

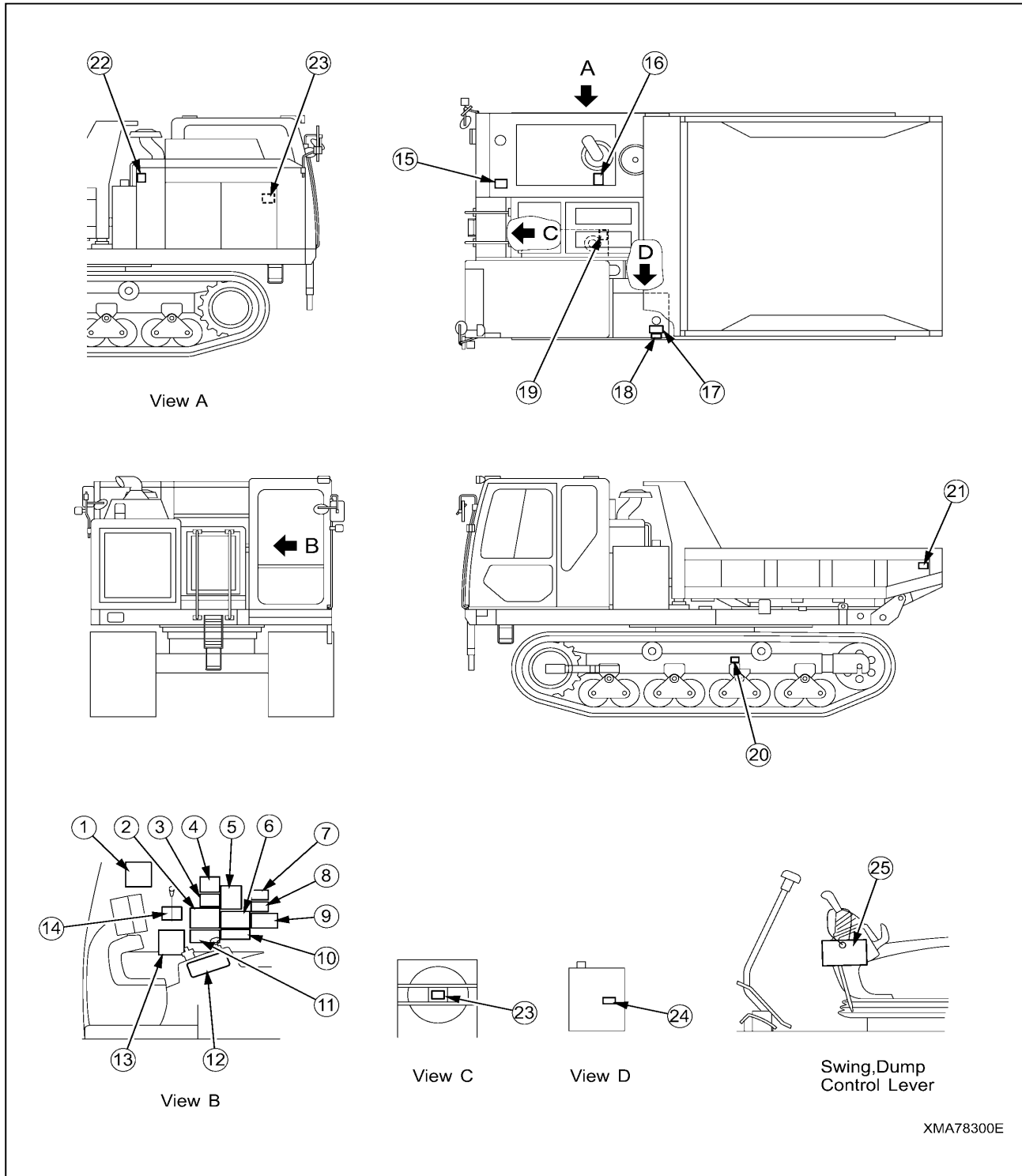



(1) Precautions for safety lock lever
(1-68010-0260)

WARNING

In order to prevent accidents resulting from touching the unlocked operating lever, follow the instructions below before standing up from the driver's seat.

- Completely lower the dump body, set the safety lock lever (on the left of the driver's seat) to the lock position.

Serious injury or death may result if the machine operates abruptly or against the driver's intension.

1-68010-0260

(2) Precautions for operation
(1-68010-0320)

WARNING

- Before operating the machine read the Operation & Maintenance Manual carefully.
- Take extra care when travelling on uneven ground or oval-shaped ground. Depending on the track tension, this may cause the track to disengage or the machine to damage.
- When entering under the dump body for checking, always use the safety bar to prevent the dump body lowering.
- Always dump the load on the level, hard ground.
- When leaving the operators seat, put the travel lever in the neutral position, and put the parking brake switch in the ON position.
- DO NOT use the parking brake as the service brake except in an emergency.
- When leaving the machine, always take the key.

1-68010-0320

(3) Precautions when dump body lowering
(1-68010-0270)

WARNING

Check the safety of the vicinity and release the safety bar under the dump body before lowering the dump operation lever. (Keep in mind that the dump body will be damaged if the safety bar is not released.)

1-68010-0270

(4) Precautions for operation when rotating
(1-68010-0280)

WARNING

1. Check the safety of the front, rear, left, and right sides with utmost attention before turning the super structure.
2. Check the position of the sprocket before operating the travel lever. The reverse running indicator light will be lit and the travel and operating directions of the travel lever will be reversed if the sprocket is on the rear side of the vehicle body. Operate the travel lever with utmost attention.
3. Conduct dumping on the horizontal hard ground.

1-68010-0280

(5) Precautions when travelling downhill
(1-68010-0220)

WARNING

Serious injury may result from tipping over on slopes. Be sure to follow the instructions below.

- Do not load in excess of the maximum load mass.
- Do not drive on slopes in excess of 15 degrees.
 - Do not run.
 - Do not conduct dumping, loading, or swiveling.
- In the case of slopes of 10 degrees or more, press and set the lowest-speed range selector switch to low-speed range and drive straight at half throttle.
- Do not drive in traversal or diagonal directions or zigzag.
- In the case of driving down slopes with a load, lower the engine revolution to drive slower if the slopes become steeper.
- If the speed is too fast, the vehicle may not stop.
- Return the travel lever slowly to come to a stop on slopes.

1-68010-0220

(6) Precaution for starting engine and leaving machine
(1-68010-0330)

WARNING

STARTING ENGINE AND MACHINE

- When starting the engine, put the travel lever in the neutral position, and put parking brake switch in the ON position.
- When traveling the machine, always put the parking brake switch in the OFF position.
- Ensure safety around the machine, sound the horn and start.
- DO NOT operate abruptly: this means no starting abruptly, stopping abruptly or turning abruptly. Operating abruptly may cause the track to disengage or cause the machine to fall over.

1-68010-0330



(7) Precautions for electric shock
(1-68010-0290)

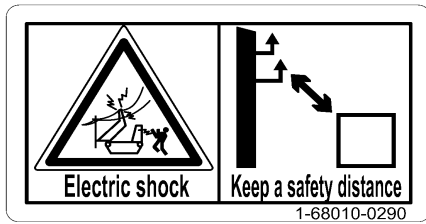

(8) Precautions when transportation
(1-68010-0250)

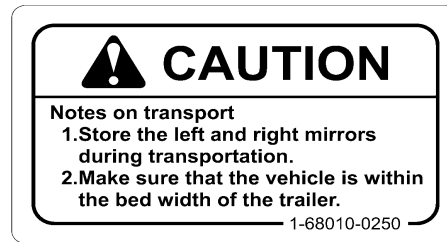

(9) Caution for periodic replacement parts
(1-68010-0340)

CAUTION	
Replace the following parts periodically.	
Periodic replacement parts	Replacement interval
Fuel hose (from fuel tank to fuel injection pump)	Replace every 2 years
Fuel hose (from fuel injection pump to fuel tank)	
Hydraulic pressure hose (from main pump to rotary joint and to left and right travel motor)	
Hydraulic pressure hose (from gear pump to working machine valve)	
Hydraulic pressure hose (from working machine valve to pipe and dump cylinder)	
Hydraulic pressure hose (from working machine valve to turning motor)	
Seat belt	Replace every 3 years

1-68010-0340

(10) Precautions for engine starting operation (2)
(1-46010-3040)

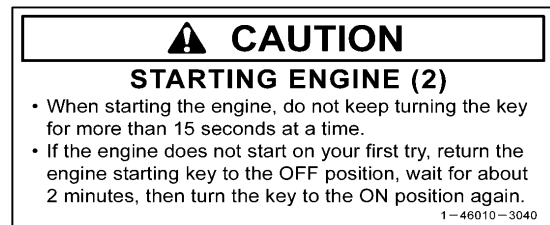

(11) Precautions for engine starting operation (1)
(1-46010-3030)

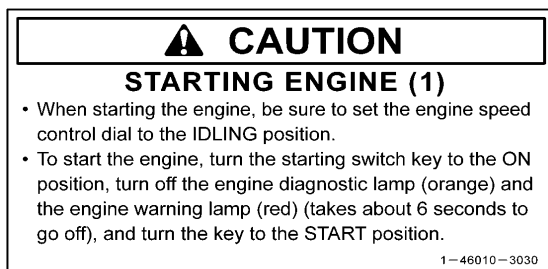

(12) Precautions when engine starting
(1-46010-2460)



(13) Precautions when travelling downhill
(1-68010-0210)



(14) Inclinator
(1-61020-1150)

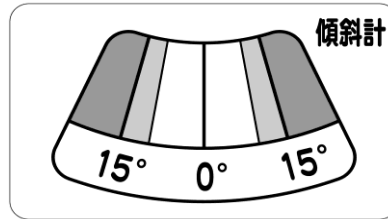

(15) Beware of high-temperature coolant
(1-41010-1300)

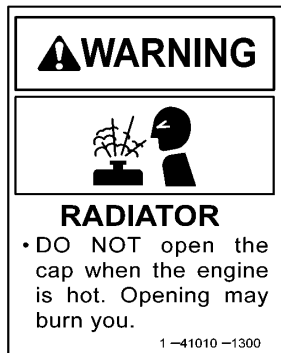

(16) Muffler is at high temperature
(1-41010-1280)



(17) Precautions when adding fuel
(1-41020-1220)



(18) Precautions for diesel fuel
(1-12020-1310)





(19) Precautions for oil inside hydraulic tank
(1-41010-1250)



(20) Precautions for crawler adjustment valve (2 parts)
(1-41010-1270)

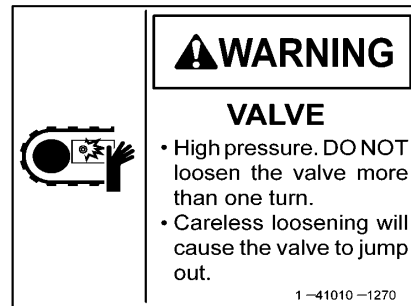

(21) Precautions for keep out rotating area
(1-68010-0230)

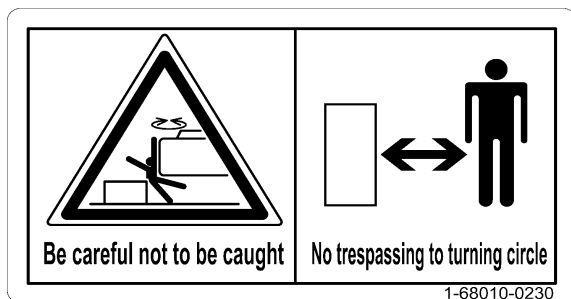

(22) Beware of rotating crawler
(1-41010-1240)



(23) Beware of rotating fan and pulley (2 rotation parts)
(1-41010-1260)

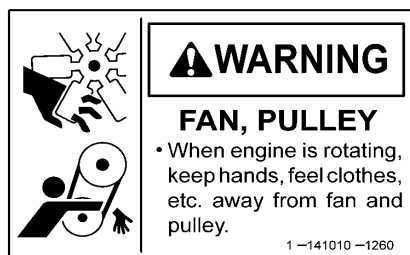

(24) Precautions for explosion of electrical device
(1-68010-0240)



(25) Warning tag to prevent operation during maintenance (Option)
(1-41010-1210)







OPERATION

1. General view	2- 2
2. Explanation of components	2- 5
3. Operation	2-48
4. Handling dump body	2-76
5. Handling rubber crawler	2-79
6. Transportation	2-81
7. Cold weather operation	2-82
8. Long-term storage	2-84
9. Handling battery	2-85
10. Troubleshooting	2-88

1. GENERAL VIEW

1.1 GENERAL VIEW OF MACHINE

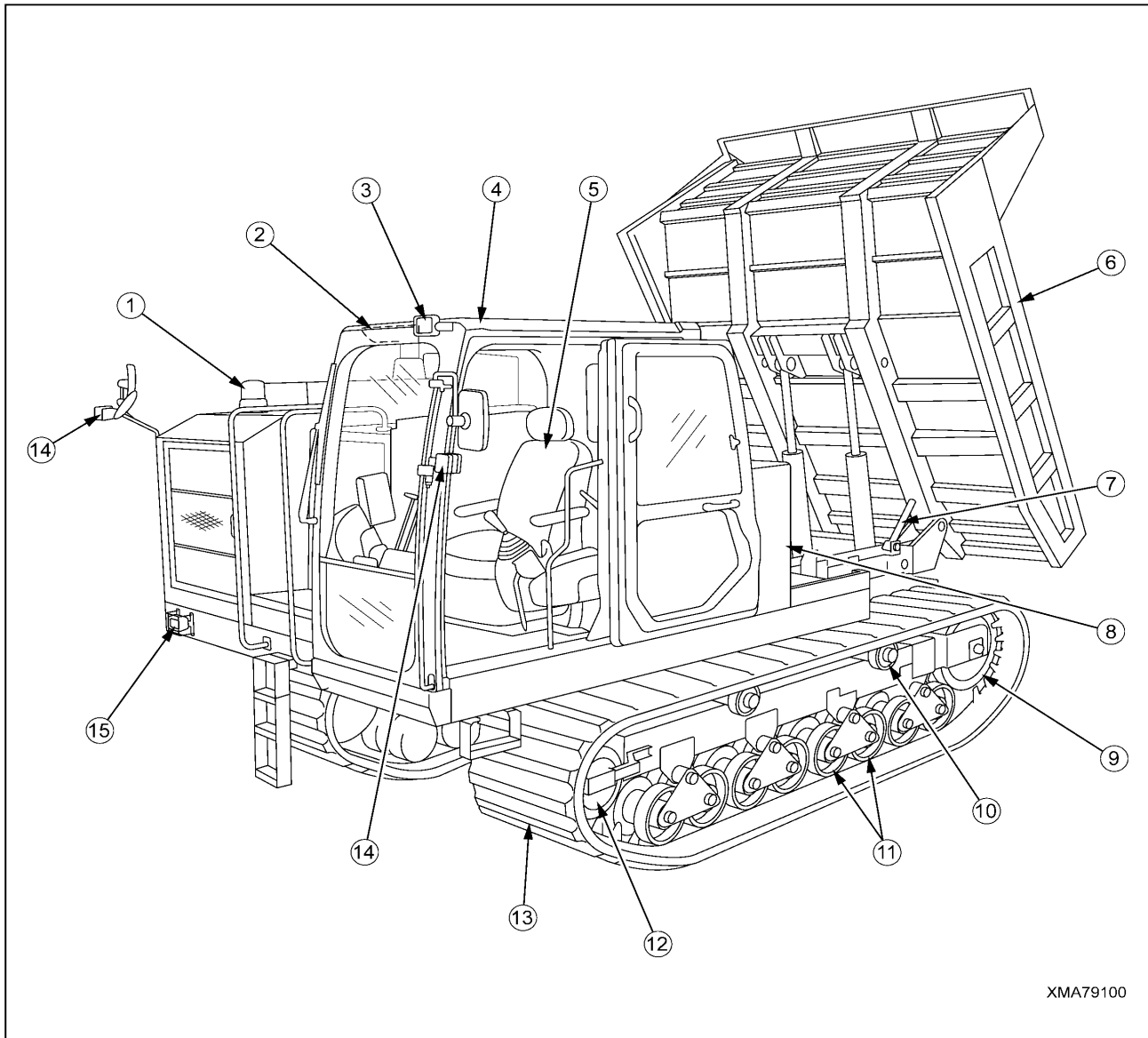

XMA79100

- (1) Rotary lamp (yellow)
- (2) Muffler
- (3) Head lamp
- (4) Cab
- (5) Operator's seat
- (6) Dump body
- (7) Safety bar
- (8) Fuel tank

- (9) Rear idler
- (10) Carrier roller
- (11) Track roller
- (12) Travel motor, sprocket
- (13) Rubber crawler
- (14) Turn signal lamp
- (15) Head lamp

1.2 GENERAL VIEW OF OPERATOR'S COMPARTMENT

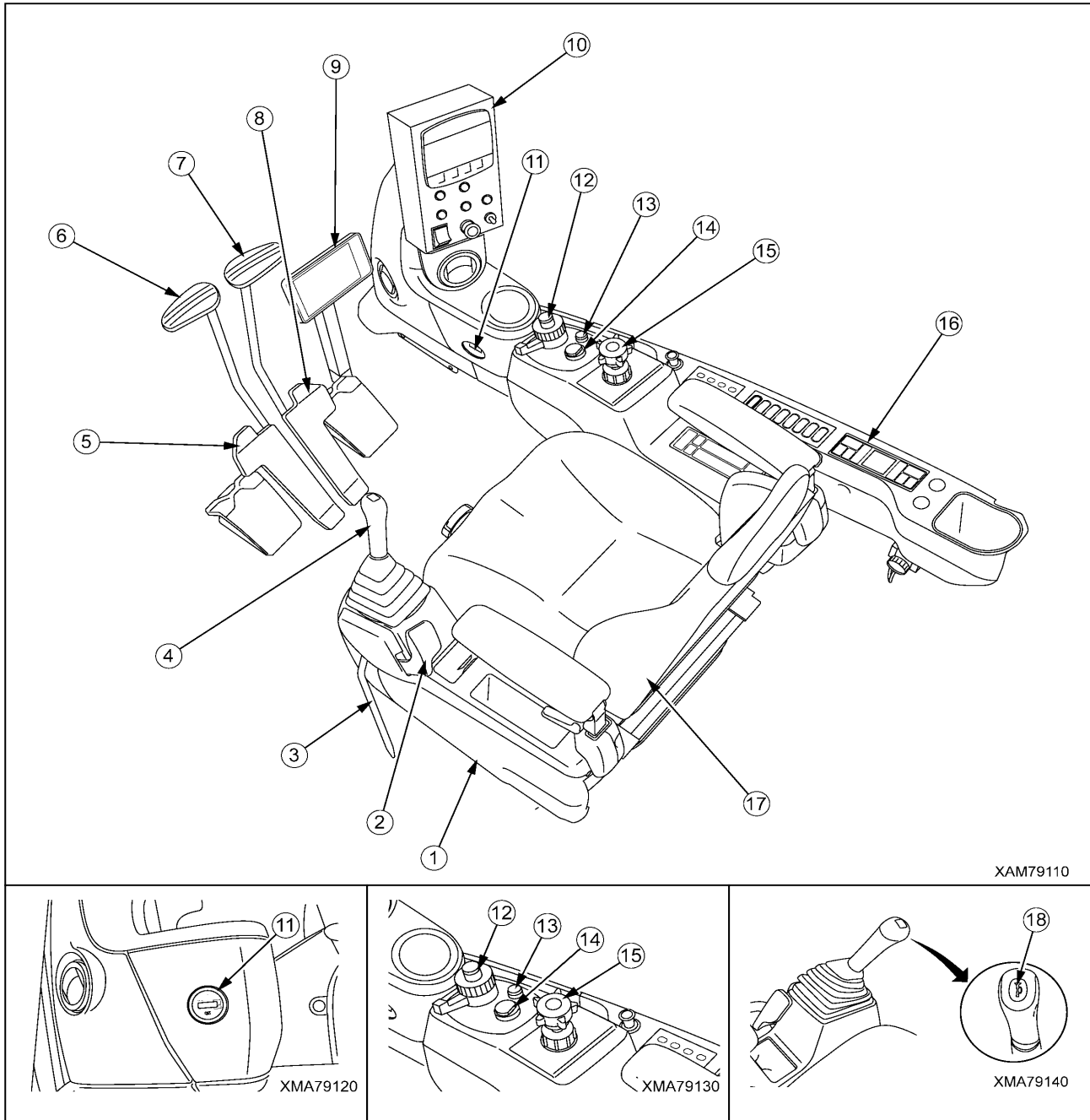

- | | |
|----------------------------------|--|
| (1) Left side console box | (10) Monitor display box |
| (2) Safety lock lever | (11) Hourmeter |
| (3) Safety lock bar | (12) Combination switch |
| (4) Swing and dump control lever | (13) Hi-Lo speed range selector switch |
| (5) Left travel pedal | (14) Starter switch |
| (6) Left travel lever | (15) Engine speed control dial |
| (7) Right travel lever | (16) Seat switch box |
| (8) Right travel pedal | (17) Operator's seat |
| (9) Rear view monitor (Option) | (18) Horn switch |

1.3 GENERAL VIEW OF MONITOR DISPLAY BOX

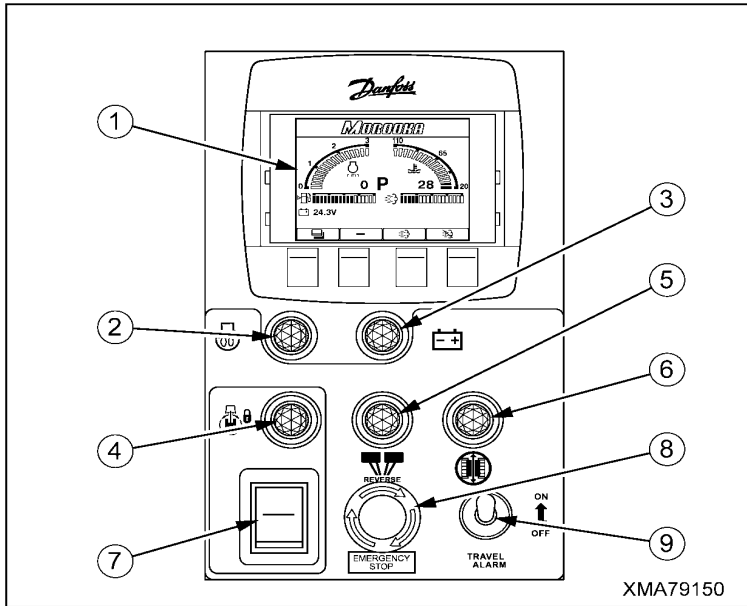

- (1) Monitor display
- (2) Engine glow relay lamp (Orange)
- (3) Battery charge lamp (Red)
- (4) Swing lock pilot lamp (Orange)
- (5) Counter travel pilot lamp (Green)
- (6) Rear area swinging pilot lamp (Red)
- (7) Swing lock switch
- (8) Emergence stop switch
- (9) Travel alarm cancel switch

1.4 GENERAL VIEW OF SWITCH BOX

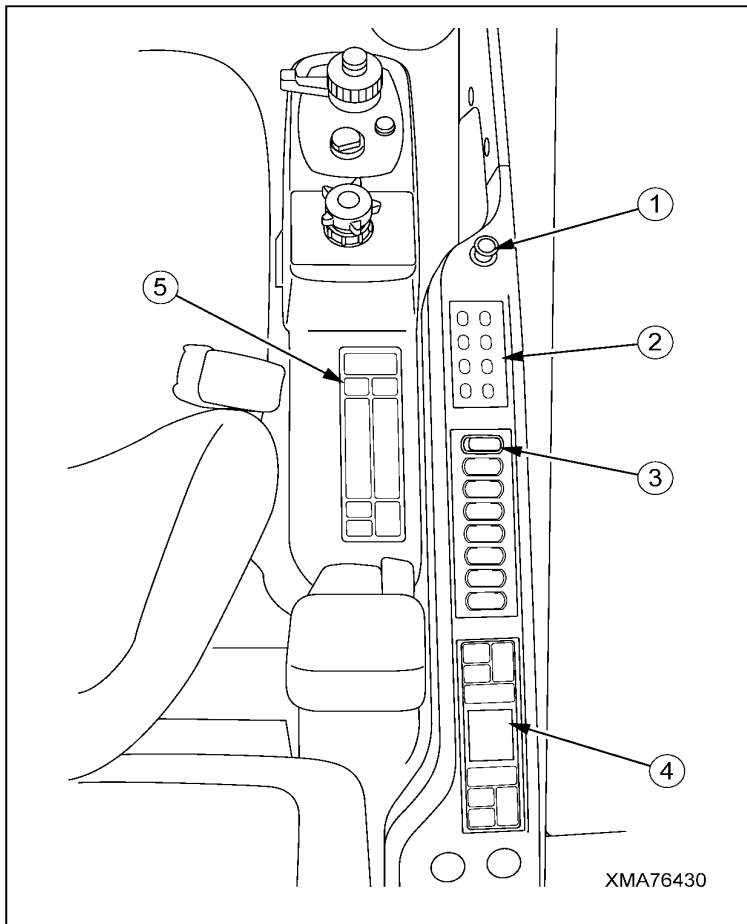

- (1) Cigarette lighter
- (2) Switch panel
- (3) Parking brake switch
- (4) Air conditioner controller
- (5) Car radio



2. EXPLANATION OF COMPONENTS

The following is an explanation of devices needed for operating the machine.

To carry out suitable operations correctly and safely, it is important to understand fully the methods of operating the equipment and the meanings of the displays.

2.1 METERS AND LAMPS

[1] HOURMETER

This shows the total number of hours of the operation of the machine. When the starting switch is at the ON position, the meter will advance even if the machine is not moving.

Use the hourmeter reading as the standard for periodic inspection and maintenance.

★The last digit on the right indicates the time in units of 0.1 hours (6 minutes).

★When you stop the engine, always turn the starting switch to the OFF position.

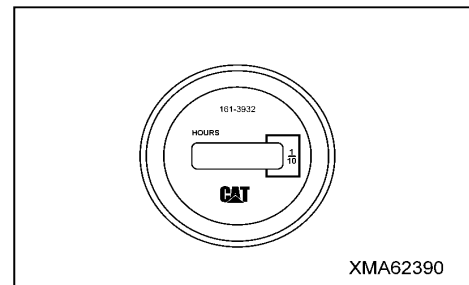

[2] GLOW RELAY LAMP (ORANGE)

This lamp automatically indicates the preheat conditions of the engine. In cold weather conditions, the intake air heater starts to automatically preheat the intake air according to the condition of the intake air temperature and coolant temperature.

If you turn the starting switch to "ON" position and the intake air heater starts preheating, the lamp will light up, and when engine preheating is completed, the lamp will turn off.

★When the glow relay lamp lights up, start the engine after the lamp goes out.

★While the lamp may flash after the engine starts, this does not indicate any problem.

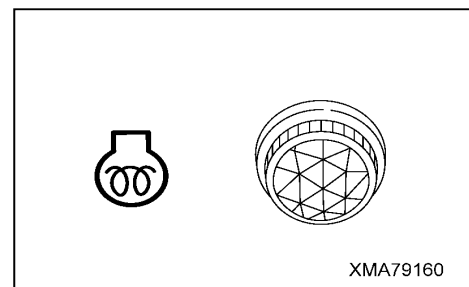

[3] BATTERY CHARGE LAMP (RED)

This shows the condition of the charging system.

It lights up when the starting switch is turned ON, and when the engine is started and the speed rises, it should go out.

If it lights up during operations, there is an abnormality in the charging system.

Stop the engine immediately and check for the problem.

★Check the fan belt damage and fan belt tension.

★If the inspection shows that there is no abnormality, please contact your distributor.

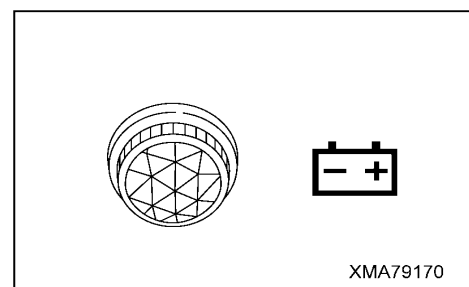

[4] SWING LOCK PILOT LAMP (ORANGE)

This lamp indicates that the upper revolving structure is being locked.

This lamp lights up when the swing lock switch is set to "ON" (LOCK) position, disabling swing operations.

This lamp goes out when the swing lock switch is set to "OFF" (FREE) position, enabling swing operations.

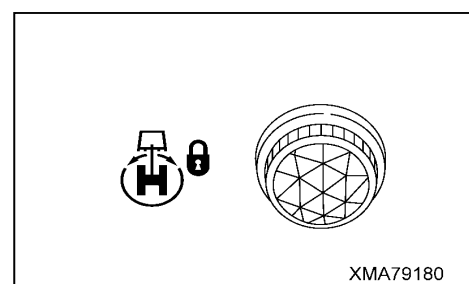



[5] REAR SWING PILOT LAMP (GREEN)

This lamp indicates the swing position of the upper revolving structure. This lamp lights up when the upper revolving structure is swung into the range where the upper revolving structure is in the opposite direction to the undercarriage structure (being swung exceeding 90 deg. to backward).

This lamp goes out when the upper revolving structure is swung into the range where the upper revolving structure is in the same direction as the undercarriage structure (being swung exceeding 90 deg. to forward).

★The figure on the right shows the range where the upper revolving structure is swung exceeding 90 deg. to backward with reference to the undercarriage structure.

The lamp stays lit while the upper revolving structure is swung in the swing range indicated with arrows.

The lamp goes out when the upper revolving structure exits this range and is swung to forward.

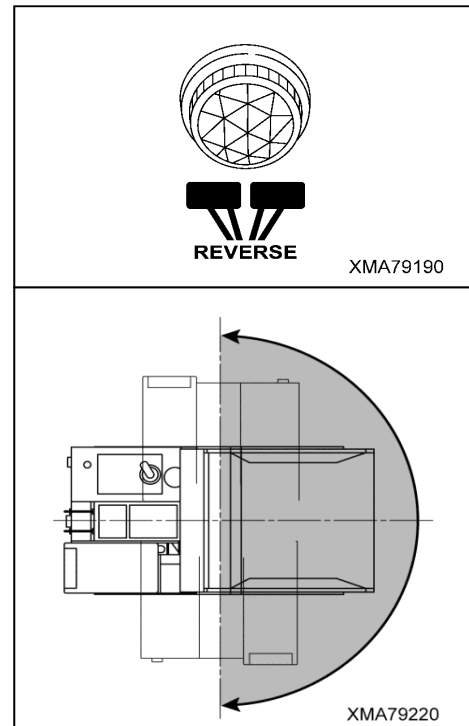

[6] CENTER PILOT LAMP (RED)

This lamp indicates that the upper revolving structure is parallel to the undercarriage structure.

This lamp lights up when the upper revolving structure faces the front or rear (backward) of the undercarriage structure.

★The figure on the right shows the machine with upper revolving structure (1) and undercarriage structure (2) facing in the same direction.

Since sprocket (A) of undercarriage structure (2) is located forward when viewed from the operator's seat, the operating direction of the travel lever and pedal matches forward/reverse direction and turning directions (left turn and right turn) of the machine.

Example:

If the travel lever or pedal is operated forward, the machine moves in reverse when viewed from the operator's seat.

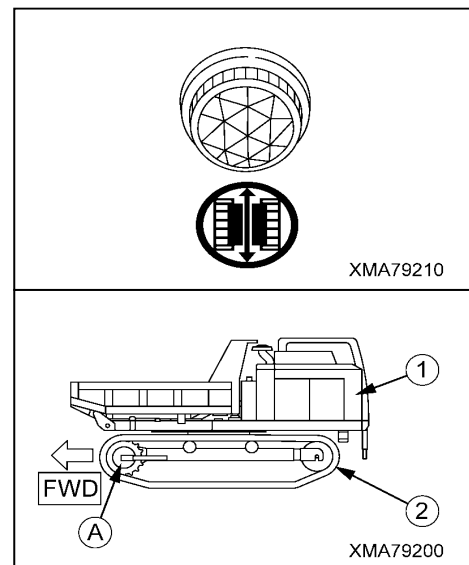

★The figure on the right shows the machine with upper revolving structure (1) facing in the opposite direction (rear) of undercarriage structure (2).

Since sprocket (A) of undercarriage structure (2) is located rearward when viewed from the operator's seat, the operating direction of the travel lever and pedal is opposite to forward/reverse direction and turning directions (left turn and right turn) of the machine.

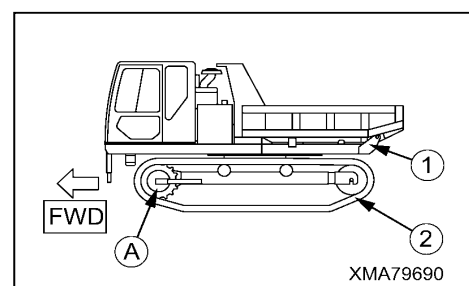

2.2 MONITOR DISPLAY

⚠ WARNING

- When traveling uphill or downhill, be sure to regularly check the tachometer to ensure the engine is running at an appropriate speed. In particular, when traveling downhill, run the machine at a slow speed as much as possible to prevent an overrun.
- During operation, check the tachometer on the monitor display screen from time to time to identify any increases or decreases in engine speed.

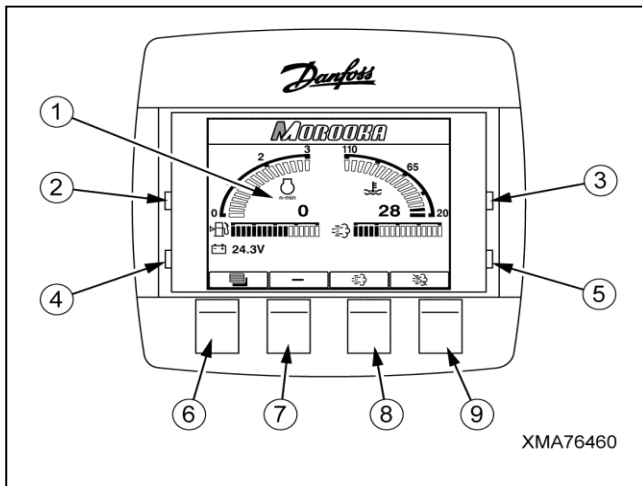

- (1) Display
- (2) Left side warning lamp (Yellow)
- (3) Right side warning lamp (Yellow)
- (4) Left side warning lamp (Red)
- (5) Right side warning lamp (Red)
- (6) Button
- (7) Button
- (8) Button
- (9) Button

The monitor display consists of a screen, two right and two left side warning lamps, and four buttons.

[1] INITIAL SCREEN DISPLAY

★When the starting switch is set to "ON" position, the opening screen is displayed for about 3 seconds, and then the indication check screen (all items) shown below is displayed for about 3 seconds.

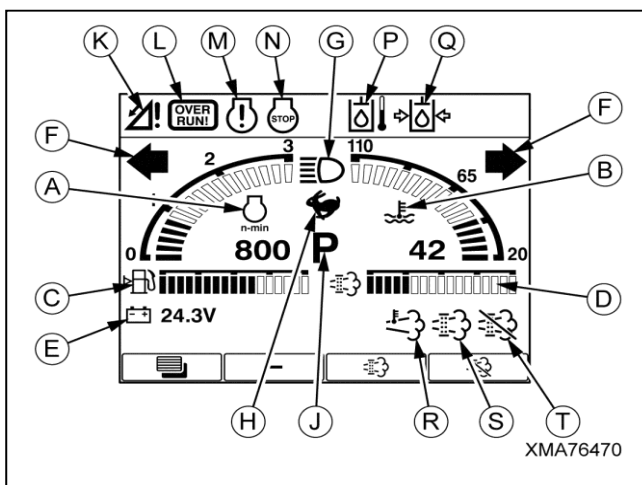

- (A) Engine speed gauge (rpm)
- (B) Engine water temperature gauge (°C)
- (C) Fuel gauge
- (D) DPF soot deposition meter
- (E) Voltage meter
- (F) Turn signal pilot lamp (Green)
- (G) Head lamp pilot lamp (blue)
- (H) High speed travel pilot lamp (Green)
- (J) Parking brake pilot lamp (Green)
- (K) Slope caution lamp (Red)
- (L) Overrun caution lamp (Red)
- (M) Engine warning lamp (Orange)
- (N) Engine stop lamp (Red)
- (P) Hydraulic oil temperature warning lamp (Orange)
- (Q) Hydraulic oil pressure warning lamp (Red)
- (R) DPF regeneration lamp (Orange)
- (S) DPF manual regeneration lamp (Orange)
- (T) DPF regeneration stop lamp (Red)



• **ENGINE SPEED METER (A)**

This meter indicates the engine speed in figures and on a scale (segments) during operation.

• **ENGINE WATER TEMPERATURE GAUGE (B)**

This gauge indicates the engine coolant temperature in figures and on a scale.

If the gauge points in the green range during operation, the engine water temperature is normal.

If the temperature increases to "100 deg. C" or above, right and left warning lamps (4) and (5) start to flash and the alarm buzzer sounds. If this alarm is issued, reduce the engine speed to a low speed and wait until the gauge points in the green range.

★ If this alarm is issued, stop the engine and check for a water leak from the radiator, clogging of radiator core, and damage and tension of the fan belt.

• **FUEL GAUGE (C)**

This gauge indicates fuel level in the fuel tank on a scale.

When the fuel gauge reads "15%" or below, a right red warning lamp (5) flashes. The lamp lights up when the gauge reads "0%".

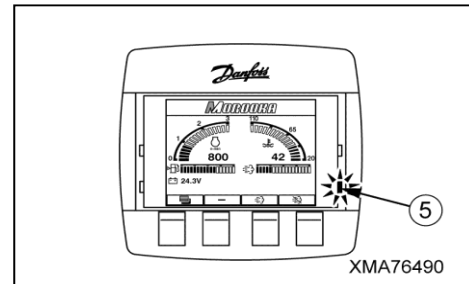
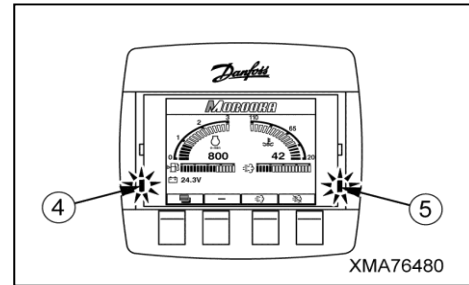

• **DPF SOOT DEPOSITION METER (D)**

This meter indicates the soot deposition level of the DPF on a scale. When the DPF soot deposition meter reads "30%", the engine automatically starts DPF regeneration.

★ Muffler (10) with built-in DPF is formed of a large cylinder and installed on the top of the engine with a special band.

★ Regeneration control type DPF (abbreviation for Diesel Particulate Filter) system traps soot (particulates) in emissions with ceramic filters built in the muffler. When the soot deposition exceeds the specified level, automatic regeneration (soot removal by burning) is executed during traveling or operation. This is called "DPF regeneration".

Repeated starting and stopping or continuous low-speed traveling of the machine can prevent completion of automatic regeneration. In this case, manual regeneration is required with the machine stopped. (DPF manual regeneration)

When manual regeneration is required, the DPF manual regeneration lamp (⚡) lights up.

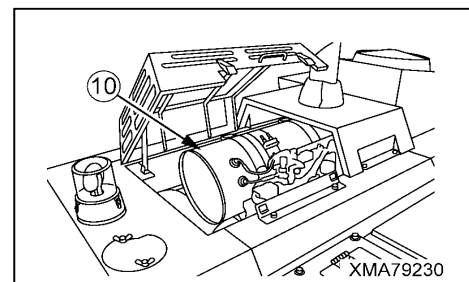

★ The figure shows the DPF with its inspection cover removed.

To open inspection cover (11), remove 2 catchers (12).

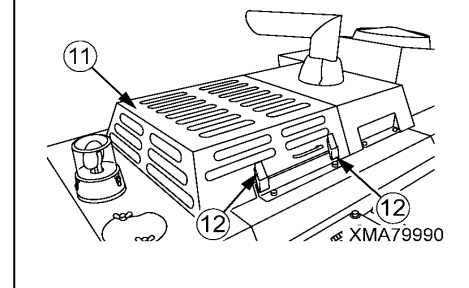



• **VOLTAGE METER (E)**

This meter indicates battery voltage in figures.

• **TURN SIGNAL PILOT LAMP (F) (←→)**

When the turn signal lever of the combination switch on the control panel is operated, the lamp on the operation side lights up.

• **HEAD LAMP PILOT LAMP (G) (☰☐)**

When the light switch of the combination switch on the control panel is operated in 2 stages, this lamp lights up.

• **HIGH SPEED TRAVEL PILOT LAMP (H) (↻)**

When the travel speed selector switch on the control panel is set to "ON" position, this lamp lights up.

• **PARKING BRAKE PILOT LAMP (J) (P)**

When the parking brake switch on the control panel is set to "ON" position, the parking brake is applied and this lamp lights up.

★When starting the engine, if the parking brake switch is not set to "ON" position, the engine cannot start.

• **SLOPE CAUTION LAMP (K) (⚠)**

⚠ WARNING

While the machine is traveling downhill in forward, if this lamp lights up, the machine inclination angle is "9 deg." or above.

Perform following operations promptly to avoid the risk of overrun, and go down the slope.

1. Return the travel lever to the "Neutral" position where the travel speed cannot increase naturally.
2. Operate the engine speed control dial to reduce the engine speed to 1,200 rpm or below.
3. If above operations cannot turn off the overrun caution lamp, the travel speed exceeds a safe speed. Immediately stop the machine and reduce the load on the dump body.

During operation, this lamp should be out.

While the machine is traveling downhill in forward, if the machine inclines "9 deg." or above, this lamp lights up to issue a warning.

• **OVERRUN CAUTION LAMP (L) (OVER)**

⚠ WARNING

• When this lamp flashes while traveling downhill, the machine is under dangerous conditions. Perform following operations promptly to avoid the risk of overrun, and go down the slope.

1. Return the travel lever to "Neutral" position and apply the brake.
2. After the machine is stopped, to reduce the load, operate the swing and dump control lever to "Raise" position to dump the load on the dump body.
3. Set the engine speed control dial to "LOW SPEED" position to lower the engine speed.
4. Move the travel lever to a position as close as possible to the "Neutral" position, and go down the slope again.

• When this lamp lights up during traveling downhill, the machine is under dangerous conditions. Urgently perform the following operations and stop the machine.

1. Return the travel lever to "Neutral" position and apply the brake.
 2. Set the engine speed control dial to "LOW SPEED" position to lower the engine speed.
 3. If you cannot stop the machine completely, press the emergency stop switch to stop the machine.
- When you have used the emergency stop switch to avoid of danger, be sure to inspect the parking brake and repair it if needed. If the brake is used as is, the parking brake may not work, incurring danger.

During operation, this lamp should be out.

When the engine speed increases to "2,300 rpm", the lamp starts to flash, and the speed increases further to "2,400 rpm", the lamp lights up to issue a warning.



• **ENGINE WARNING LAMP (M) (M)**

This lamp indicates whether the engine can be started. This lamp also warns about engine troubles.

When the starting switch is set to "ON" position, the opening screen (MOROOKA) appears and this lamp lights up. If this lamp goes out after 3 seconds, the system is normal. When the lamp does not go out, do not start the engine.

During operation, this lamp should be out.

When any trouble occurs during operation, this lamp lights up to issue a warning.

- ★ Before starting the engine, check that this lamp goes out.
- ★ If the lamp stays on and does not go out, contact your distributor.
- ★ When this warning is issued, immediately stop the operation and contact your distributor.

• **ENGINE STOP LAMP (N) (N)**

This lamp warns about engine troubles.

When the starting switch is set to "ON" position, the opening screen (MOROOKA) appears and this lamp lights up. If this lamp goes out after 3 seconds, the system is normal. When the lamp does not go out, do not start the engine.

During operation, this lamp should be out.

If any troubles occur during operation, the lamp lights up or flashes to issue a warning.

- ★ Before starting the engine, check that this lamp goes out.
 - ★ If the lamp lights up during operation, the engine power lowers. When the lamp lights up, the engine stops or will stop in a short time.
- When this warning is issued, immediately stop the operation and contact your distributor.

• **HYDRAULIC OIL TEMPERATURE WARNING LAMP (P) (P)**

This lamp warns about abnormal hydraulic oil temperature during operation.

During operation, this lamp should be out.

When the temperature of the hydraulic oil is "20 deg. C" or below, the lamp lights up and right and left orange warning lamps (2) and (3) flash.

If the temperature of the hydraulic oil exceeds "100 deg. C", the lamp lights up and right and left red warning lamps (4) and (5) flash and the alarm buzzer sounds..

- ★ If this alarm is issued, stop the engine and check the oil level in the hydraulic tank, clogging of the oil cooler core, and operating conditions of the electric fan.

• **HYDRAULIC OIL PRESSURE WARNING LAMP (Q) (Q)**

This lamp warns about a drop in the HST oil pressure during operation.

During operation, this lamp should be out.

When the HST oil pressure drops below "9.5 bar", the lamp lights up and right and left red warning lamps (4) and (5) flash and the alarm buzzer sounds.

- ★ If this warning is issued, stop the engine, and check the hydraulic oil level in the hydraulic tank, check for clogging of hydraulic oil line filters and hydraulic tank strainer, and oil leaks from the hydraulic piping.

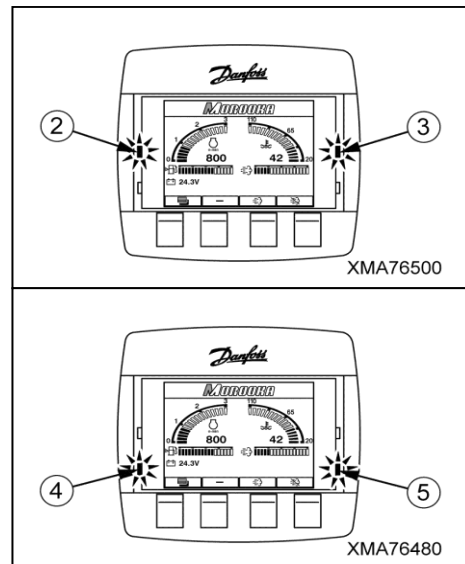



• **DPF REGENERATION LAMP (R)** (R)

This lamp indicates that the engine starts DPF regeneration during operation.

The lamp goes out when DPF regeneration completes.

If the lamp goes out during operation, DPF regeneration is not executed.

★ While DPF automatic regeneration or DPF manual regeneration is in progress, the lamp stays lit.

★ The lamp lights up when DPF soot deposition meter reads "30%".

If the engine does not start DPF regeneration with the DPF regeneration lamp lighting up, the engine has an abnormality. In this case, contact your distributor.

• **DPF MANUAL REGENERATION LAMP (S)** (S)

The lamp lights up to issue a warning when DPF soot deposition meter reads "80%".

If DPF regeneration is started manually, the lamp goes out.

During operation, this lamp should be out.

★ Immediately execute DPF manual regeneration when the lamp lights up.

★ While you can manually interrupt DPF regeneration under way, once you start DPF regeneration, it is recommended to continue DPF regeneration until the DPF soot deposition meter reads "0%".

★ The lamp may continue to light up even when the DPF soot deposition meter reads below "80%".

This is because DPF regeneration is not executed completely (DPF soot deposition meter reads "0%").

Continue DPF regeneration without interruptions until DPF soot deposition meter reads "0%".

• **DPF REGENERATION STOP LAMP (T)** (T)

This lamp lights up when the DPF regeneration stop switch at the lower section of the monitor display is set to "ON" position.

The lamp goes out when the manual regeneration switch is set to "ON" position or when the starting switch is set to "OFF" position once and then set to "ON" position.

[2] NORMAL SCREEN (Before starting engine)

★The standby screen appears about 6 seconds after the starting switch is set to "ON" position.

This screen display is shown after the starting switch is set to "ON" position and before the engine is started.

Engine speed meter (A) reads "0" and engine water temperature gauge (B) indicates "current coolant temperature".

Fuel gauge (C) and DPF soot deposition meter (D) also indicate respective "current conditions".

Parking brake pilot lamp (J) indicates that the parking brake switch is set to "ON" position in preparation for starting engine.

If the hydraulic oil temperature is "20 deg. C" or below due to low outside air temperature, hydraulic oil temperature warning lamp (P) stays displayed until the engine is started and hydraulic oil temperature rises high enough.

Hydraulic oil pressure warning lamp (Q) stays displayed until the engine is started and hydraulic oil pressure rises high enough.

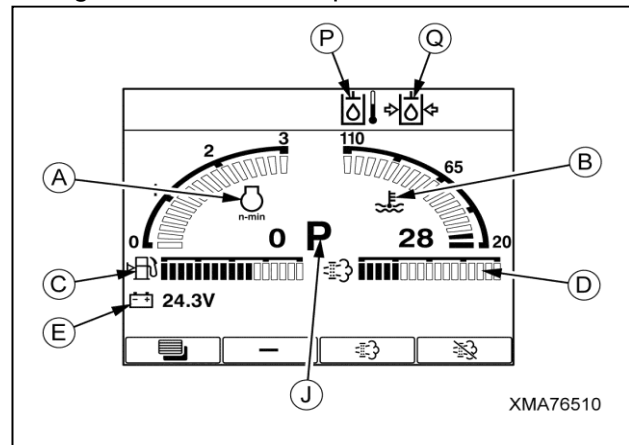

[3] NORMAL SCREEN (During engine running)

★After the engine is started, the following operation screen appears.

Engine speed meter (A) and engine water temperature gauge (B) indicate "current engine speed" and "current temperature" respectively.

Fuel gauge (C) and DPF soot deposition meter (D) also indicate respective "current conditions".

Parking brake pilot lamp (J) disappears from the above-mentioned normal standby screen because the parking brake switch is set to "OFF" position in preparation for traveling.

Hydraulic oil temperature warning lamp (P) disappears from the above-mentioned normal standby screen when the engine is started and hydraulic oil temperature rises to "20 deg. C" or above.

Hydraulic oil pressure warning lamp (Q) disappears from the above-mentioned normal standby screen when the engine is started and hydraulic oil pressure rises enough.

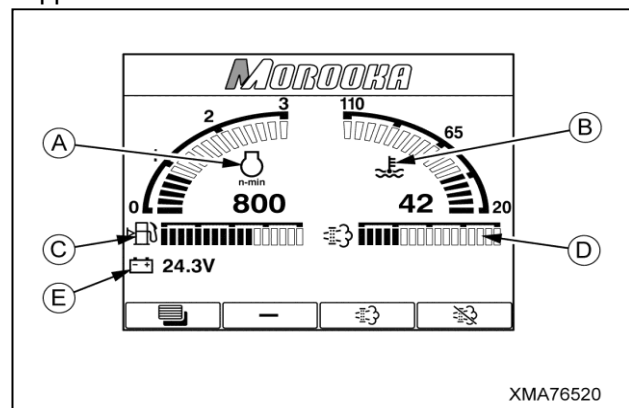

[4] DESCRIPTION OF EACH SWITCH

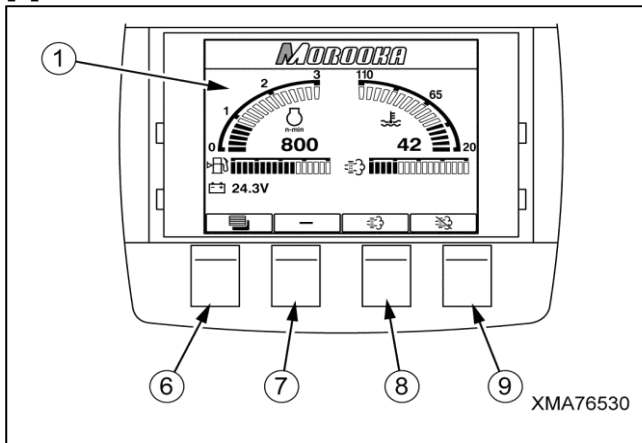

- (1) Display
- (6) Menu switch
- (7) No function is assigned.
- (8) DPF manual regeneration switch
- (9) DPF regeneration stop switch

6. MENU SWITCH (☰)

Use this to switch screens.

Five changeover screens are available.

★ Pressing this switch changes the icon of each switch. For details, see "[5] SWITCHING OF SCREEN DURING NORMAL OPERATION".

8. DPF MANUAL REGENERATION SWITCH (↻)

Use this switch to execute DPF regeneration manually.

Continue pressing this switch for 3 seconds. The engine starts DPF regeneration.

★ If DPF manual regeneration lamp (↻) lights up, the DPF soot deposition meter reads "80%" or above.

Execute D P F regeneration manually. If DPF regeneration is started manually, the lamp goes out.

★ To execute DPF manual regeneration, the engine coolant temperature is required to be "40 deg. C" or above.

For the engine speed, the engine controls its speed at the optimum level similar to the automatic regeneration.

The engine speed setting by the engine speed control dial on the control panel is ignored.

★ The lamp may continue to light up even when the DPF soot deposition meter reads below "80%".

This is because DPF regeneration is not executed completely (DPF soot deposition meter reads "0%").

Continue DPF regeneration without interruptions until DPF soot deposition meter reads "0%".

★ While you can manually interrupt DPF regeneration under way, once you start DPF regeneration, it is recommended to continue DPF regeneration until the DPF soot deposition meter reads "0%".

★ To improve work efficiency, execute DPF manual regeneration during work break (lunch hour or before/after the start of the work day).

9. DPF REGENERATION STOP SWITCH (⊘)

Use this switch to interrupt DPF regeneration under way. Use this mainly in emergencies.

Continue pressing this switch for 3 seconds. DPF regeneration stop lamp (⊘) lights up and DPF regeneration stops.

★ Use this switch to stop DPF regeneration urgently in cases where the engine suddenly starts DPF regeneration during operations and poses a problem for the work or people other than authorized persons have entered the work site during DPF regeneration.



[5] SWITCHING OF SCREEN DURING NORMAL OPERATION

The following 5 screen displays are available.

- Data: Displays current conditions of pressure at each part and engine torque.
- Maintenance: Displays the operating hours of each filter and the oil.
- Error:
- Brightness: Allows adjustment of backlight brightness of the screen.
- Language: Allows specifying language (Japanese or English) to be displayed on "Data" and "Maintenance" screens.

★"Error" screen is for the service people of your distributor, so its description is omitted here.

Follow the procedure given below when switching the screen display.

★When the starting switch is set to "OFF" position once and then set to "ON" position, "Normal standby screen" is displayed.

(1) Switching to "Data screen" display

1. "Normal standby screen" shown on the right appears in display area (1) about 6 seconds after the starting switch is set to "ON" position, and the softkey shown below is displayed at the lower part of display area (1).



2. Start the engine and press button (6) under the softkey (☰).

Display area (1) switches to "Menu selection screen" and the softkey shown below is displayed at the lower part of display area (1).



★To return to "Normal operation screen" from "Menu selection screen", press button (6) under the softkey (🏠).

3. The cursor is positioned at "Data", so press button (9) under the softkey (←).

4. Display area (1) switches to "Data screen" and the softkey shown below is displayed at the lower part of display area (1).



★On "Data screen", the current conditions of respective items on the right figure are indicated numerically.

★To return to "Menu selection screen" from "Data screen", press button (6) under the softkey (🏠).

5. To switch display area (1) to "Normal operation screen" after finishing confirmation on "Data screen", press button (6) under the softkey (🏠).

Menu selection screen

Data screen

(1) Hydraulic oil temperature
(2) Engine torque
(3) Charge pressure
(4) Engine oil pressure



(2) Switching to "Maintenance screen" display

1. "Normal standby screen" shown on the right appears in display area (1) about 6 seconds after the starting switch is set to "ON" position, and the softkey shown below is displayed at the lower part of display area (1).



2. Press button (6) under the softkey (list icon).

Display area (1) switches to "Menu selection screen" and the softkey shown below is displayed at the lower part of display area (1).



★To return to "Normal operation screen" from "Menu selection screen", press button (6) under the softkey (home icon).

3. Press button (7) or (8) under the softkey (up arrow) or (down arrow) to move the cursor to "Maintenance" item, and press button (9) under the softkey (left arrow).

4. Display area (1) switches to "Maintenance screen" and the softkey shown below is displayed at the lower part of display area (1).



★"Maintenance screen" displays operating hours up to now of each display item shown in the figure on the right. Refer to the periodic replacement time of each display item.

★To return to "Menu selection screen" from "Maintenance screen", press button (6) under the softkey (home icon).

5. After executing replacement of each display item on "Maintenance screen", set the operating hours of that display item to "0" according to the following procedures so that the next replacement time can be calculated.

(1) Press button (7) or (8) under the softkey (up arrow) or (down arrow) to move the cursor to the corresponding item.

(2) Continue pressing button (9) under the softkey (refresh icon) for 3 seconds. The operating hours of the corresponding item is set to "0000".

★Once the operating hours of a display item is set to "0", the original operating hours cannot be recovered.

Take care when selecting a display item.

★Among display items, the cursor does not move to "Total engine operating hours".

6. To switch display area (1) to "Normal operation screen" after finishing confirmation on "Maintenance screen", press button (6) under the softkey (home icon).

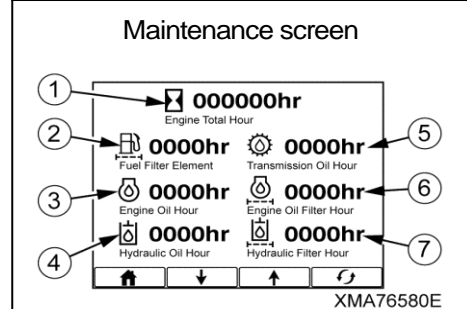
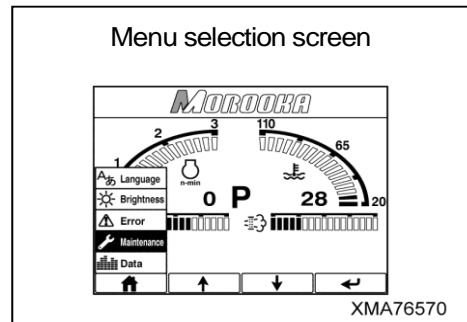
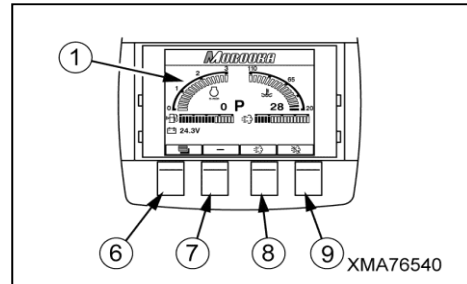

- (1) Total engine operating hours
- (2) Fuel filter element replacement time
- (3) Engine oil replacement time
- (4) Hydraulic oil replacement time
- (5) Transmission oil replacement time
- (6) Engine oil filter replacement time
- (7) Hydraulic oil filter replacement time



(3) Switching to "Brightness screen" display

1. "Normal standby screen" shown on the right appears in display area (1) about 6 seconds after the starting switch is set to "ON" position, and the softkey shown below is displayed at the lower part of display area (1).



2. Press button (6) under the softkey (☰).

Display area (1) switches to "Menu selection screen" and the softkey shown below is displayed at the lower part of display area (1).



★To return to "Normal operation screen" from "Menu selection screen", press button (6) under the softkey (🏠).

3. Press button (7) or (8) under the softkey (↑) or (↓) to move the cursor to "Brightness" item, and press button (9) under the softkey (←).

4. Display area (1) switches to "Brightness screen" and the softkey shown below is displayed at the lower part of display area (1).



At the same time, "Backlight adjustment chart" appears at the top of display area (1).

5. Press button (7) or (8) under the softkey (↑) or (↓) to adjust the backlight brightness to the desired level.

★As the graduation on "Backlight adjustment chart" increases, the backlight brightness increases. As the graduation decreases, the backlight brightness lowers.

★To return to "Menu selection screen" from "Brightness screen", press button (6) under the softkey (🏠).

6. To switch display area (1) to "Normal operation screen" after finishing confirmation on "Brightness screen", press button (6) under the softkey (🏠).

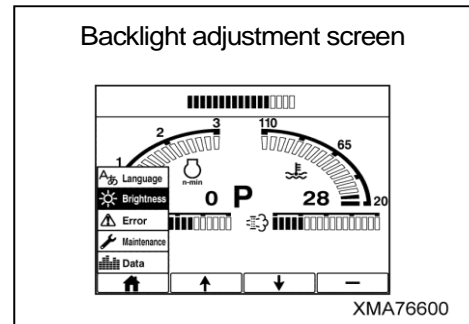
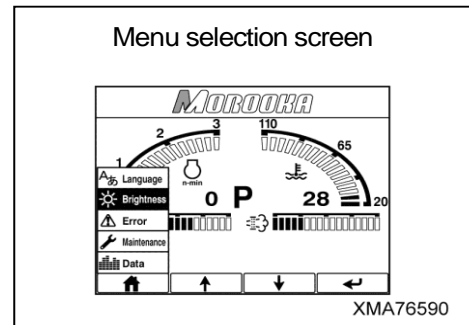
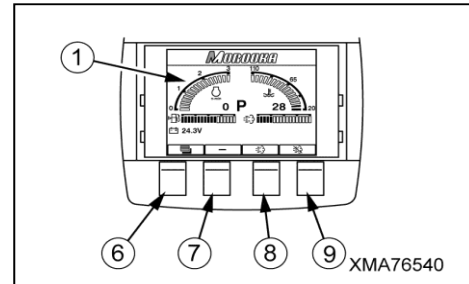

(4) Switching to "Language screen" display

★The language to be displayed on "Data screen" and "Maintenance screen" of the monitor display is set to Japanese as a factory default.

To use English display, switch the language to English according to the following procedure.

If the factory default of this machine is English, switch the language to Japanese according to the following procedure.

1. "Normal standby screen" shown on the right appears in display area (1) about 6 seconds after the starting switch is set to "ON" position, and the softkey shown below is displayed at the lower part of display area (1).



2. Press button (6) under the softkey (☰).

Display area (1) switches to "Menu selection screen" and the softkey shown below is displayed at the lower part of display area (1).



★To return to "Normal operation screen" from "Menu selection screen", press button (6) under the softkey (🏠).

3. Press button (7) or (8) under the softkey (↑) or (↓) to move the cursor in "Language" item, and press button (9) under the softkey (←).

4. Display area (1) switches to "Language screen" and the softkey shown below is displayed at the lower part of display area (1).



At the same time, "Language: Japanese" is displayed at the top of display area (1).

5. Press button (7) under the softkey (↑) to display "Language: English" at the top of display area (1), and the language to be displayed on "Data screen" and "Maintenance screen" is set to English.

Press button (8) under the softkey (↓) to display "Language: Japanese" at the top of display area (1), and the language to be displayed on "Data screen" and "Maintenance screen" is set to Japanese.

6. To switch display area (1) to "Normal operation screen" after finishing confirmation on "Language screen", press button (6) under the softkey (🏠).

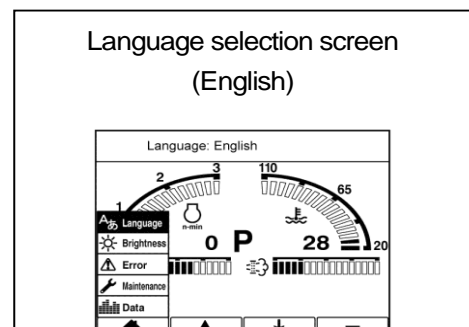
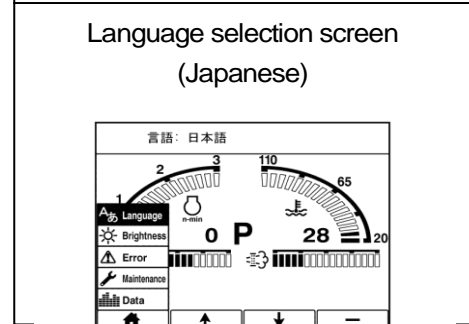
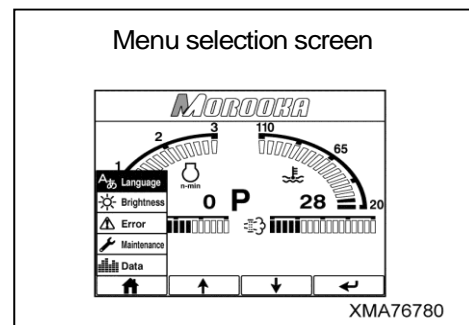
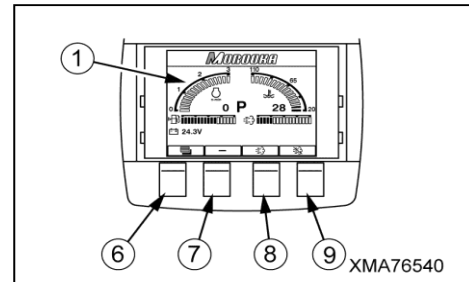

2.3 SWITCHES

[1] STARTING SWITCH

NOTICE

- Do not try to start the engine immediately when inserting the starting switch. Turn the switch to the ON position and wait for approx. 6 seconds. During this time, the engine warning lamp (orange) and engine stop lamp (red) light up of the monitor display and then go out.
- The engine cannot start when the parking brake switch is set at a position other than "ON" (STOP).

This switch is used to start and stop the engine.

- OFF: The starting key can be inserted and removed at this position. When the key is turned to this position, all the switches for the electric circuits are turned off, and the engine stops.
 - ON: Electricity flows to the charging circuit and lamp circuit.
 - START: This is the position for starting the engine (the starting motor turns). When the engine starts, release the key. The key will return automatically to the ON position.
- ★After the engine is started, do not turn the key to the OFF position except when stopping the engine.

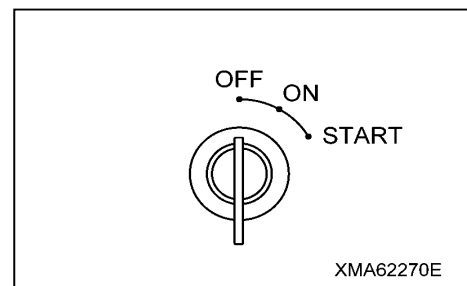

[2] ENGINE SPEED CONTROL DIAL

NOTICE

- If the engine is stopped before it has cooled down properly, there is danger that the service life of the engine parts will be reduced. Never stop the engine suddenly except in cases of emergency.
 - If the engine has overheated, do not suddenly stop it. Run the engine at a midrange speed and gradually cool it down before stopping it.
 - If you press the knob of the engine speed control dial, the engine speed will drop suddenly to low idling.
- Use this method to reduce the engine speed only when an abnormality has occurred in the engine or when there is an emergency. Do not use it for normal operations.
- When pressing the engine speed control dial knob, do not press it firmly or punch it. Doing so will damage internal parts of the dial knob.

This dial is used to control the engine speed and output.

- Turn dial knob to left (Counterclockwise): Engine runs at high speed
 - Turn dial knob to right (Clockwise): Engine runs at low speed
-
- Press dial knob: Engine speed goes down to low idling speed.

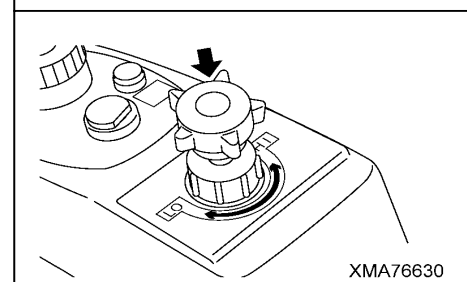
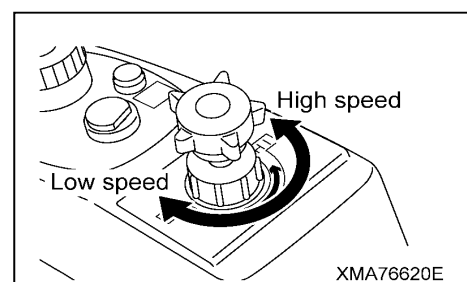



[3] HI-LO SPEED RANGE SELECTOR SWITCH

⚠ WARNING

- When traveling on slopes, always set the travel speed range to low speed.
If the machine is driven in the high speed range, it will cause the engine to overrun.
- When traveling with a load, always set the travel speed range to low speed.
If the machine is driven in the high speed range, it will cause the engine to overheat.

This switch is used to select the travel speed range.

The travel speed varies between the high-speed and low-speed ranges even when the engine speed is set at same level and the travel lever is operated to the same amount.

- Push: The travel motor changes to the high speed range and the high speed lamp on the meter box lights up.
- Push again: The travel motor changes to the low speed range and the high speed lamp on the meter box goes out.

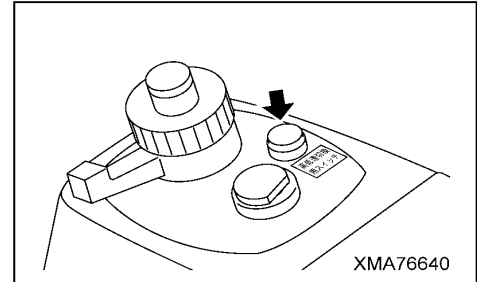

[4] PARKING BRAKE SWITCH

This switch is used to operate the parking brake inside the travel motor.

- ON (STOP): The parking brake is applied, the monitor display “Parking brake (P)” lights up, and the alarm buzzer sounds.
- OFF (RUN): The parking brake is released and the monitor display “Parking brake (P)” goes out.

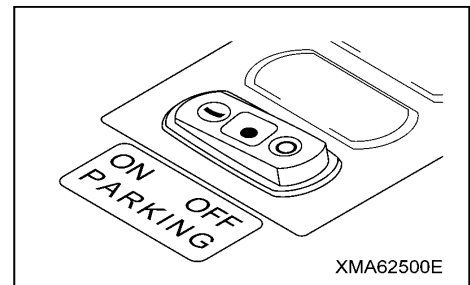

[5] COMBINATION SWITCH

This switch is used to operate the horn, head lamps, lighting, and turn signal lamps.

- Press center of switch: Horn sounds.
- Turn switch knob one stage clockwise: Instrument lighting light up.
- Turn switch knob two stages clockwise: Head lamp and the monitor display “Head lamp (≡D)” light up.
- Move lever back: Left turn signal lamp flashes and the monitor display “Left turn (←)” light up.
- Move lever forward: Right turn signal lamp flashes and the monitor display “Right turn (→)” light up.

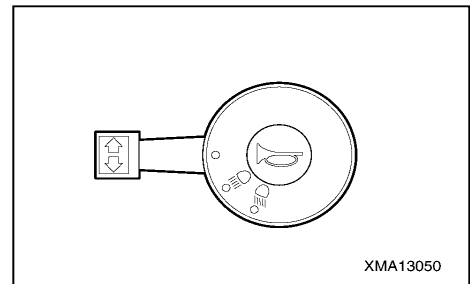

[6] SWING LOCK SWITCH

Use this switch for swing operation of the upper revolving structure.

- ON (press top of the switch)
The swing lock works to disable swing operation of the upper revolving structure.
- OFF (press lower part of the switch)
The swing lock is released to enable swing operation of the upper revolving structure.

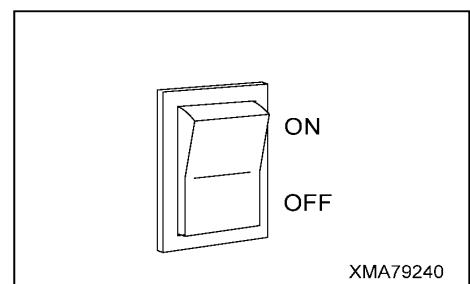



[7] EMERGENCY STOP SWITCH

⚠ WARNING

- Press the emergency stop switch in an emergency situation during traveling.
The parking brake applies to stop the machine.
- Be sure not to use the emergency stop switch except in an emergency.
The machine stops suddenly, creating the risk on injury.

NOTICE

After using the emergency stop switch during traveling, ask your distributor for an inspection of the parking brake. Using the emergency stop switch degrades the performance of the parking brake.

Use this switch to stop the machine urgently.

- Press: The parking brake applies and the machine stops urgently.
- Recover: Turn it clockwise. The switch returns to the original position and the parking brake is released allowing the machine to travel.

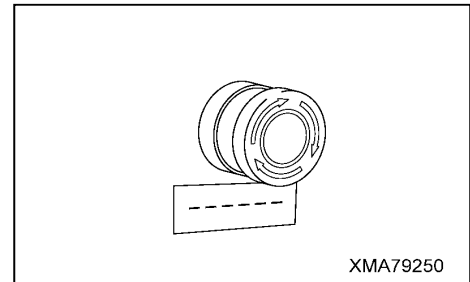

[8] TRAVEL ALARM CANCEL SWITCH

⚠ WARNING

To remind operators of safe operation, this machine is designed to sound an alarm during traveling. Be sure to confirm the safety of the surrounding area and conduct safe operation if you operate the machine with the alarm disabled.

Use this switch to stop sounding alarm.

- ON (tilt the switch upward.)
Alarm continues to sound during traveling.
- OFF (tilt the switch downward.)
Alarm stops sounding during traveling.

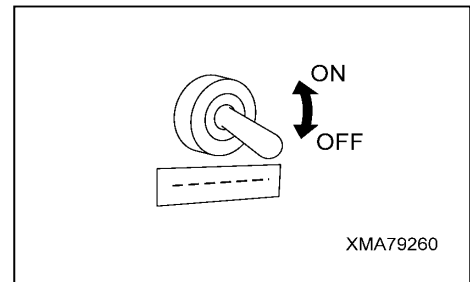

[9] SHEET SWITCH AT SWITCH PANEL

NOTICE

Some of the switches inside the seat switch are not used on this machine. The switches not marked by arrows in the diagram below do not have any function.

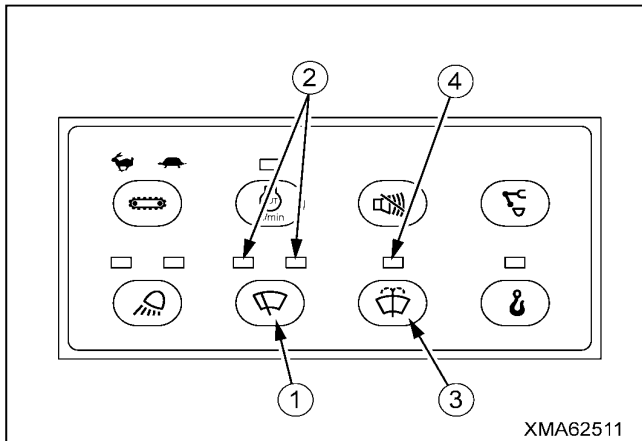

- (1) Wiper switch
- (2) Wiper indicator lamps (2 pieces)
- (3) Window washer switch
- (4) Window washer switch indicator lamp (1 piece)

(1) WIPER SWITCH & (2) INDICATOR LAMPS

CAUTION

If the wiper does not work even when the switch is turned ON, turn the switch OFF immediately and check for the cause. If the switch is left ON, it will cause damage to the motor.

This switch is used to operate the wiper.

- Press 1 time: Wiper moves intermittently once every 6 seconds and left indicator lamp (4A) lights up.
- Press 2 times: Wiper moves intermittently once every 3 seconds and right indicator lamp (4B) lights up.
- Press 3 times: Wiper moves continuously and both left and right indicator lamp (4A), (4B) light up.
- Press 4 times: Wiper stops and both left and right indicator lamp (4A), (4B) go out.

★The wiper does not work when the front window (top) is open.

Always close the front window (top) before using the wiper.

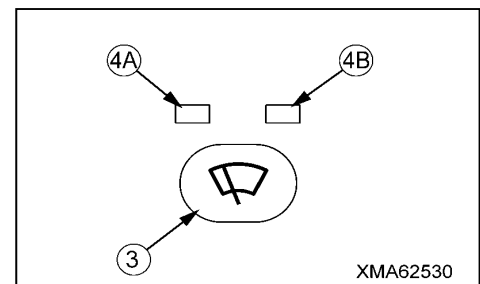

(3) WINDOW WASHER SWITCH & (4) INDICATOR LAMP

CAUTION

Do not keep the switch pressed continuously for more than 20 seconds. Do not keep the switch pressed when no washer fluid comes out. This will cause damage to the motor inside the washer tank.

This switch is used to operate the window washer.

When switch (5) is pressed, indicator lamp (6) lights up while the switch is being pressed and washer fluid is sprayed from the nozzle.

When the washer fluid is sprayed out, the wiper automatically starts.

When switch (5) is released, washer fluid stops spraying out and the wiper moves 2 or 3 times and then stops.

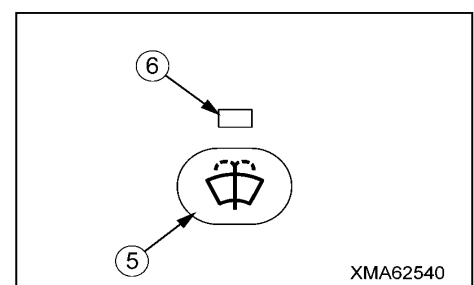



[10] HORN SWITCH

This switch is used to sound the horn.

Press the switch at the tip of the grip of the swing and dump control lever to sound the horn.

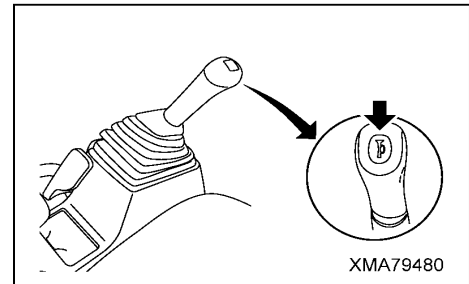

[11] CIGARETTE LIGHTER

NOTICE

When the cigarette lighter is pushed in, if it does not return to its original position after more than 30 seconds have passed, pull it out immediately. If it is left pushed in, it may cause a fire.

Use the lighter to light cigarettes.

Turn the starting switch to the ON position, push in the cigarette lighter with your finger, then release it. When the cigarette lighter is ready for use, a click can be heard and the knob returns to its original position.

Pull the cigarette lighter out and use it.

After use, push the lighter in so that the outside is level with the socket.

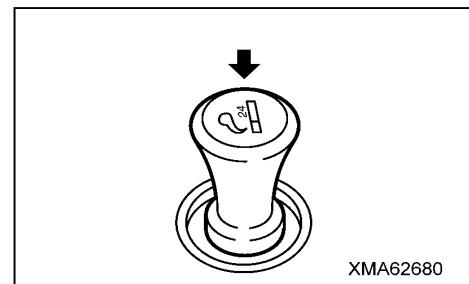

[12] ROOM LAMP (WITH SWITCH)

The room lamp is installed at the top left inside the cab.

There is a switch (1) front the room lamp.

Operate the room lamp switch as follows.

- ON (Push to left): Room lamp lights up.
- OFF (Push to right): Room lamp goes out.

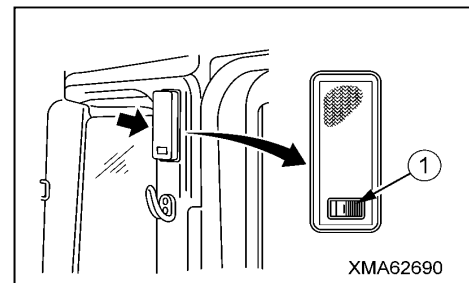

2.4 WARNING DEVICES

[1] HORN

Horn (1) is installed inside the frame to the front lower side of the cab. When the starting switch is turned ON and the horn switch at the center of the combination switch or the tip of the grip of the swing and dump control lever is pressed, horn (1) will sound continuously. Always sound the horn to warn the people in the surrounding area before starting the engine or before moving the machine off.

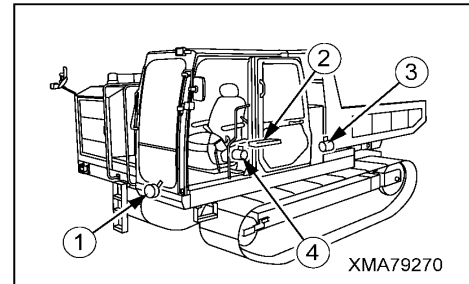

[2] SLOPE ALARM BUZZER

Slope alarm buzzer (2) is installed at the rear of the operator's cab. Slope alarm buzzer (2) automatically sounds intermittently when the inclination of a slope on which the machine is going down in forward gear exceeds 9 deg. to indicate that the inclination has become large. Slope alarm buzzer (2) is installed inside the rear box in the operator's compartment. If the angle of the slope goes above the set angle when the machine is traveling, slope alarm buzzer (2) will automatically sound intermittently to warn the operator that the angle is too large. It is dangerous to continue traveling with the dump body loaded when slope alarm buzzer (2) sounds. When traveling downhill, do as follows to prevent any danger from overrunning.

1. Operate the throttle lever to set the **engine speed to low speed**.
2. Set the travel lever **as close as possible to the "Neutral" position**, then drive the machine carefully.
3. If the load in the dump body exceeds the maximum payload or is near the maximum payload, **reduce the load**.

[3] TRAVELLING ALARM BUZZER

Traveling alarm buzzer (3) is installed on the left face inside the frame at the rear of the machine. When the engine is started and the travel lever or pedal is operated to "Forward" or "Reverse" side, the traveling alarm buzzer (3) sounds intermittently to notify persons around the machine that the machine will move.

[4] PARKING BRAKE BUZZER

Parking brake buzzer (4) is installed inside the rear box in the operator's compartment. When the starting switch is turned to ON position and the parking brake switch is operated to the ON (STOP) position, parking brake buzzer (4) will sound intermittently to inform the operator that the parking brake is applied.

2.5 SAFETY LOCL LEVER

⚠ WARNING

- Before leaving the operator's seat, be sure to stop the engine, and set the safety lock lever to "LOCK" position (safety lock bar being moved downward).
- Before starting the engine, be sure to set the safety lock lever to "LOCK" position.
- When setting the safety lock lever to "FREE" position with the engine running, take extra care not to touch the swing and dump control lever, travel lever, and travel pedal.

Use the safety lock lever to prevent the machine from moving even if the operator touches the swing and dump control lever, travel lever or travel pedal when getting on and off the machine.

When the safety lock lever (1) is set to "LOCK" position, then safety bar (2) is placed downward allowing easy getting on and off the operator's seat.

It has two operating positions: "LOCK" and "FREE"

- **LOCK:** Move safety lock lever (1) downward. This disables operation of each control lever.

In addition, since safety lock bar (2) is placed downward, this allows easy access to the operator's seat from outside the machine.

- **FREE:** Move the safety lock lever (1) upward. This enables operation of each control lever.

In addition, since the safety lock bar (2) is placed upward, this makes it difficult to leave the operator's seat to go outside the machine.

- ★ The travel lever and swing and dump control lever can be moved even when the safety lock lever is set to "LOCK" position. Since their hydraulic circuit is blocked, however, the machine and dump body cannot be moved.

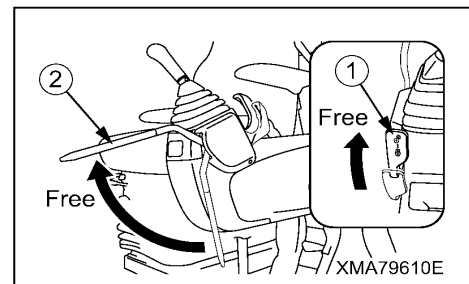
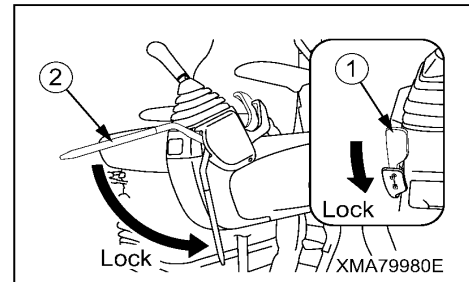

2.6 TRAVEL LEVER AND PEDAL

⚠ WARNING

- Do not make travel operations using the travel pedal in the following situations. Be sure to use the travel lever.
 - Stopping the machine
 - Passing through narrow quarters
 - Traveling uphill or downhill
 - Turning (left turn and right turn)
 - Pivot turn
- When using the travel pedal, it is difficult to maintain fine control of the machine, disabling the machine to make a sure stop and turn a corner. This can cause the machine to hit other obstacles, fall, or run over others.
- Do not place your foot on the travel pedal except when performing travel operations. If you are performing other work with your foot placed on the travel pedal, you may depress the travel pedal accidentally allowing the machine to move unexpectedly. This can cause serious injury or death.
- In addition, be sure to check that the swing lock pilot lamp (orange) lights up. If the lamp goes out, set the swing lock switch to "ON" (LOCK) position.
- When the upper revolving structure is not fixed, if the machine travels on a rough ground or a slope, the upper revolving structure may move, causing an unexpected accident.
- Check whether the center pilot lamp (red) and rear swing pilot lamp (green) light up or go out. When the center pilot lamp (red) lights up, the upper revolving structure is positioned parallel to the undercarriage structure.
 - When the rear swing pilot lamp (green) lights up, the upper revolving structure is positioned backward. In this case, forward and reverse operations of the lever and pedal are reversed with each other.
 - When switching from forward travel to reverse travel, be sure to stop the machine once, and then perform the switching operation. Abrupt shifting to REVERSE can cause engine trouble such as reverse rotation of the engine.
 - Do not operate the travel lever and pedal suddenly and greatly but be slow to move them. Abrupt operation of them makes a large impact on the machine and your body causing machine failures and injuries.
 - Do not use the travel pedal to stop the machine. Be sure to use the travel lever and do not return the travel lever excessively from the "Neutral" position. Returning the lever excessively from the "Neutral" position can cause engine trouble such as reverse rotation of the engine.
 - Do not make a turn (left turn and right turn) at high travel speeds or unnecessary pivot turn. Doing so can damage the crawler and hydraulic components and incurs the danger of a collision as well.
 - In case of an emergency, if it is required to stop the machine urgently, press the emergency stop switch on the monitor display box. This applies the parking brake and urgently stops the machine.

★The figure on the right shows the machine with upper revolving structure (1) and undercarriage structure (2) facing in the same direction.

Since sprocket (A) of undercarriage structure (2) is located forward when viewed from the operator's seat, the operating direction of the travel lever and pedal matches forward/reverse direction and turning directions (left turn and right turn) of the machine.

Example:

If the travel lever or pedal is operated forward, the machine moves in reverse when viewed from the operator's seat.

★The figure on the right shows the machine with upper revolving structure (1) facing in the opposite direction (rear) of undercarriage structure (2).

Since sprocket (A) of undercarriage structure (2) is located rearward when viewed from the operator's seat, the operating direction of the travel lever and pedal is opposite to forward/reverse direction and turning directions (left turn and right turn) of the machine.

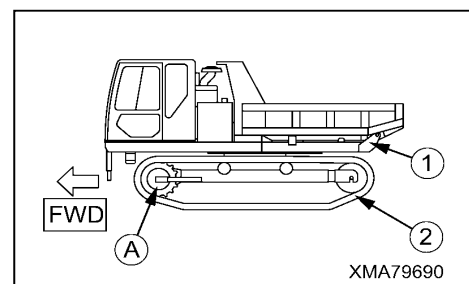
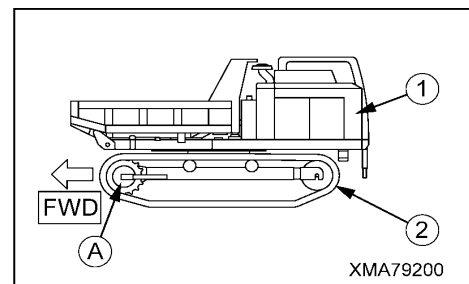



Use the travel lever or pedal to move the machine forward or in reverse, stop the machine, turn the machine and to control the travel speed of the machine.

Note that the travel lever is interconnected with the travel pedal.

★The alarm buzzer keeps sounding while the travel lever or pedal is being operated.

[1] TRAVELING STRAIGHT OR STOPPING

★When the upper revolving structure is positioned in the opposite direction (backward) to the undercarriage structure, operating directions for forward and reverse traveling are reversed with each other.

Operate both travel levers or pedals simultaneously.

- Forward traveling:
Move the lever forward. Or depress the top of the pedal.
- Reverse traveling:
Move the lever rearward. Or depress the rear of the pedal.
- Stopping:
Return the lever to "Neutral" position.

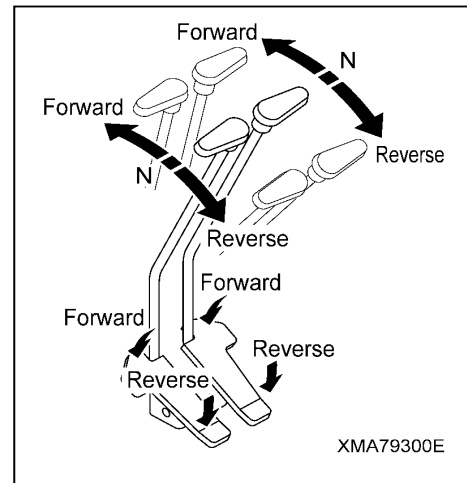

[2] TURNING (STEERING)

★Do not use the travel pedal to turn the machine.

★When the upper revolving structure is positioned in the opposite direction (backward) to the undercarriage structure, operating directions for right and left turns are reversed with each other.

While using both travel levers simultaneously, operate either travel lever.

- Left turn while traveling forward:
Move the right travel lever forward. Or move the left lever in the direction of "N".
- Right turn while traveling forward:
Move the left travel lever forward. Or move the right lever in the direction of "N".
- Left turn while traveling in reverse:
Move the right travel lever rearward. Or move the left lever in the direction of "N".
- Right turn while traveling in reverse:
Move the left travel lever rearward. Or move the right lever in the direction of "N".

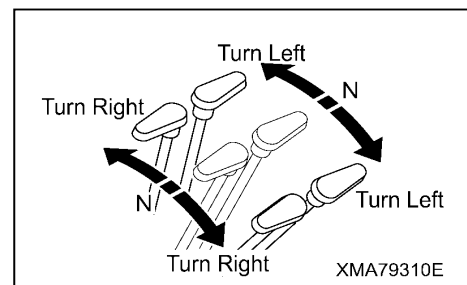

[3] TURNING GRADUALLY

Operate the left and right travel levers by a different amount.

It there is a big difference between the two levers, the machine will turn rapidly.

It there is a small difference between the two levers, the machine will turn gradually.



[4] PIVOT TURN

- ★ Do not use the travel pedal when making a pivot turn or spin turn (counter-rotation turn).
- ★ When the upper revolving structure is positioned in the opposite direction (backward) to the undercarriage structure, operating directions for right and left turns are reversed with each other.

There are the following two types of pivot turn.

• **PIVOT TURN:**

Return one travel lever fully to the “Neutral” position and operate the other travel lever in the direction of FORWARD or REVERSE.

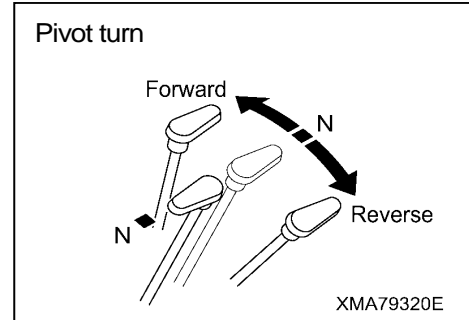

• **SPIN TURN (counter rotation turn):**

Operate the left and right travel levers in opposite directions.

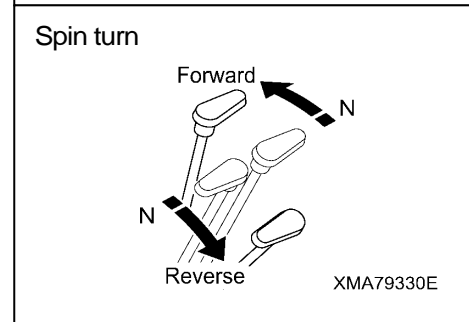

[5] CHANGING TRAVEL SPEED

Change the angle of the travel lever to change the speed.

Operate the travel lever a small amount to travel at low speed, and operate it a large amount to travel at high speed.

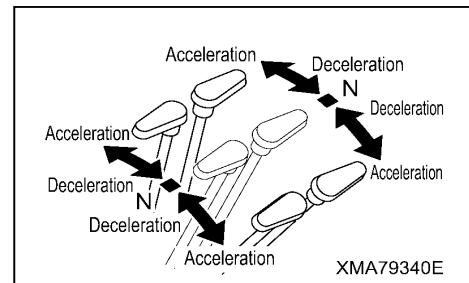



2.7 SWING AND DUMP CONTROL LEVER

★The swing and dump control lever is located on the left side of the operator's seat.

★The horn switch is provided at the top of the lever grip.

The swing and dump control lever has 4 operating positions.

Operating the lever in a front-back direction allows dumping operation of the dump body.

Operating the lever in a horizontal direction allows swing operation of the upper revolving structure.

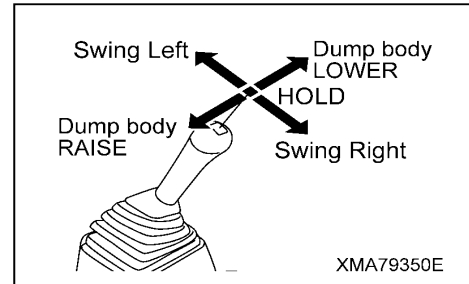

[1] SWING OPERATION (Lever operation in a horizontal direction)

⚠ WARNING

- Before swinging the upper revolving structure, be sure to stop the machine in a flat place. When you attempt to swing the upper revolving structure on a slope, the swing speed will increase unexpectedly as the upper revolving structure moves from a high position. This can cause an unexpected accident.
- If there are other persons or obstacles around the machine, enlist a guide who confirms the safety of the surrounding area and perform swing operations according to his/her instructions.
- Be slow to operate the swing and dump control lever. Swinging loaded upper revolving structure at a high speed or stopping it suddenly can cause machine failures and compromise the safety of the surrounding area as well.
- Before leaving the operator's seat, be sure to stop the engine, and set the safety lock lever to "LOCK" position.

Three lever operation positions are provided for swinging to right and left: "Swing left", "Hold", and "Swing right"

- Swing left: The upper revolving structure swings to the left (counterclockwise).
- Hold: The upper revolving structure stops at the spot and holds steady.
- Swing right: The upper revolving structure swings to the right (clockwise).

★The control lever automatically returns to "Hold" position if you release your hold.

★The yellow revolving warning lamp at the front top of the machine starts up.

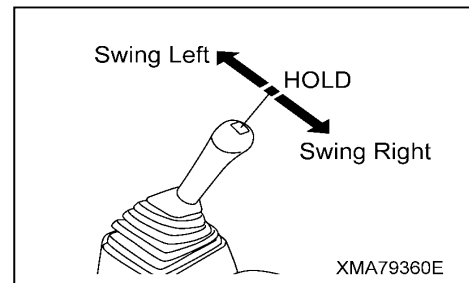

[2] DUMP OPERATION (Lever operation in front-back direction)

⚠ WARNING

- Before performing dump operation of the dump body, be sure to stop the machine in a flat place.
- Enlist a guide who confirms the safety of surrounding area and perform dump operations according to his/her instructions.
- Be slow to operate the dump control lever. Stopping the dump body suddenly or allowing it to strike against the frame can cause machine failures and compromise the safety of surrounding area as well.
- Before leaving the operator's seat with the dump body raised, be sure to stop the engine and set the safety lock lever to "LOCK" position. In addition, apply the safety bar to the dump body to prevent it from lowering.

There are 3 lever operating positions in front-back direction: "Raise", "Hold", and "Lower".

- Raise: The dump body rises.
- Hold: The dump body stops at the spot and holds steady.
- Lower: The dump body lowers.
- ★ The control lever automatically returns to "Hold" position if you release your hold.

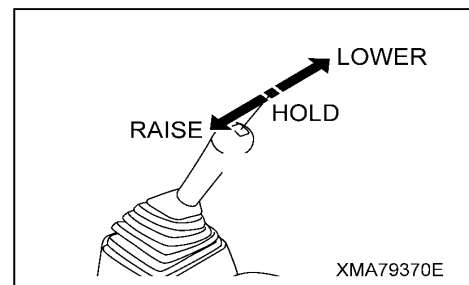

2.8 DUMP BODY SAFETY BAR

⚠ WARNING

- If it is necessary to go under the dump body to carry out inspection and maintenance, always use the safety bar to prevent the dump body from coming down.
- When using the safety bar, check that the bar is fitted securely to the dump body holder.
- The safety bar is a safety device used during inspection and maintenance. Do not use the safety bar to support the dump body when replacing the dump cylinder, valve, hydraulic hoses, or other equipment. In such cases always support the dump body with a crane.

Safety bar (1) is a device to ensure safety during operations, and is used when going under the dump body to carry out inspection and maintenance.

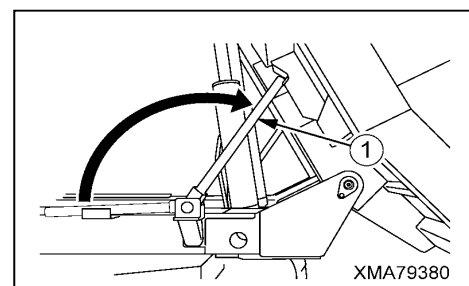



2.9 FUSE BOX IN REAR BOX

⚠ CAUTION

- Always turn the starting switch to the OFF position before replacing the fuse.
- If the fuse is blown, always check for the cause in that circuit and carry out repairs before replacing the fuse.
- When replacing the fuse, always replace it with a fuse of the same capacity.

NOTICE

Fuses are devices to prevent electrical equipment and wiring from burning out.
If a fuse is corroded or covered in white powder, always replace it.

1. Remove the fuse inspection cover (1) at the bottom of the rear box (left side) at the rear of the operator's seat.
2. After removing inspection cover (1), check or replace the fuses inside it.
3. The fuses inside the fuse box are for the circuits shown in the table below.

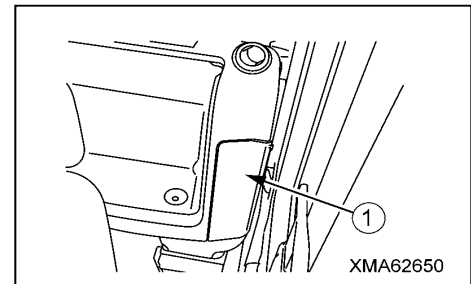

No.	Capacity	Name of circuit
1	15A	Air conditioner unit
2	10A	High-low speed range selector switch
3	10A	Cigarette lighter
4	15A	CRS pump
5	5A	Cab switch pane, radio
6	10A	Controller, monitor in cab
7	15A	Spare
8	10A	Wiper, wiper controller
9	10A	Parking brake
10	10A	Shoot sensor, starting switch
11	10A	ECM
12	20A	Swing lock solenoid, swing warning relay, safety lock lever solenoid
13	15A	Swing lock pressure switch, swing warning pressure switch
14	10A	Reverse rotating detection switch, lamp
15	10A	Safety lock lever switch
16	10A	Swing lock lamp
17	15A	Air conditioner control unit
18	10A	ECM preheating nozzle relay
19	15A	Combination switch, horn switch
20	10A	Turn signal lamp
21	10A	Hour-meter, room lamp
22	10A	Clinometer warning device
23	10A	Spare
24	10A	Spare
25	10A	Spare
26	15A	Spare
27	15A	Spare
28	25A	Spare

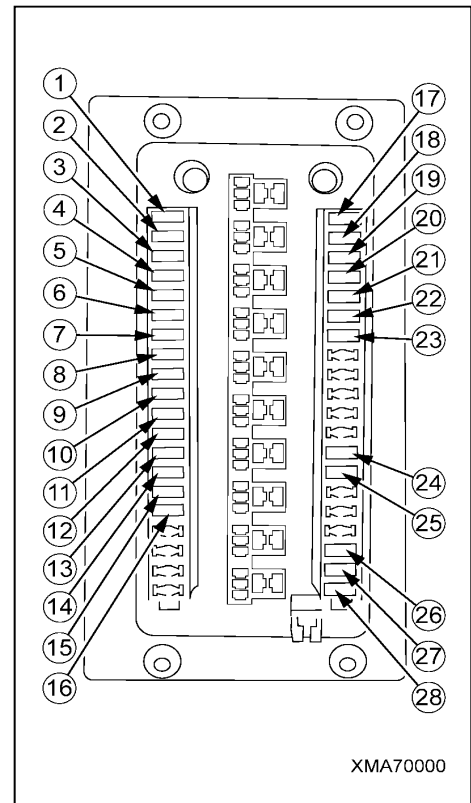

2.10 FUSES INSIDE WIRING HARNESS AT BATTERY

⚠ CAUTION

- Always turn the starting switch to the OFF position before replacing the fuse.
- If the fuse is blown, always check for the cause in that circuit and carry out repairs before replacing the fuse.
- When replacing the fuse, always replace it with a fuse of the same capacity.

NOTICE

Fuses are devices to prevent electrical equipment and wiring from burning out.
If a fuse is corroded or covered in white powder, always replace it.

★To check fuses, open the battery inspection cover. For details see "Operation 2.19 Battery inspection cover".

[1] MOUNTING POSITION AND TROUBLESHOOTING OF FUSE

• MINI-FUSE (1) (10A)

This mini-fuse is installed in the circuit between the battery (via relay box) and the starting switch (B terminal).

Check and replace this fuse if needed when the power cannot be turned on with the starting switch at "ON" position.

• SLOW BLOW FUSE (2) (75A)

This slow-blow fuse is installed in the circuit between the battery and glow relay.

Check and replace this fuse if needed when the engine does not start automatic preheating in cold weather conditions.

• SLOW BLOW FUSE (3) (100A)

This slow-blow fuse is for the ACC (accessory) installed in the circuit between the battery and main relay and fuse box in the cab.

Check and replace this fuse if needed when any problems occur in the power supply system with the engine running.

Also, check and replace this fuse if needed when the monitor display shows nothing or accessory-related components such as combination switches and air conditioner do not work with the starting switch at "ON" position.

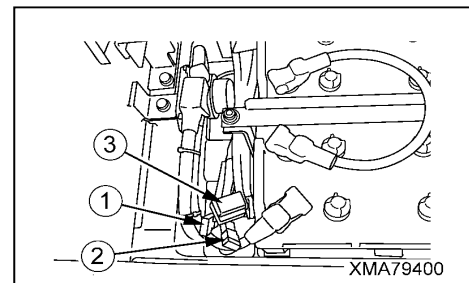

[2] METHOD OF REPLACEMENT

1. Open the battery inspection cover. For details, see 2.19 BATTERY INSPECTION COVER in the operation section.
2. Check each fuse in the wiring harness.
 - For mini-fuse (1), open the cap, take out the fuse, and then carry out inspection and replacement.
 - For slow blow fuses (2) and (3), disconnect the fuse case connector, take out the fuse, and carry out inspection and replacement.

2.11 AIR CONDITIONER

⚠ CAUTION

The air conditioner and control panel are particularly weak against water, so be careful not to let water get directly on them. This will cause failure.

2.11.1 LOCATION OF VENTS

The air conditioner is installed at the rear of the operator's compartment and provides warm air or cold air for the cab.

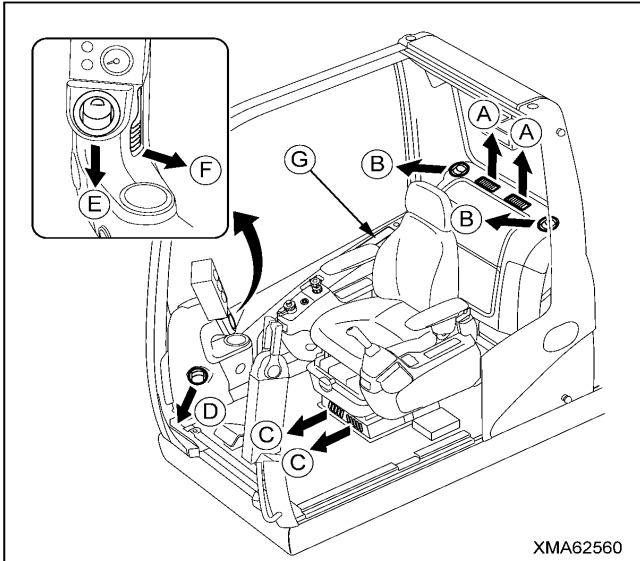

- (A) Head vent
- (B) Head vent
- (C) Foot vent
- (D) Defroster vent (Front window)
- (E) Face vent
- (F) Defroster vent (Right side window)
- (G) Control panel

★The direction of the flow of air from all the vents except for the foot vent can be controlled with the louvers.

2.11.2 NAMES AND FUNCTIONS OF PARTS ON CONTROL PANEL

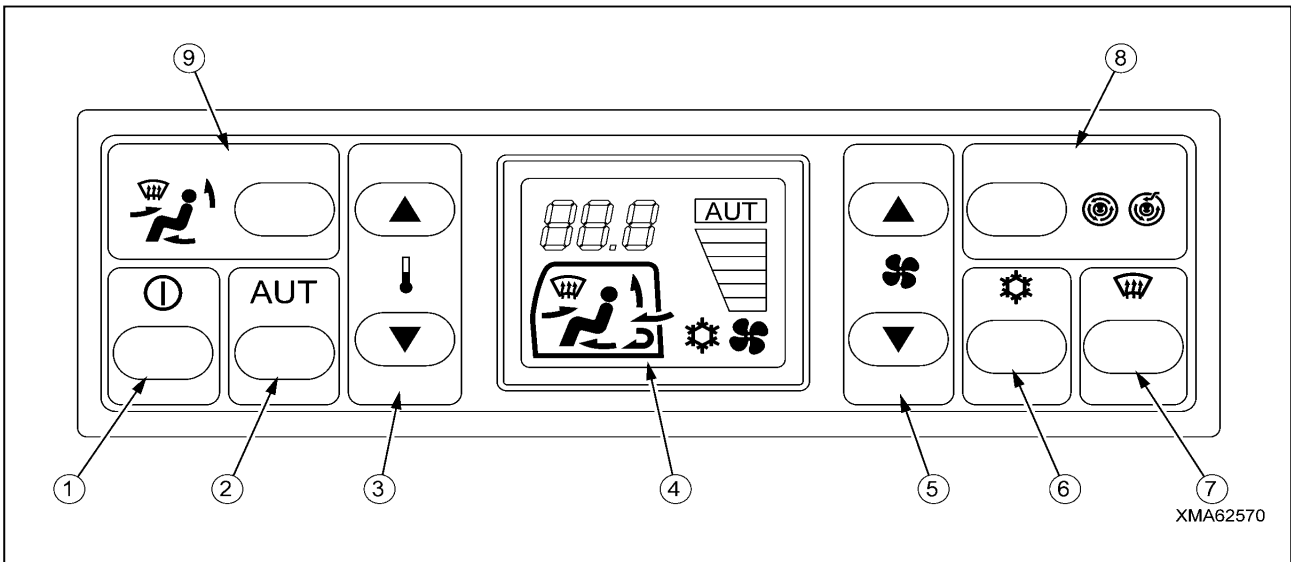

- (1) Power switch
- (2) AUT (Automatic operation) switch
- (3) Temperature control switch
- (4) LCD display
- (5) Fan speed selector switch
- (6) Compressor switch
- (7) Defroster vent switch
- (8) FRESH/RECIRC selector switch
- (9) Vent selector switch



⚠ WARNING

Do not operate the switches when your hands are wet. This will cause electric shock.

NOTICE

- When using the air conditioner, do not suddenly raise the engine speed to high speed. This will cause failure.
- Do not bring any flame close the controls.
- When cleaning the air conditioner filters, carry out the operation carefully. If the filter is clogged, the efficiency of the air conditioner will be reduced, and it will also lead to failure.

[1] POWER SWITCH (1)

This is the main switch for the air conditioner power supply.

When the switch is pressed, LCD display (4) lights up and the air conditioner starts.

If the switch is pressed again, LCD display (4) goes out and the air conditioner stops.

★If the main switch is turned OFF, when the air conditioner is started again, it will start under the same settings as when it was turned off.

[2] AUT SWITCH (2)

This switch is used for automatic operation of the air conditioner.

When the switch is pressed, the AUT LCD display (4) lights up and the air conditioner starts automatically operation at a set temperature within a range of 18 - 32°C (64 - 90°F).

★If any switch is used to make a manual setting, the automatic operation is cancelled. However, the function before the automatic setting was carried out is maintained.

★The air conditioner can be operated with this switch, but it cannot be stopped.

[3] TEMPERATURE CONTROL SWITCH (3)

This switch is used to control the temperature of the air blowing out from the vents.

The temperature set inside the cab is displayed on LCD display (4).

- To lower the set temperature, press the "▽" switch.
- To raise the set temperature, press the "△" switch.

[4] LCD DISPLAY (4)

This displays the present settings of the air conditioner.

	<p>This displays the set temperature. "25.0" means approximately 25°C (77°F).</p>		<p>This displays the speed of the air flow.</p>
	<p>This displays the vent and air intake port.</p>		<p>This displays the ON/OFF condition of the compressor.</p>
	<p>This shows that automatic operation is being used.</p>		

[5] FAN SPEED SELECTOR SWITCH (5)

This switch is used to control the speed of the air flow from the vents. The air speed can be set to 6 levels. The speed of the air flow is displayed on LCD display (4).

- To lower the air speed, press the "▽" switch.
- To raise the air speed, press the "△" switch.

[6] COMPRESSOR SWITCH (6)

This switch is used to turn the air conditioner ON.

When the switch is pressed, [⚙️] is displayed on LCD display (4), and the system switches to the air conditioner condition.

[7] DEFROSTER VENT SWITCH (7)

This switch is used to blow air out for defrosting.

When the switch is pressed, [❄️] is displayed on LCD display (4), and air for defrosting is blown out from all vents.

- Open the grille for defroster vents (D) and (F) manually.
- Close face vent (E) manually.

★It is possible to blow out air for defrosting by operating the defroster vent switch.

[Foot/defroster mode] is available for the defrosting function, so please select one of these as desired.

For details of the [Foot/defroster mode], see [9] VENT SELECTOR SWITCH.

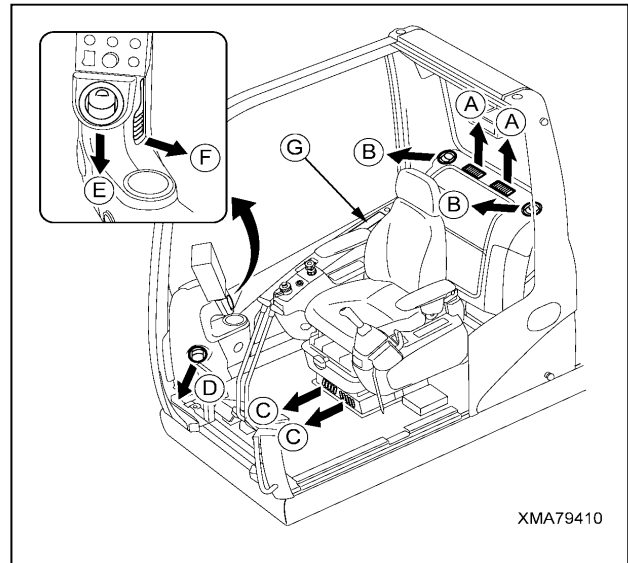

XMA79410

[8] FRESH/RECIRC SELECTOR SWITCH (8)

Use this switch to select the air intake port.

Each time the switch is pressed, the air intake switches between recirculation of the internal air and intake of fresh air from outside, and the air intake system is displayed on LCD display (4).

	<p>Air inside cab is circulated</p>		<p>Air is taken in from outside and inside of cab is pressurized.</p>
--	-------------------------------------	--	---



[9] VENT SELECTOR SWITCH (9)

This switch is used to select the vent.

The setting for the vents is displayed on LCD display (4) in the order shown in the chart below.

LCD display mode/name	Louver (vent)					
	A	B	C	D	E	F
 Vent	●	●		(Closed)	● (Closed)	(Closed)
 Bi-level	●	●	●	(Closed)	● (Closed)	(Closed)
 Foot			●			
 Foot / Defroster			●	● (Closed)	● (Closed)	● (Closed)

★When selecting the independent defroster mode, operate defroster switch (7).

★Open and close grilles (D), (E), and (F) manually.

★The ● mark shows the vent.

2.11.3 PRECAUTIONS WHEN USING AIR CONDITIONER

The air conditioner is used not only to lower the temperature when cooling but also to reduce the humidity to make the environment in the cab comfortable.

Use the air conditioner to match the ambient temperature and weather conditions, and also obey the following conditions to maintain pleasant conditions.

- It is not good for your health to cool the cab too much. Set the temperature so that it feels slightly cooler. The difference from the ambient temperature should be 5 - 6°C (41 - 43°F).
- If you smoke when the air conditioner is running, it may cause your eyes to sting. If this happens, switch to ventilation for a short time.
- When using the air conditioner with the door or window open, condensation may form inside the cab because of the humidity. Be careful when handling documents.

2.11.4 PRECAUTIONS FOR HANDLING IN OFF-SEASON

- To ensure that the air conditioner can be used for a long time to provide pleasant conditions, please ask your air-conditioner salesman to carry out inspection and maintenance before the start of the cooling season.
- In the off-season, run the air conditioner for several minutes once a week. Running the air conditioner ensures that the film of oil is maintained at all parts of the compressor, and this makes it possible to maintain the air conditioner in the optimum condition.

2.12 AM/FM RADIO

NOTICE

The radio can be used when the starting switch is at the ON position.

If the radio is operated with the engine stopped, the battery will be discharged and it may be impossible to start the engine.

Always run the engine when using the radio.

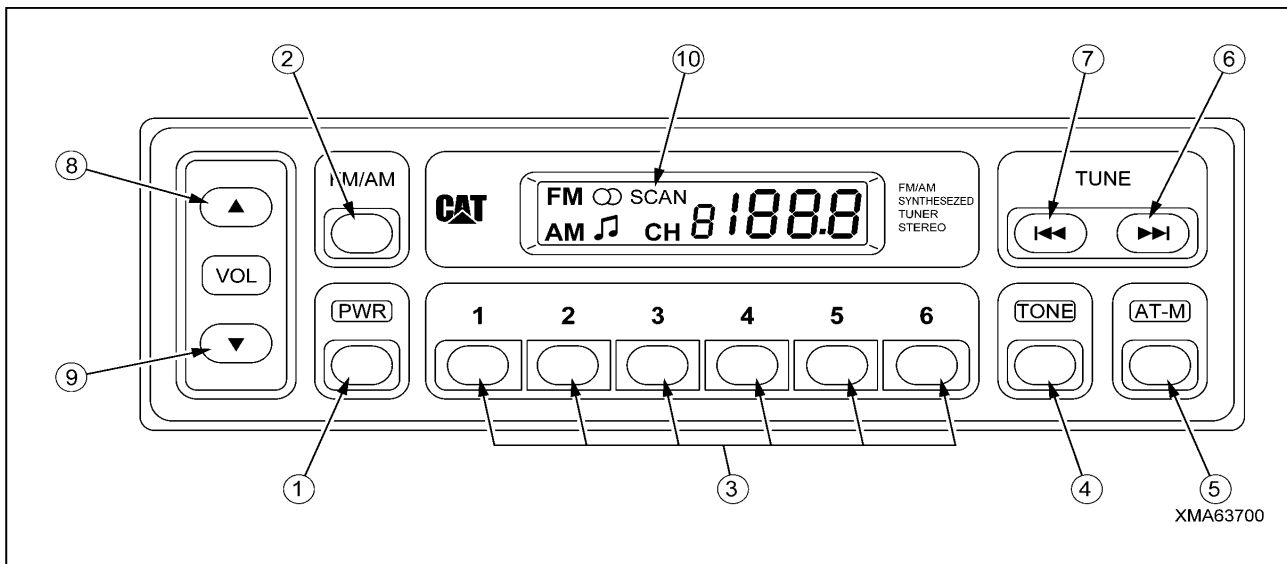

(1) Power button [PWR]

(2) AM/FM selector button [FM/AM]

(3) Preset selector button [1, 2, 3, 4, 5, 6]

(4) Tone selector button [TONE]

(5) Scan/auto memory button [AT-M]

(6) Station selector button [TUNE]

(7) Station selector button [TUNE]

(8) Volume button (up) [▲]

(9) Volume button (down) [▼]

(10) Display

★ For some buttons it is necessary to keep the button pressed for a longer time.

Keep the button pressed until a [peep] sound is heard.

(1) POWER BUTTON (1) [PWR]

Press this button to turn the power for the radio ON.

Press this button again to turn the power of the radio OFF.

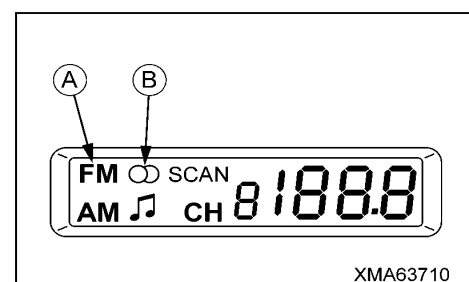

XMA63710

(2) AM/FM SELECTOR BUTTON (2) [FM/AM]

When this button is pressed, the band switches between AM and FM.

The selected band is displayed on portion A of the display. When an FM stereo broadcast is being received, a mark appears on portion B of the display.

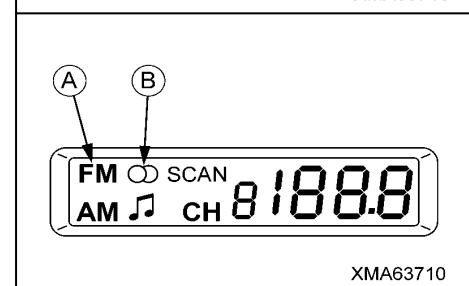

XMA63710

(3) PRESET SELECTOR BUTTON (3) [1, 2, 3, 4, 5, 6]

These buttons are used to call up the stations (frequencies) for the preset channels [1 - 6] or to set the channels to the desired frequencies.



(4) TONE SELECTOR BUTTON (4) [TONE]

Each time this button is pressed, the tone is changed. Use it to select the desired tone.

The selected tone is displayed on portion “C” of display (10) by a musical note icon when the tone is high.

When there is noise and it is difficult to hear, select low tone (the musical note icon goes out). This cuts the high tone range.

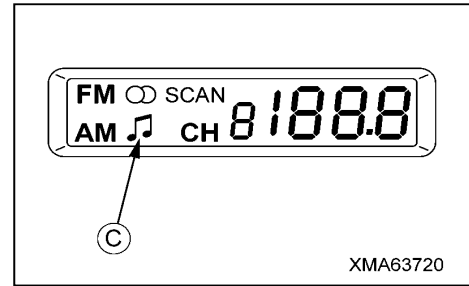

(5) SCAN/AUTO MEMORY BUTTON (5) [AT-M]

Depending how this switch is pressed, it can be used for scanning selected stations and for auto memory.

When this button is pressed, the selected stations can be scanned.

If this button is kept pressed for a long time, auto memory can be carried out.

(6) STATION SELECTOR BUTTON (6) [TUNE]

When this button is pressed, the selected station moves up to a higher frequency.

(7) STATION SELECTOR BUTTON [TUNE]

When this button is pressed, the selected station moves down to a lower frequency.

(8) VOLUME BUTTON (UP) (7) [▲]

When this button is pressed, the volume becomes higher.

(9) VOLUME BUTTON (DOWN) [▼]

When this button is pressed, the volume becomes lower.

[1] METHOD FOR SELECTING STATION

Press station selector button (6) or (7), or keep them pressed for a long time to select the station manually or automatically.

The frequency being received is displayed on portion “D” of display (10).

(1) METHOD FOR SELECTING STATION MANUALLY

Press station selector button (6) or (7) to select the desired frequency.

- When moving up to select a higher frequency, press station selector button (6).
- When moving down to select a lower frequency, press station selector button (7).

★When an AM broadcast is being received, if the button is pressed, the frequency will go up or down 9kHz.

★When an FM broadcast is being received, if the button is pressed, the frequency will go up or down 0.1MHz.

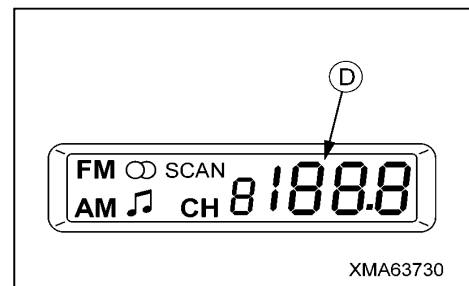

(2) METHOD FOR SELECTING STATION AUTOMATICALLY

Keep station selector button (6) or (7) pressed until a [peep] sound is heard. When a broadcast is received, it will automatically stop.

When searching for the next station, press the station selector button and keep it pressed.

- When moving up to select a higher frequency, keep station selector button (6) pressed.
- When moving down to select a lower frequency, keep station selector button (7) pressed.

To cancel the automatic station selection, press station selector button (6) or (7) again.

★If the signal reception is weak or a station is not selected, use manual selection to set to the desired frequency.

[2] METHOD OF PRESETTING

1. Select the station to be memorized with station selector button (6) or (7).

★ For details, see the previous section [2.8.1 METHOD FOR SELECTING STATION].

2. Keep any one of preset station selector buttons (3) (1 - 6) pressed until a [peep] sound is heard.

The broadcasting frequency is saved to that button. When this is done, any frequency previously saved to that button is deleted.

When the saving operation is completed, the number of the station selector button is displayed on portion "E" of the display.

★ After saving the frequency, it is possible to press preset station selector button (3) to listen to the broadcasting station saved to that button.

★ If it is desired to change the presetting, use the same procedure as when presetting a new frequency.

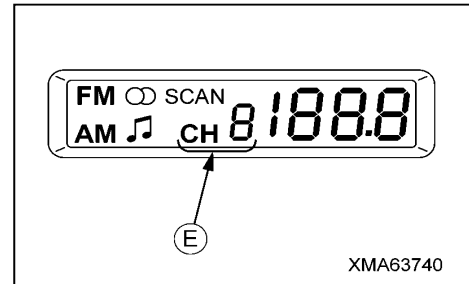

[3] METHOD OF SCANNING STATION SELECTION AND AUTO MEMORY

(1) SCANNING STATION SELECTION

When scan/auto memory button (5) is pressed, the radio receives the frequencies saved to each preset station selection button (3) for 5 seconds each. If button (5) for the desired frequency is pressed again, the radio will continue to receive that frequency. When scanning the station selection, [SCAN] lights up in portion "F" of display (10). In addition, the frequency being received is displayed in portion "D".

(2) AUTO MEMORY

If scan/auto memory button (5) is kept pressed until a [peep] sound is heard, the broadcasting stations with the best reception inside the reception ranges are automatically saved in order of frequency to each preset station selector button (3). Note that the previously saved frequencies are deleted.

[Erasure of memory]

If the connection with the battery is broken, such as during maintenance or when the radio is removed, any frequencies saved to the preset station selection buttons are lost after a few days. If this happens, please set the preset station selections again.

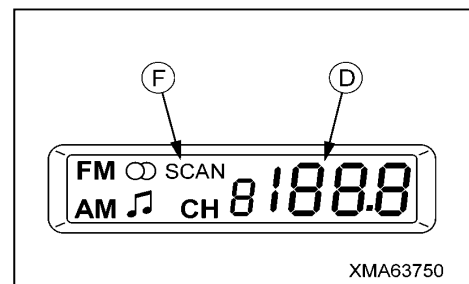

2.13 OPERATOR'S SEAT

⚠ WARNING

- Adjust the operator's seat before operations. Always adjust the operator's seat after it has been used by another operator.
- Adjust the operator's seat so that you can operate the travel lever easily with your back against the seat backrest.
- Never adjust the seat when traveling.
- Always lower the armrest before starting operation.
The armrest is installed to prevent the danger of the operator falling from the operator's seat if the machine tips at an angle when traveling.

NOTICE

Do not operate seat/console slide lever (6). The console and seat is designed so that it cannot slide to the front or rear.

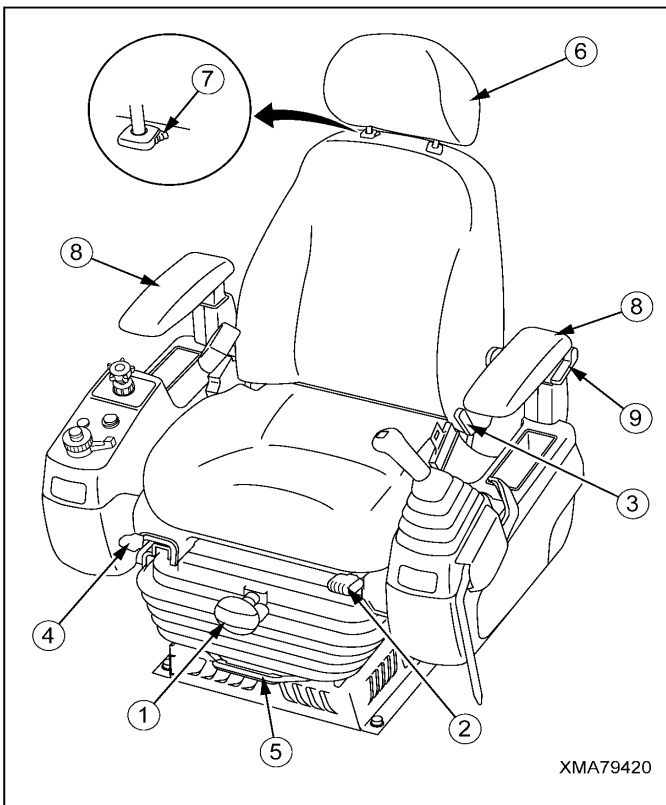

- (1) Seat height adjustment handle
- (2) Height adjustment/tilt lever
- (3) Indicator
- (4) Seat fore-and-aft adjustment lever
- (5) Seat/console fore-and-aft adjustment lever
- (6) Reclining adjustment lever
- (7) Headrest
- (8) Armrest
- (9) Armrest tilt lever
- (10) Armrest control dial

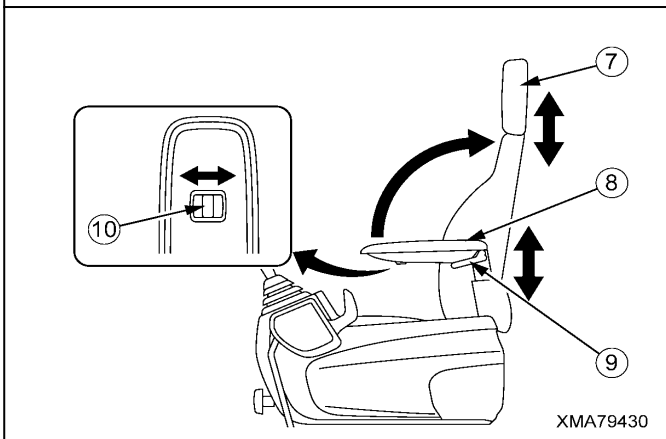



[1] SEAT HEIGHT ADJUSTMENT

Use seat height adjustment handle (1) to adjust the height.

To make the seat higher, turn handle (1) clockwise.

To make the seat lower, turn handle (1) counterclockwise.

After adjusting the height of the seat, sit in the seat and check indicator (3).

If indicator (3) is green, the seat is set to the correct weight.

If indicator (3) is red, the seat setting is outside the correct weight range. Adjust the seat height again

[2] HEIGHT ADJUSTMENT OF FRONT OF SEAT

Use height adjustment/tilt lever (2) to adjust the height of the front of the seat.

When lever (2) is pulled up, the front portion of the seat only is tilted up or down.

[3] SEAT FORE-AND-AFT ADJUSTMENT

Use seat fore-and-aft adjustment lever (4) to adjust the seat to the front or rear.

Keep lever (4) pulled up and slide the seat to the front or rear.

After adjusting to the desired position, release lever (4) and check that it is securely locked.

[4] RECLINING ADJUSTMENT

Use reclining adjustment lever (6) to adjust the reclining angle.

Keep lever (6) pulled up and adjust the seat back to the desired angle.

After adjusting, release lever (6) and secure it in position.

[5] HEADREST ADJUSTMENT

Headrest (7) can be adjusted up, down, and to the front or rear.

To adjust headrest (7) up or down, hold the headrest and move it up or down to adjust to the desired position.

To adjust headrest (7) to the front or rear, hold the headrest and move it to the front or rear to adjust to the desired position.

[6] ARMREST ADJUSTMENT

Armrest (8) can be rotated up to the rear. It is also possible to adjust the height and angle.

Use armrest tilt lever (9) and armrest control dial (10) to adjust.

To adjust the height, keep tilt lever (9) pulled up and tilt the armrest.

To adjust the angle, turn control dial (10) at the bottom of armrest (8) by hand.

It is possible to make fine adjustments of the angle of armrest (8).

2.14 SEAT BELT

⚠ WARNING

- Before fastening seat belt, always check that there is no abnormality in the belt mount or seat belt clamps. If there is any wear or damage, always replace the seat belt.
- Always adjust the seat belt and fasten it before starting operations.
The seat belt is installed to prevent the danger of the operator falling from the operator's seat if the machine tips at an angle when traveling.
- Do not use the right and left seat belt when they are twisted.
- Do not use the left or right seat belts when they are twisted.

NOTICE

When the seat belt has been used for a long period, and the belt is damaged or starting to become fluffy, or if the clamps are broken or distorted, replace with a new seat belt.
Always replace the seat belt once every three years even if there is no visible sign of abnormality.

[1] FITTING SEAT BELT

1. Sit in the operator's seat with your back against the seat backrest, then adjust the position of the operator's seat so that it is possible to operate the travel levers comfortably. For details, see 2.10 OPERATOR'S SEAT.
2. Insert tongue (1) securely into buckle (2) of the seat belt.
3. Pull the seat belt lightly to check that the tongue and buckle are securely locked.
4. Adjust seat belt (4) to fit your body.
5. When removing the seat belt, press button (3) in the center of buckle (2) and pull out tongue (1).

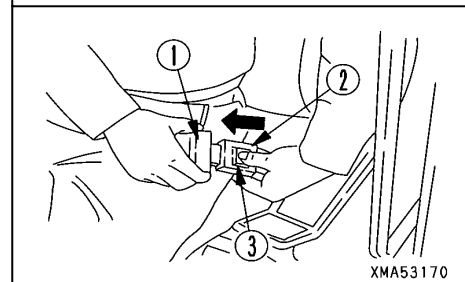
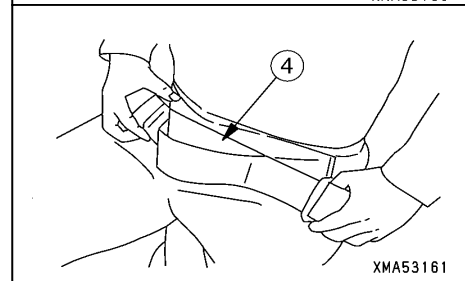
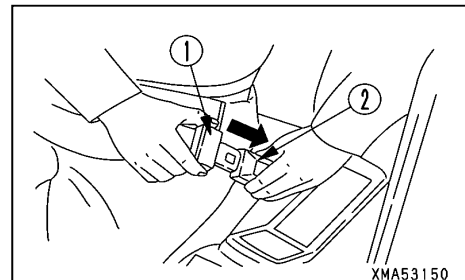

2.15 WINDOW SHIELD

⚠ WARNING

- Always lock the dump control lever before opening or closing the front window. If the dump control lever is touched by mistake, there is danger that the dump body may suddenly move down and cause serious injury or even death.
- When closing the front window, lower the front window slowly and be careful not to get your hands caught.
- When the front window is open, check that it is securely locked. If the window slides down, there is danger that it may cause serious personal injury.

2.15.1 FRONT WINDOW (UPPER)

[1] METHOD OF OPENING

1. Stop the machine on level ground, lower the dump body, then stop the engine, and then place the safety lock lever to LOCK position.
2. Move lock release lever (1) at the top of the front window in the direction of the arrow to release the lock.

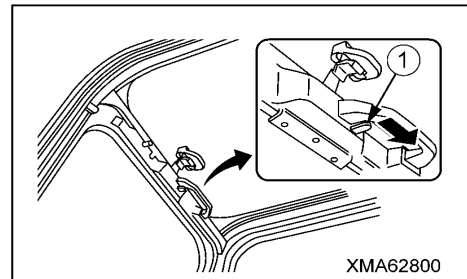

3. Firmly hold the grip at the bottom of the front window with your left hand and the grip at the top with your right hand, then lift up the front window.

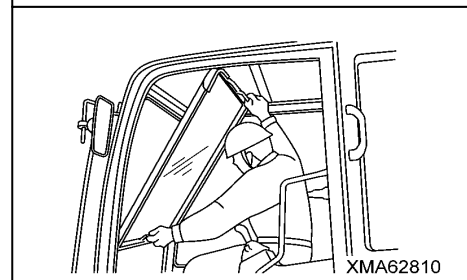

4. Move the front window to the rear of the roof, and push it against the auto lock (2) at the rear left of the roof to secure it in position.

- ★In some cases, only auxiliary lock (3) may lock properly, so hold the grips again and check that the front window is securely locked.

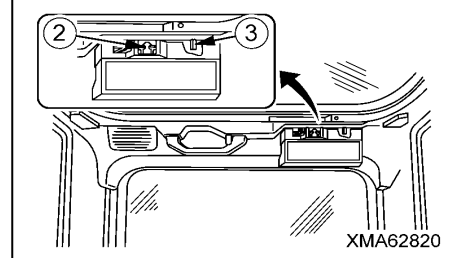

[2] WHEN CLOSING

1. Stop the machine on level ground, lower the dump body, then stop the engine, and then place the safety lock lever to LOCK position.
2. Move lock release lever (4) in the direction of the arrow.
3. Grip lock release lever (4) and move the front window slightly to the front. The lock is released.
4. Firmly hold each grip of the front window and move the front window to the front of the roof.
5. Push the front window strongly against the window frame to secure it in position.
6. Check that the front window is securely locked.

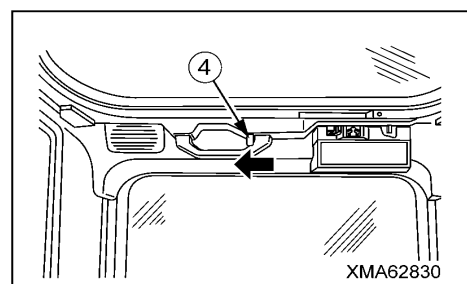

2.15.2 FRONT WINDOW (LOWER)

⚠ CAUTION

Be careful not to catch your fingers when handling the front window.

★When removing the front window (lower), open the front window (upper) before starting.

1. Lift up the front window glass and remove it from the window frame.

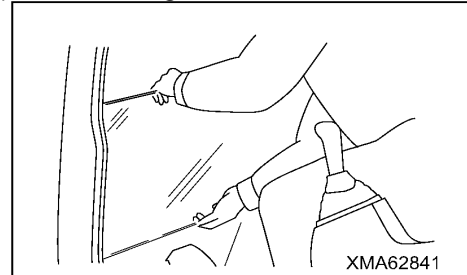

2. After removing the glass, stow it in the holder at the rear of the cab.

When stowing the window glass, insert the window glass with 2 brackets (5) at the bottom of the window frame, then fix it in position securely with top catch (6).

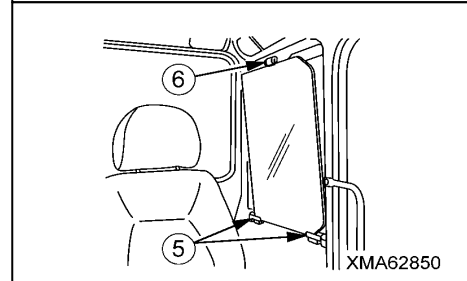

2.15.3 HATCH

Grip handle (11) and push lock (12) up and release the lock. Then push the hatch to open it.

When closing the hatch, grip handle (11) and pull down slowly to apply the lock.

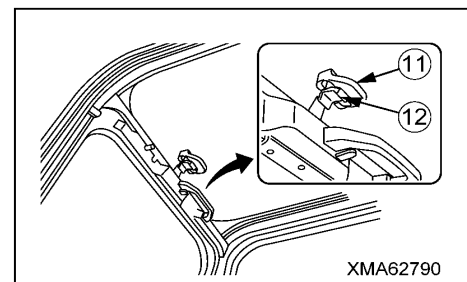

2.15.4 SLIDING WINDOW (DOOR)

Pinch the latch of the cab door glass to release the lock, then slide the glass to open or close it.

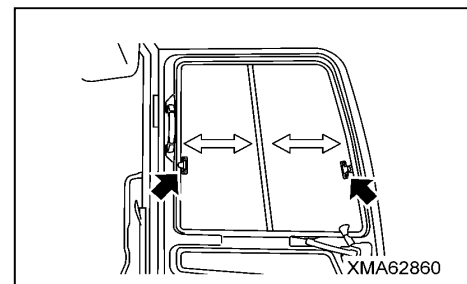

2.15.5 CAB DOOR

Push the door latch knob to the front. The door will open.

Open the door fully and secure it in position with the door catch on the side of the cab. This will improve the ventilation.

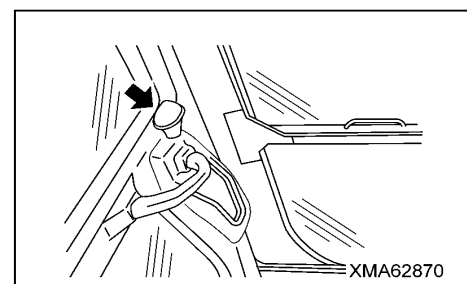



2.15.6 CAB DOOR OPEN LEVER

Push down lever (7) or lever (8).

The door is released from the door catch.

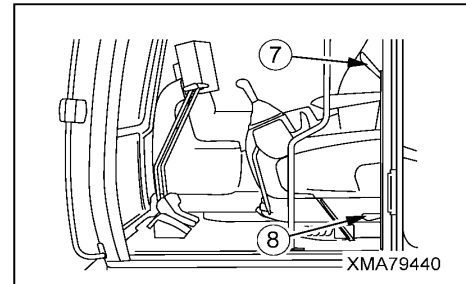

2.15.7 REAR ESCAPE WINDOW

If the cab door will not open for some reason, use the rear window as an escape exit in emergencies.

Pull ring (9), remove the seal (10) completely from the window frame rubber, then push the rear window strongly. The rear window will be removed to the outside.

- ★ Do not remove the rear window except when using it as an emergency exit.
- ★ Do not fix the rear window in position. In addition, do not place any parts or equipment on the operator's seat or around the rear window that will prevent you from escaping.
- ★ When escaping from the rear window, remove the headrest from the operator's seat to prevent it from obstructing you.

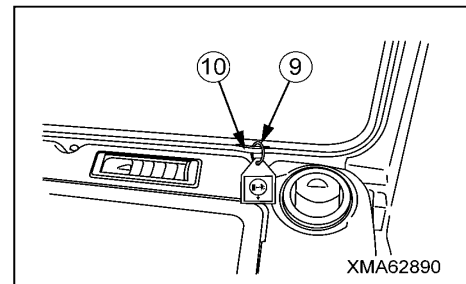

2.16 ACCESSORIES INSIDE CAB

[1] LARGE BOX

This is at the rear of the operator's compartment.
Normally, use it as a place to keep your first-aid box.

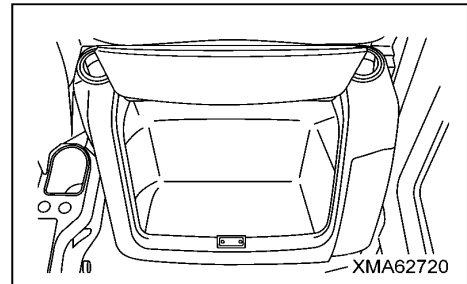

[2] COAT HOOK

This is installed at the top left inside the cab.

★Do not hang objects on the hook that will obstruct your view or hinder you when you operate the machine, or that will obstruct you when you get on or off the machine.

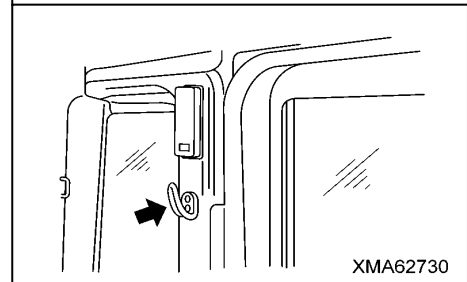

[3] ASHTRAY

This is at the rear of the dump control lever on the left console.
When using the ashtray, open the lid. When removing it, pull it up with the lid open.

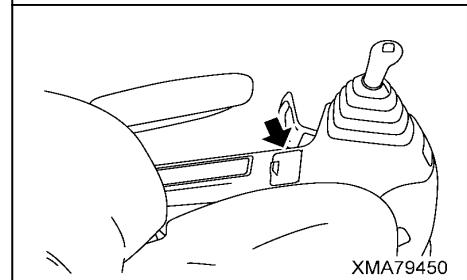

[4] DRINK HOLDER

This is under the meter box at the front right of the operator's compartment.
Use this to keep drink cans or PET bottles.

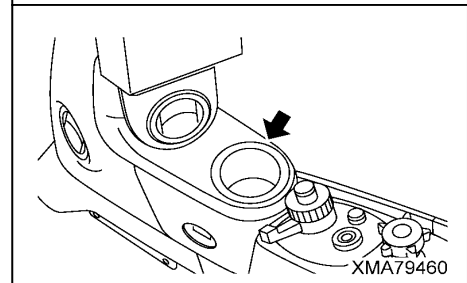

[5] GLOVE COMPARTMENT

Under armrest on left side of operator's seat
Use this to keep small objects such as cigarette packs, cell phones, or sunglasses.

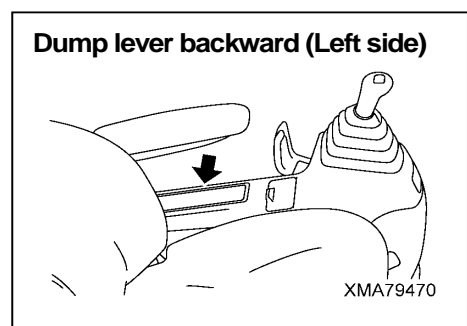

Switch box backward (Right side)

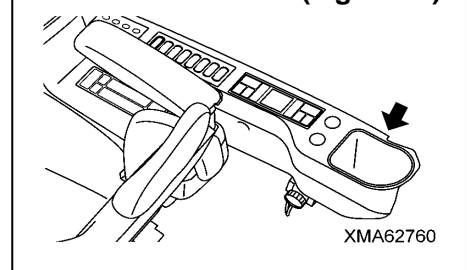

2.17 CHASSIS CENTER INSPECTION COVER

When carrying out inspection and maintenance each part of the engine and hydraulic tank, you are required to enter using the inspection step at the center of the machine.

Open the chassis center inspection cover according to the following procedure.

1. Release 2 catchers (2) at the front and rear of cover (1), grip the rear of cover (1), and pull it up to the upper left to open it fully.

★ Since cover (1) is equipped with damper (4) on its rear surface, the cover does not hit against the cab or does not fall to the original position.

2. After inspection and maintenance, grip handle (3) on the rear surface of cover (1), return the cover on the frame, and fit catcher (2) securely.

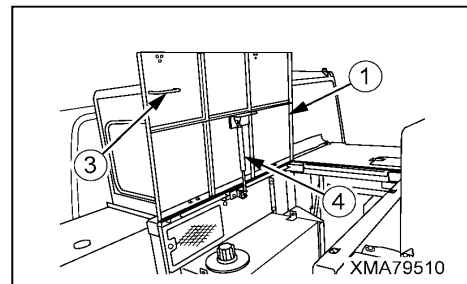
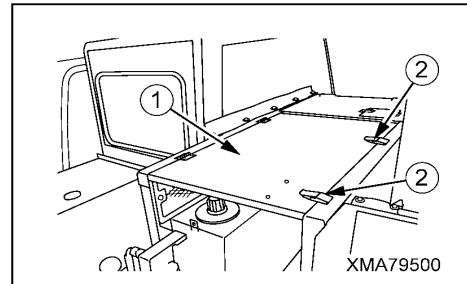

2.18 CHASSIS RIGHT SIDE INSPECTION COVER

⚠ CAUTION

Do not open both inspection covers simultaneously but open right or left inspection cover individually. After you release your hold of the handle, the inspection covers may suddenly return to their original positions due to the reaction of opening or a flap in the wind and hit against your body or hand, causing injury.

When carrying out inspection and maintenance each part of the engine and hydraulic oil line filters, open the chassis right side inspection cover according to the following procedure.

1. Unlock respective locks (3) of inspection covers (1) and (2).
2. Grip handle (4) of inspection cover (1) or (2) and unlock the lock, and open it toward you.

3. After opening inspection cover (1) or (2), remove rod (5) from the lower part of the rear surface, and install it to the lock position on the frame to secure inspection cover (1) or (2).

4. After inspection and maintenance, remove rod (5) from the lock position on the frame, and return it to the original position at the lower part of the rear surface of inspection cover (1) or (2).

5. Close inspection cover (1) or (2) and press handle (4) in.

At this time, inspection cover (1) or (2) is locked.

After that, lock respective locks (3).

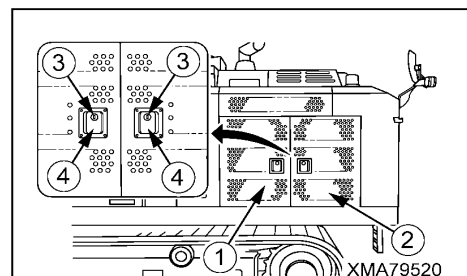

Inspection cover (1)

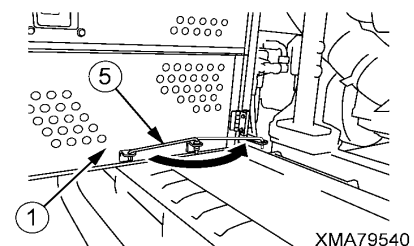

Inspection cover (2)

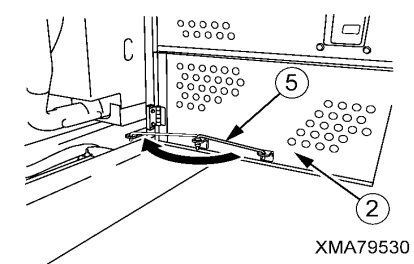

2.19 BATTERY INSPECTION COVER

When carrying out inspection and maintenance of the battery, do as follows to open the inspection cover.

1. Release 2 catches (2) of inspection cover (1), and pull handle (3) up.
2. After opening inspection cover (1), remove rod (4) from the top of the battery box, and install it to the lock position of inspection cover (1) to secure inspection cover (1).
3. After inspection and maintenance, remove rod (4) from the lock position of inspection cover (1), and return it to the original position at the top of the battery box.
4. Grip handle (3) of the inspection cover (1) and return it to the battery box, then fit catches (2).

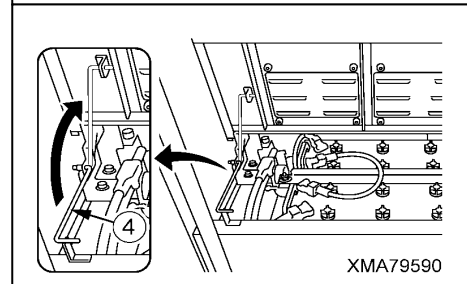
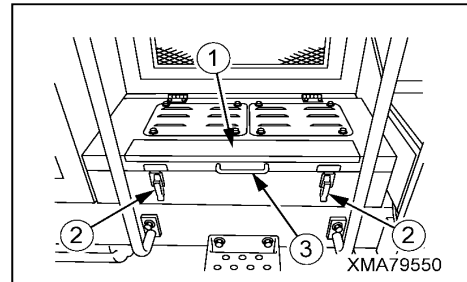

2.20 FRONT GRILL

When cleaning the radiator fins or after cooler fins, do as follows to open the front grill.

1. Press in top and bottom buttons (2) of front grill (1) to release the lock.
 2. Grip handle (3) of front grill (1) and open front grill (1) toward you.
 3. After opening front grill (1), remove rod (4) at the lower part of the rear surface of front grill (1), and install it to the lock position on the frame to secure front grill (1).
 4. After inspection and maintenance, remove rod (4) from the lock position on the frame, and return it to the original position at the lower part of the rear surface of front grill (1).
 5. Close front grill (1) and press in handle (3).
- At this time, front grill (1) is locked.

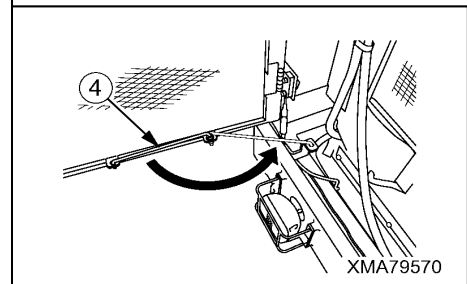
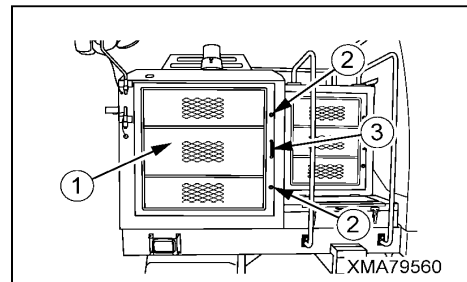

3. OPERATION

3.1 CHECK BEFORE STARTING ENGINE

[1] WALK-AROUND CHECK

⚠ WARNING

- Check carefully that there are no dead leaves, waste paper, oil, grease, or other flammable materials around the battery or the muffler, or other parts of the engine which reach high temperatures. These flammable materials can cause fire.
- Check carefully that there is no leakage of oil or fuel from the hydraulic hoses or fuel hoses. If any cracks, deformation, or other abnormalities are found, repair them immediately. These problems will cause fire, abnormalities in travel, or problems with raising or lowering the dump body.
- Always use the handrails and steps when getting on or off the machine.

Before starting the engine at the beginning of the day's work, look under and around the machine and check the following points.

- Check for dead leaves, waste paper, dust, oil, or grease at places which reach high temperatures.
- Check for loose or missing bolts, nuts, or connecting pins.
- Check for leakage of oil, fuel, or coolant.
- Check for hanging electrical wires or loose connections.

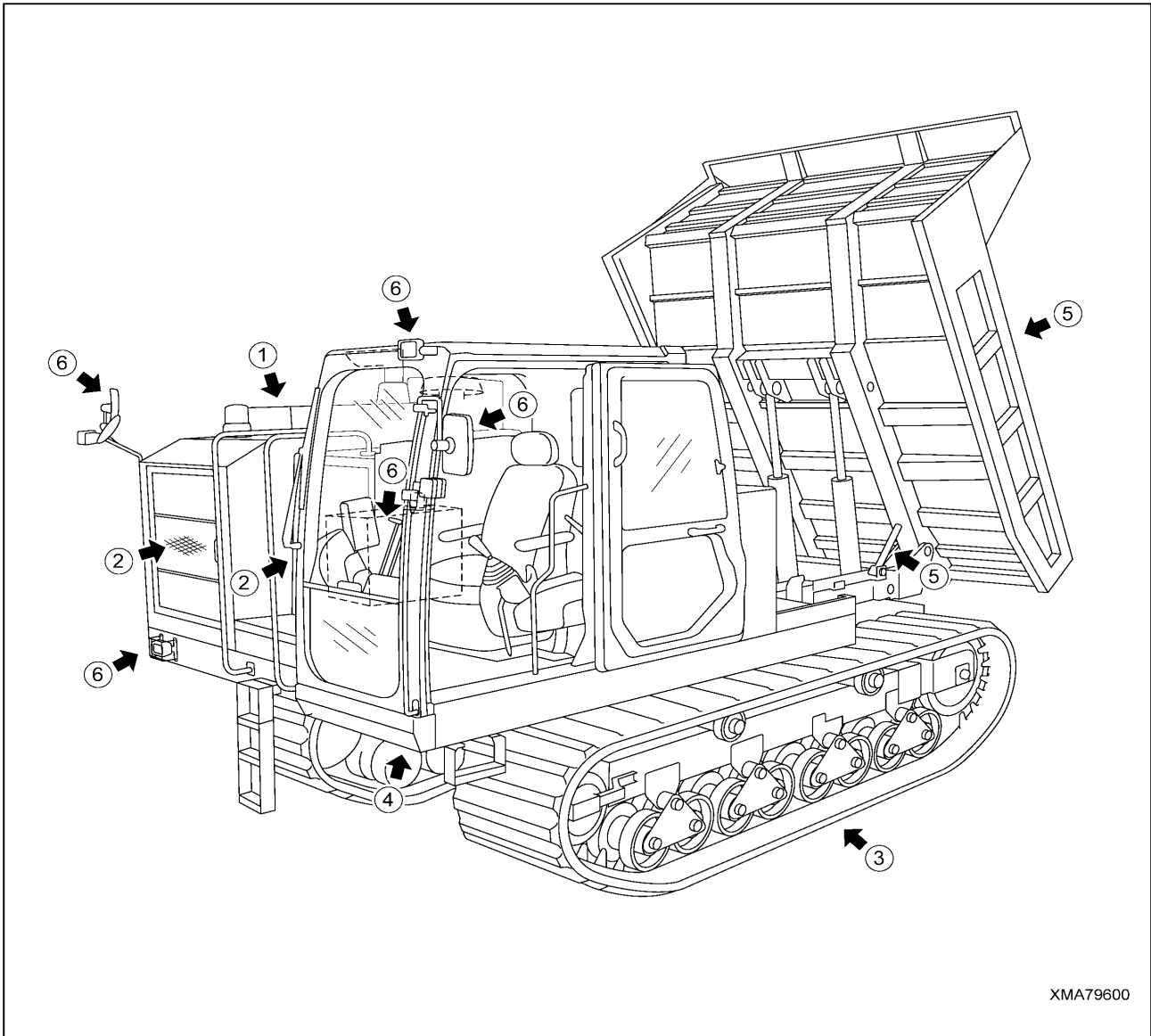

XMA79600



(1) Check around engine

Check for dead leaves, waste paper, dust, oil, grease, or other flammable materials, and check for leakage of fuel, oil, or coolant from the engine. Remove any flammable materials, and repair any abnormalities.

The DPF installed at the top of engine reaches extremely high temperatures during regeneration. Be particularly careful performing this check.

Check for hanging electrical wires, loose connections, or signs of burns around the starting motor, alternator, battery, or battery relay. Repair any abnormality.

(2) Check inside front grill

Check the front surface of the radiator and after cooler for dead leaves, waste paper, dust, or other flammable materials or materials which cause clogging. Remove any such materials.

Similarly, check and clean the front net of the oil cooler.

(3) Check undercarriage (rubber crawler, track roller, carrier roller, sprocket, idler)

Check for any wear, breaks, or cracks. Check for any loose or missing nuts or bolts. Tighten if necessary and repair any abnormalities.

(4) Check under machine

Check the hydraulic tank and fuel tank for leakage, and check the ground under the machine for traces of oil, fuel, or coolant. If any signs of leakage are found, check for the source of the leakage and repair any abnormality.

Check for loose or missing nuts and bolts from the undercover and other parts, and tighten if necessary.

Also, check for loose or missing nuts and bolts from the undercover of the upper revolving structure, and tighten them if necessary.

(5) Check dump body, safety bar

Check for any wear, breaks, or cracks. Check for any loose or missing nuts, bolts, or connecting pins. Tighten if necessary and repair any abnormalities.

Check for any leakage of oil from the hydraulic hoses or hydraulic cylinders, and repair any abnormality.

(6) Check mirrors, lamps, meter box

Check for any damage to the mirrors, lamps, meters, or monitor panel, and repair or replace if there is any abnormality.



[2] CHECKS BEFORE STARTING

Before starting the engine at the beginning of the day's work, carry out the following checks before starting and checks when required.

For details of the checks before starting, checks when required, and other maintenance, see "MAINTENANCE".

1. Checks when required

- [1] Check, adjust rubber crawler tension
- [2] Check rubber crawler for damage, wear
- [3] Clean, replace air cleaner
- [4] Clean inside of cooling system and change coolant
- [5] Check, clean radiator fins, after cooler fins, fuel cooler fins, air conditioner condenser fins
- [6] Check, clean oil cooler fins
- [7] Check refrigerant (gas) volume
- [8] Check window washer fluid level, add fluid
- [9] Clean, replace air filter of air conditioner
- [10] Clean, replace fresh filter of air conditioner

2. Checks before starting

- [1] Check coolant level, add water
- [2] Check fuel level, add fuel
- [3] Check engine lubricating oil level, add oil
- [4] Check oil level in hydraulic tank, add oil
- [5] Check dust indicator
- [6] Check, adjust air compressor belt tension
- [7] Check electric wiring
- [8] Check operation of switches, lamps, monitor display, gauges
- [9] Check operation of horn, alarm buzzer

[3] ADJUST OPERATOR'S SEAT

WARNING

- **Adjust the operator's seat before operations. Always adjust the operator's seat after it has been used by another operator.**
- **Adjust the operator's seat so that you can operate the travel lever easily with your back against the seat backrest.**
- **Never adjust the seat when traveling.**
- **Always lower the armrest and fasten the seat belt before starting operation.**
The armrest and seat belt are installed to prevent the danger of the operator falling from the operator's seat if the machine tips at an angle when traveling.

For details of adjusting the operator's seat, see "2.13 OPERATOR'S SEAT".

3. 2 HANDLING OF REGENERATION CONTROL TYPE DPF

★Muffler (10) with built-in DPF is formed of a large cylinder and installed on the top of the engine with a special band.

★Regeneration control type DPF (abbreviation for Diesel Particulate Filter) system traps soot (particulate) in emissions with ceramic filters built in the muffler. When the soot deposition exceeds the specified level, automatic regeneration (soot removal by burning) is executed during traveling or operation.

This is called "DPF regeneration".

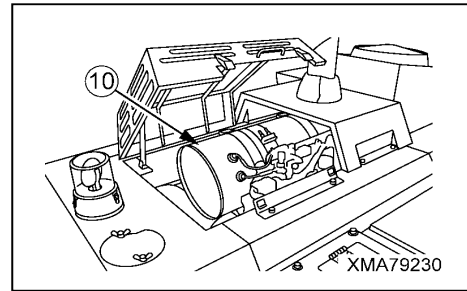

DPF regeneration is divided into 2 types: "Automatic regeneration" and "Manual regeneration".

[DPF automatic regeneration]

• "Automatic regeneration" is started when DPF soot deposition meter (1) on the monitor display reads near "30%".

Watch for the indication of DPF soot deposition meter (1) during operating the machine.

When DPF soot deposition meter (1) reads "30%", DPF regeneration lamp (⚡) (5) lights up to issue a warning and the engine automatically starts "DPF regeneration".

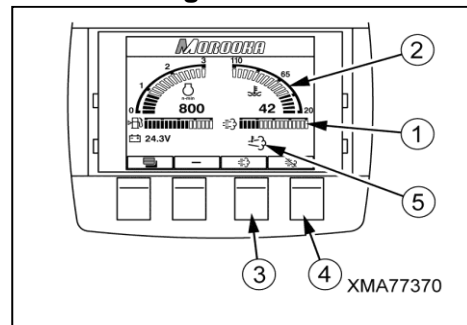

[DPF manual regeneration]

• While you can execute DPF manual regeneration if DPF soot deposition meter (1) on the monitor display reads "15 %" or above, DPF automatic regeneration starts if DPF soot deposition meter reads "30%".

Therefore, as long as DPF automatic regeneration is executed normally, DPF manual regeneration is not needed.

• While DPF automatic regeneration is in progress, if the machine repeats starting and stopping or continues low-speed traveling, DPF automatic regeneration may not complete successfully. Repeated interruption and stoppage of DPF automatic regeneration also increases DPF soot deposition.

When DPF soot deposition meter (1) reads "80%" and above, DPF manual regeneration lamp (⚡) (6) lights up to issue a warning that prompts you to execute DPF manual regeneration.

If DPF manual regeneration lamp (⚡) (6) lights up, promptly execute DPF manual regeneration.

• When DPF manual regeneration lamp (⚡) (6) lights up, if the machine is used continuously without executing DPF manual regeneration, the DPF soot deposition increases further and the following phenomena occur.

- DPF soot deposition meter (1) reads above "100%" and engine power drops.

- DPF manual regeneration lamp (⚡) (6) lights up and engine warning lamp (⚡) (8) flashes to issue a warning.

• When DPF soot deposition increases further,

- DPF manual regeneration lamp (⚡) (6) lights up.

- Engine warning lamp (⚡) (8) flashes.

- Engine stop lamp (⚡) (9) lights up.

Lighting up of engine stop lamp (⚡) (9) indicates that DPF regeneration becomes impossible, so the engine stops.

In this case, the DPF needs to be replaced. In this case, contact your distributor.

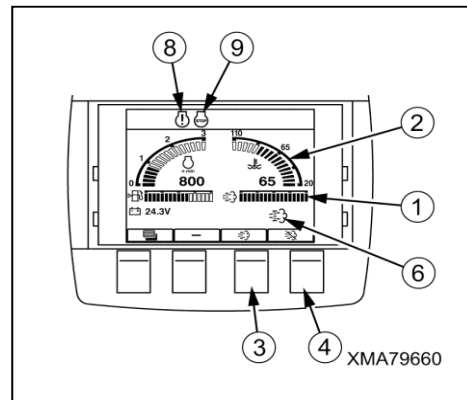
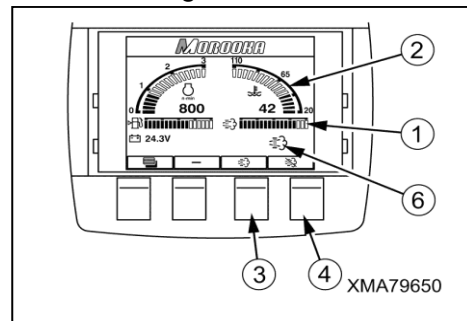

[1] DPF AUTOMATIC REGENERATION

⚠ WARNING

When DPF regeneration starts, the air temperature around the muffler (with built-in DPF) rises extremely high. If you touch such a high-temperature muffler or exhaust pipe, you can get burned or it can cause a fire.

Observe the following precautions in preparation for DPF automatic regeneration.

- Before starting work for the day, make sure that flammable items such as dead leaves, dried grass, wood debris, paper, oil, etc. are not attached to the muffler and exhaust pipe, and their surrounding area. Be sure to remove them if attached.
- After DPF automatic regeneration starts, observe the following precautions.
 - Move and park the machine in a safe, flat, and large open space where there are no flammable wood and living trees around the machine.
 - Avoid buildings with poor ventilation. Such a building can cause carbon monoxide poisoning.
 - Make sure that no flammable items are around the muffler and exhaust pipe. Remove them if they are there.
 - Take measures to prevent people from accessing the machine.
 - Stop DPF regeneration if anyone other than authorized personnel enters the space during DPF regeneration.
 - If you must leave the machine during DPF regeneration, be sure to stop DPF regeneration at once and stop the engine.
- After finishing work for the day, make sure that flammable items such as dead leaves, dried grass, wood debris, paper, oil, etc. are not attached to the muffler and exhaust pipe. Be sure to remove them if attached.

NOTICE

- When DPF soot deposition meter (1) reads "30%", DPF regeneration lamp (⚡) (5) lights up to issue a warning and the engine automatically starts "DPF regeneration".
- While you can manually interrupt DPF regeneration under way, once you start DPF regeneration, it is recommended to continue DPF regeneration until DPF soot deposition meter (1) reads "0%".
- While the machine can be used for normal work during DPF regeneration, do not operate the machine for the work but park it as far away.
Repeated starting and stopping or continuous low-speed traveling of the machine can prevent completion of automatic regeneration. In this case, the DPF manual regeneration lamp (⚡) (5) lights up to alert that manual regeneration is needed.

(1) Starting DPF automatic regeneration

When DPF soot deposition meter (1) reads "30%", DPF regeneration lamp (⚡) (5) lights up to issue a warning and the engine automatically starts "DPF regeneration".

★ DPF regeneration lamp (⚡) (5) stays lit during DPF automatic regeneration. When DPF regeneration completes, DPF regeneration lamp (⚡) (5) goes out.

★ If the engine does not start DPF regeneration with DPF regeneration lamp (⚡) (5) lighting up, the engine has an abnormality.

In this instance, contact your distributor.

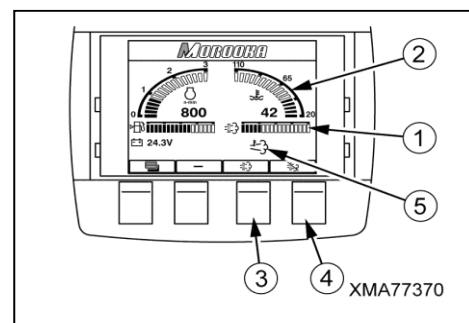

(2) How to interrupt or stop DPF automatic regeneration

When you are required to stop DPF regeneration forcibly in an emergency, continue pressing DPF regeneration stop switch (4) for "3 seconds". The engine stops DPF regeneration. At the same time, DPF regeneration lamp (⚡) (5) goes out and DPF regeneration stop lamp (🚫) (7) lights up.

★ Use this switch to stop DPF regeneration urgently in cases where the engine suddenly starts DPF regeneration during work and poses a problem for the work or people other than authorized persons enter the work site during DPF regeneration.

★ To restart DPF regeneration, continue pressing DPF manual regeneration switch (3) for "3 seconds". The engine restarts DPF regeneration. At the same time, DPF regeneration stop lamp (🚫) (7) goes out.

★ To stop DPF regeneration, turn the starting switch to "OFF" position to stop the engine.

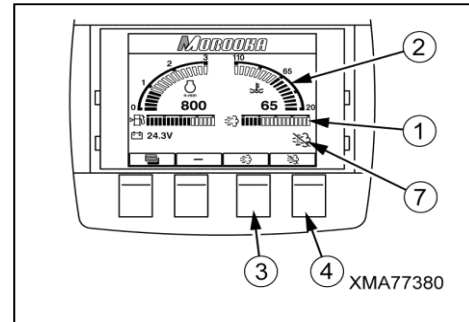



[2] HOW TO EXECUTE DPF MANUAL REGENERATION

⚠ WARNING

When DPF regeneration starts, the air temperature around the muffler (with built-in DPF) rises extremely high. If you touch such a high-temperature muffler or exhaust pipe, you can get burned or it can cause a fire.

Observe the following precautions in preparation for DPF manual regeneration.

- Before starting DPF manual regeneration, make sure that flammable items such as dead leaves, dried grass, wood debris, paper, oil, etc. are not attached to the muffler and exhaust pipe. Be sure to remove them if attached.
- Observe the following precautions in preparation for DPF manual regeneration.
 - Move and park the machine in a safe, flat, and large open space where there are no flammable wood and living trees around the machine.
 - Avoid buildings with poor ventilation. Such a building can cause carbon monoxide poisoning.
 - Make sure that no flammable items are around the muffler and exhaust pipe. Remove them if they are there.
 - Take measures to prevent people from accessing the machine.
 - Stop DPF regeneration if anyone other than authorized personnel enters the space during DPF regeneration.
 - If you are compelled to leave the machine during DPF regeneration, be sure to stop DPF regeneration at once and stop the engine.
- After finishing DPF manual regeneration, make sure that flammable items such as dead leaves, dried grass, wood debris, paper, oil, etc. are not attached to the muffler and exhaust pipe, and their surrounding area. Be sure to remove them if attached.

⚠ CAUTION

- When DPF manual regeneration lamp (⚠) lights up, the DPF soot deposition meter reads "80%" or above. Under this condition, execute DPF manual regeneration. The lamp goes out when DPF manual regeneration starts.
- If the machine is used continuously with DPF soot deposition meter reading "100%" or above (DPF manual regeneration lamp (⚠) lights up and engine warning lamp (⚠) flashes), the engine power drops. If DPF soot deposition increases further, DPF manual regeneration lamp (⚠) lights up, engine warning lamp (⚠) flashes, and engine stop lamp (⚠) lights up. In this condition, because DPF regeneration cannot be executed, the engine stops. In this case, the DPF needs to be replaced with a new one. Contact your distributor.

NOTICE

- The lower DPF soot deposition is, the shorter the regeneration time (20 to 60 minutes) becomes, so fuel consumption is improved. To improve work efficiency, execute DPF manual regeneration during work breaks (lunch hour or before/after the start of the work day).
- To execute DPF manual regeneration, the engine coolant temperature is required to be "40 deg. C" or above. For the engine speed, the engine controls its speed to the optimum level similar to the automatic regeneration.
 - Engine speed setting by the engine speed control dial on the control panel is ignored.
- DPF manual regeneration lamp (⚠) may stay lit even if the DPF soot deposition meter reads below "80%". This is because DPF regeneration is not executed completely (DPF soot deposition meter reads "0%"). Continue DPF regeneration without interruptions until DPF soot deposition meter reads "0%".
- While you can manually interrupt DPF regeneration under way, once you start DPF regeneration, it is recommended to continue DPF regeneration until DPF soot deposition meter (1) reads "0%".

(1) How to execute DPF manual regeneration

When DPF manual regeneration lamp (☸) (6) on the monitor display lights up, execute DPF manual regeneration according to the following procedure.

1. Move the machine to a safe and flat place, and park it there.
2. Check that DPF soot deposition meter (1) reads "80%" or above.
3. Start the engine and continue warming-up operation until engine water temperature gauge (2) reads "40 deg. C" or above.
4. Continue pressing DPF manual regeneration switch (3) for "3 seconds".

The engine starts DPF regeneration.

At the same time, DPF regeneration stop lamp (☸) (6) goes out.

5. When the engine starts DPF regeneration, DPF regeneration lamp (☸) (5) lights up.

★During DPF regeneration, the engine controls its speed to the optimum level. Engine speed setting by the engine speed control dial on the control panel is ignored.

6. When DPF regeneration completes, DPF regeneration lamp (☸) (5) goes out and DPF soot deposition meter (1) reads "0%".

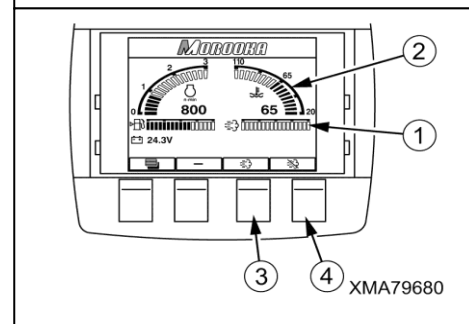
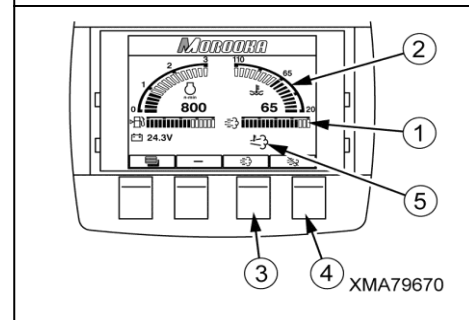
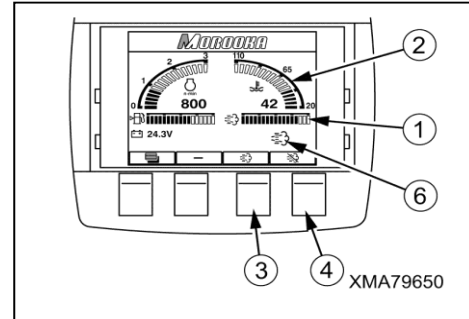

(2) How to interrupt or stop DPF manual regeneration

When you are required to stop DPF regeneration forcibly in an emergency, continue pressing DPF regeneration stop switch (4) for "3 seconds". The engine stops DPF regeneration.

At the same time, DPF regeneration lamp (☸) (5) goes out and DPF regeneration stop lamp (☸) (7) lights up.

★Use this switch to stop DPF regeneration urgently in cases where the engine suddenly starts DPF regeneration during operations and poses a problem for the work or people other than authorized persons enter the work site during DPF regeneration.

★To restart DPF regeneration, continue pressing DPF manual regeneration switch (3) for "3 seconds". The engine restarts DPF regeneration. At the same time, DPF regeneration stop lamp (☸) (7) goes out.

★To stop DPF regeneration, turn the starting switch to "OFF" position to stop the engine.

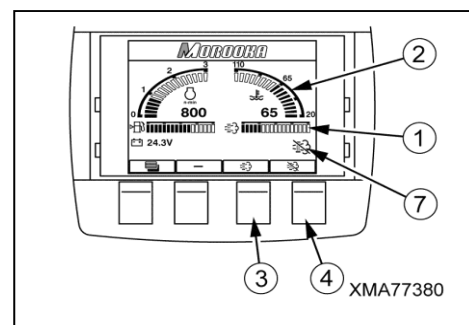



3.3 OPERATIONS AND CHECKS BEFORE STARTING ENGINE

1. Check following items before getting on the machine.

(1) Check that the dump body completely lowered.

(2) Check that upper revolving structure (1) faces the front side of undercarriage structure (2).

★The figure on the right shows the machine with upper revolving structure (1) and undercarriage structure (2) facing in the same direction. Since sprocket (A) of undercarriage structure (2) is located forward when viewed from the operator's seat, the operating direction of the travel lever and pedal matches forward/reverse direction and turning directions (left turn and right turn) of the machine.

★The figure on the right shows the machine with upper revolving structure (1) facing in the opposite direction (rear) of undercarriage structure (2). Since sprocket (A) of undercarriage structure (2) is located rearward when viewed from the operator's seat, the operating direction of the travel lever and pedal is opposite to forward/reverse direction and turning directions (left turn and right turn) of the machine.

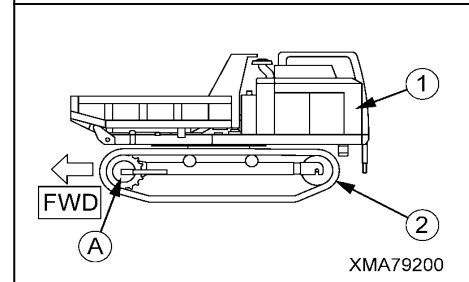
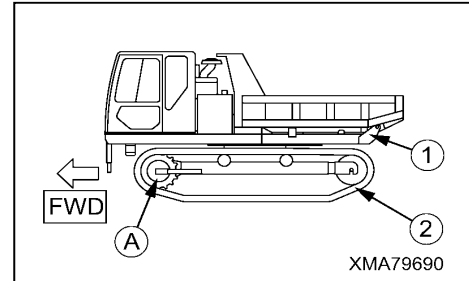

2. Check that the left and right travel levers are at the "Neutral" position.

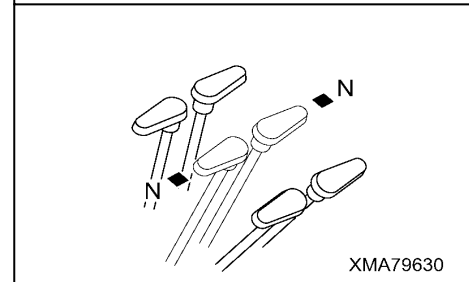

2. Check that the parking brake switch is at the ON (STOP) position.

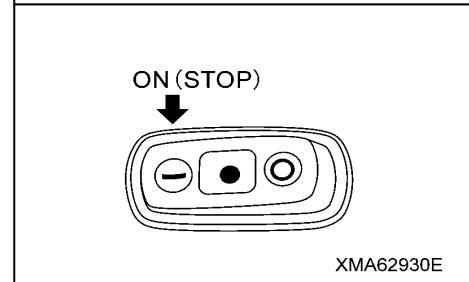

4. Check that swing lock switch on the monitor display box at the ON (LOCK) position.

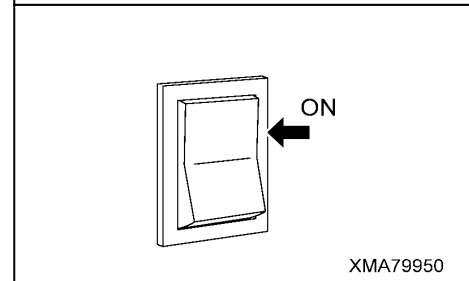

5. Check that swing and dump control lever at the HOLD position.

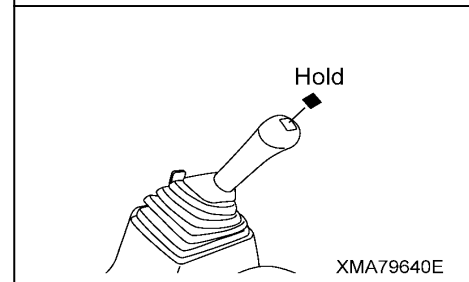

3.4 STARTING ENGINE

⚠ WARNING

Check that there are no persons or obstacles in the surrounding area, then sound the horn and start the engine.

NOTICE

- When starting the engine, be sure to press the parking brake switch to set it to the ON (STOP) position. The engine cannot be started without setting the parking brake switch to this ON (STOP) position.
- Do not try to start the engine immediately when inserting the starting switch.

Turn the switch to the ON position and wait for approx. 6 seconds. During this time, the engine warning lamp (🚫) (Orange) and engine stop lamp (🛑) (red) at the monitor display light up and then go out.

- Do not crank the starting motor continuously for more than 15 seconds.

If the engine does not start, wait for at least 2 minutes before trying to start again.

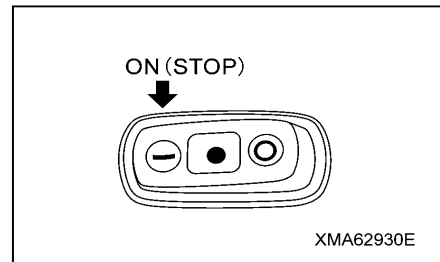

[1] STARTING ENGINE

1. Turn the engine speed control dial to the low speed position.

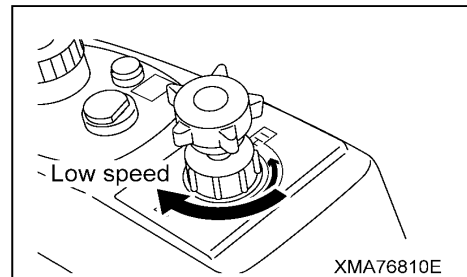

2. Insert the key in the starting switch, turn it to the ON position, and check that the engine warning lamp (🚫) (orange) and engine stop lamp (🛑) (red) at the monitor display light up.

Wait for approx. 6 seconds and check that the lamps go out.

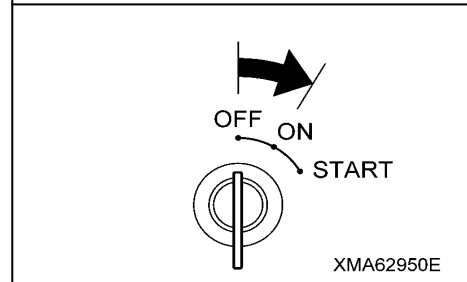

⚠ CAUTION

If the starting motor is turned on by turning the key of the starting switch to the ON position before the engine warning lamp (🚫) (orange) and the engine stop lamp (🛑) (red) at the monitor display go out, the starting motor may be damaged and fail.



3. Start the engine by turning the key of the starting switch to the START position and activating the starting motor.

★ In cold weather conditions, the intake air heater starts automatically to preheat the intake air according to the condition of the intake air temperature and coolant temperature. For this reason, the starting motor may turn over a little longer before the engine starts up.

The "glow lamp" on the monitor display box lights up when the air intake heater automatically starts to work.

Before starting the engine, check that the "glow lamp" has gone out.

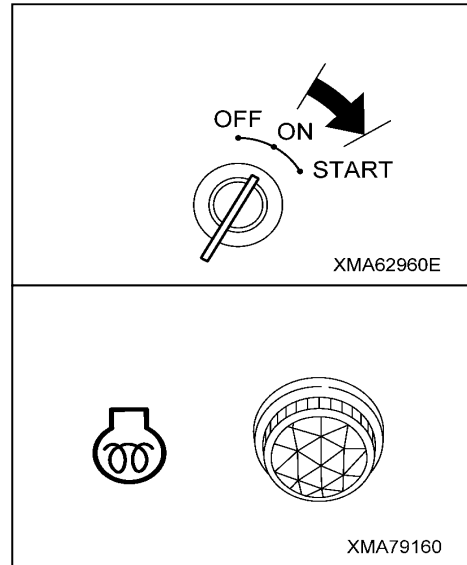

! CAUTION

When starting the engine, do not keep turning over the starting motor for more than 15 seconds at a time. If you do so, the starting motor may fail or you may drain the battery.

4. If the engine does not start on the first try, return the key of the starting switch to the OFF position, wait for approximately two minutes for the battery to recover and the starting motor to cool down, then turn the key to the ON position again (as explained in Steps 2 and 3).

! CAUTION

If you try to start the engine more times without stopping the starting motor completely, the starting motor pinion and the engine ring gears may be damaged and fail.

5. If the engine does not start even when you have tried to start it twice, there may be some problems with the battery or the engine starting circuit. Check the battery voltage, the electrical wiring of the starting motor, and other factors.

6. After the engine starts, release the key.

★ The key will return automatically to the ON position.

! CAUTION

Never turn the key of the starting switch to the START position while the engine is running. Doing so may damage the starting motor pinion, inside parts, or engine ring gears.

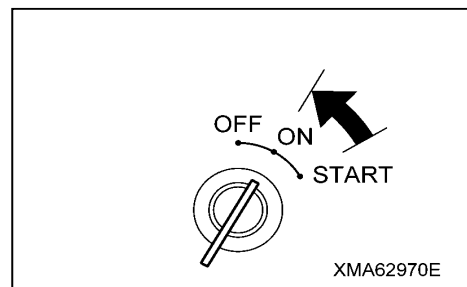



[2] AFTER STARTING (warming-up operation)

NOTICE

Run the engine under light load until the engine coolant temperature is within a range of 50°C - 80°C (122°F - 176°F). Do not suddenly accelerate the engine.

After the engine starts, carry out the warming-up operation as follows.

1. Turn the engine speed control dial to the low speed position, and run for approx. 5 minutes under no load.

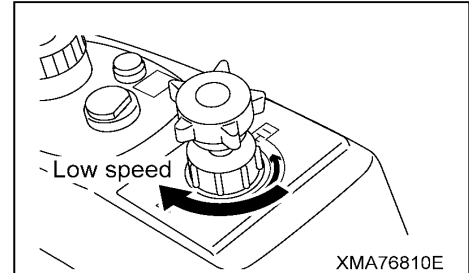

2. Turn the engine speed control dial to the mid-range speed position, and run for approx. 5 minutes under no load.

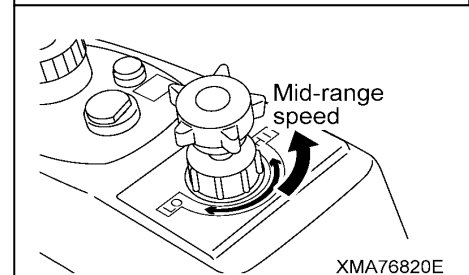

3. After being seated on the operator's seat, set safety lock lever (1) to "FREE" position.

★Safety lock bar (2) rises to impede the operator in leaving the operator's seat outside the machine.

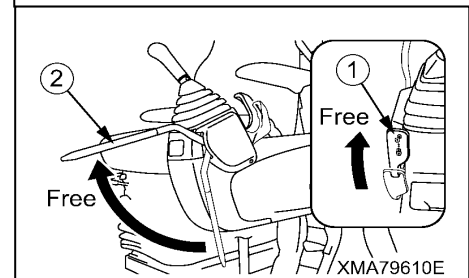

4. Operate swing and dump control lever to the RAISE position, raise the dump body to the maximum height, and run the engine in this condition for approx. 5 minutes.

★Keep swing and dump control lever at the RAISE position.

5. Keep swing and dump control lever at the RAISE position, turn the engine speed control dial to the right (clockwise) further to run the engine at high speed, and run the engine in this condition for 2 - 5 minutes.

This operation warms up the hydraulic oil and makes the operation of the travel and dump body smooth.

6. Check that the monitor display, charge lamps and parking brake buzzer work normally.

7. Check that there is no abnormality in the exhaust gas color, engine noise, or vibration.

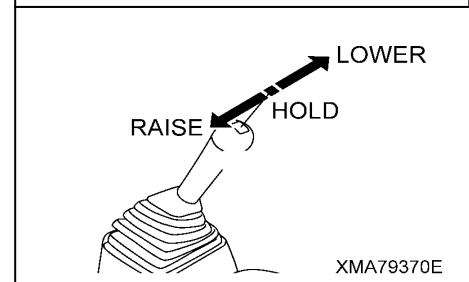



3.5 MOVING MACHINE OFF

⚠ WARNING

- Check that the swing lock pilot lamp (orange) is lighting up.
If the lamp goes out, set the swing lock switch to "ON" (LOCK) position.
When the upper revolving structure is not locked, if the machine travels on a rough ground or a slope, the upper revolving structure can move, causing an unexpected accident.
- Check whether the center pilot lamp (red) and rear swing pilot lamp (green) light up or go out.
When the center pilot lamp (red) lights up, the upper revolving structure is positioned parallel to the undercarriage structure.
When the rear swing pilot lamp (green) lights up, the upper revolving structure is positioned backward. In this case, forward and reverse operations of the lever and pedal are reversed with each other.
- Do not make travel operations using the travel pedal in the following situations. Be sure to use the travel lever.
 - Stopping the machine
 - Passing through narrow quarters
 - Traveling uphill or downhill
 - Turning (left turn and right turn)
 - Pivot turn
 When using the travel pedal, it is difficult to maintain fine control of the machine, disabling the machine to make a sure stop and turn a corner. This can cause the machine to hit other obstacles, fall, or run over others.
- Check that there is no one in the area around the machine before starting. Check particularly carefully around the dump body at the rear of the machine.
- When starting the machine off, check that the surrounding area is safe, and sound the horn to inform people that you are starting.
- When starting the machine off, operate the travel lever or pedal gradually. The more the travel lever or pedal is operated, the faster the machine will travel. Do not start the machine off suddenly.
- When starting the machine on a slope, be sure to select the low-speed range for travel speed. In addition, set the machine parallel to the slope before starting it.
- When starting uphill on slopes, always start in the low speed range and run the engine at high speed. Keep the travel lever as close as possible to the "Neutral" position.
- When the machine is traveling downhill in forward gear, if the slope angle exceeds "9 deg.", "ㄩ!" appears on the monitor display screen and the slope caution buzzer located at the rear of the operator's seat sound to issue a warning. When the slope caution buzzer is sounding, it is dangerous to start the machine with its dump body loaded. Lower the engine speed to a low speed, set the travel lever to a position close to "Neutral", and start the machine carefully.
- While keeping a close watch on the clinometer through the right cab window while traveling downhill in forward gear, take care not to allow the machine to travel with the clinometer reading "9 deg." and above. When the clinometer reads an angle close to "9 deg.", switch course to one with a gentler incline. In addition, lower the engine speed to a low speed, set the travel lever close to "Neutral" position, and operate the machine carefully.
- In case of an emergency, if it is required to stop the machine urgently, press the emergency stop switch on the monitor display box. This applies the parking brake and urgently stops the machine.

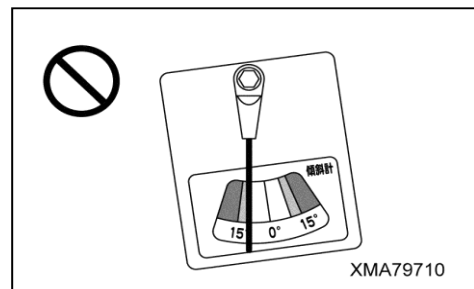

★When both rear swing pilot lamp (green) and center pilot lamp (red) light up, sprocket (A) is located backward, so operating directions for forward/reverse travel are reversed with each other.

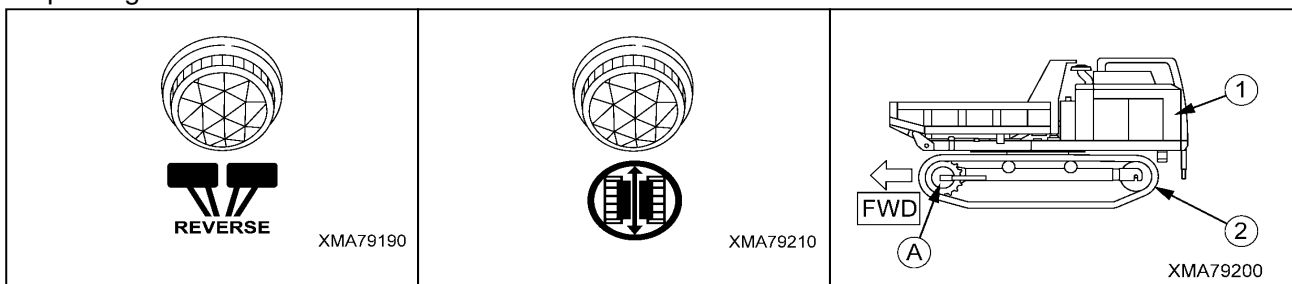

★While the travel lever or pedal is being operated, travel alarm buzzer keeps sounding.

1. Turn the engine speed control dial to the mid-range speed position.

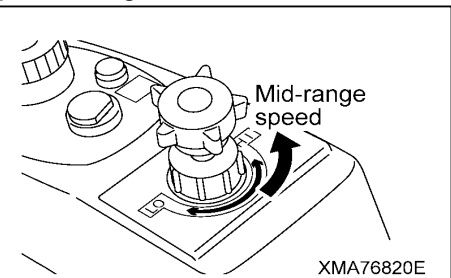

2. Check that the emergency stop switch on the monitor display box is at "NORMAL" position.

Turn the emergency stop switch clockwise to set it to "NORMAL" position.

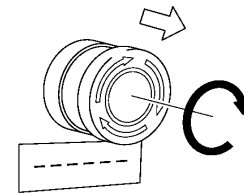

3. Press the parking brake switch on "OFF" (RUN) side to release the parking brake.

★Check that "P" on the monitor display screen goes out and the parking brake buzzer stops sounding.

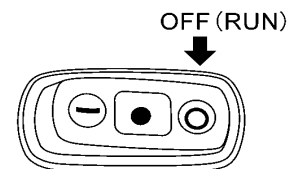

4. Move both travel levers forward gradually to start the machine slowly.
Or depress top parts of both travel pedals gradually.

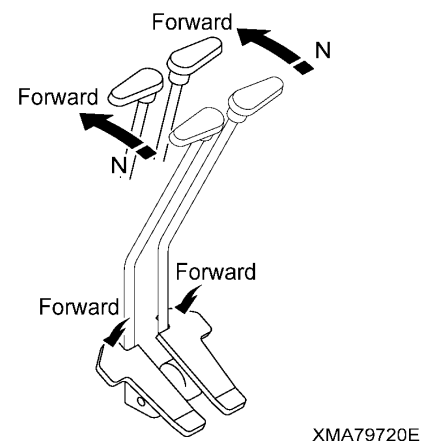

★When both rear swing pilot lamp (green) and center pilot lamp (red) light up, operate them as follows.

4. Move both travel levers backward gradually to start the machine slowly. Or depress bottom parts of both travel pedals gradually.

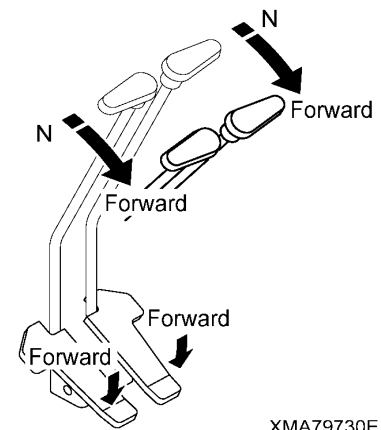

3.6 SHIFTING SPEED RANGE AND CHANGING BETWEEN FORWARD AND REVERSE

⚠ WARNING

- When traveling, select a travel speed to match the travel surface and ground condition.
- Check whether the center pilot lamp (red) and rear swing pilot lamp (green) light up or go out. When the center pilot lamp (red) lights up, the upper revolving structure is positioned parallel to the undercarriage structure. When the rear swing pilot lamp (green) lights up, the upper revolving structure is positioned backward. In this case, forward and reverse operations of the lever and pedal are reversed with each other.
- Do not make travel operations using the travel pedal in the following situations. Be sure to use the travel lever.
 - Stopping the machine
 - Passing through narrow quarters
 - Traveling uphill or downhill
 - Turning (left turn and right turn)
 - Pivot turn

When using the travel pedal, it is difficult to maintain fine control of the machine, disabling the machine to make a sure stop and turn a corner. This can cause the machine to hit other obstacles, fall, or run over others.

- When traveling on a slope, be sure to set the travel speed range to the low speed range. Also, when traveling on a slope, travel straight forward.
- When going down a slope, always travel in the low speed range. Run the engine at low speed and operate the travel lever a maximum of half way from the "Neutral" position. Traveling at excessive speed is dangerous and will cause overrunning.
- When traveling up a slope, always travel in the low speed range. Run the engine at the rated speed and keep the travel lever close to the "Neutral" position. Always travel directly up the slope.
- When the machine is traveling downhill in forward gear, if the slope angle exceeds "9 deg.", "⚠" appears on the monitor display screen and the slop caution buzzer located at the rear of the operator's seat sound to issue a warning. When the slop caution buzzer is sounding, it is dangerous to start the machine with its dump body loaded. Lower the engine speed to a low speed, set the travel lever to a position close to "Neutral", and start the machine carefully.
- While keeping a close watch on the clinometer through the right cab window while traveling downhill in forward gear, take care not to allow the machine to travel with the clinometer reading "9 deg." and above. When the clinometer reads an angle close to "9 deg.", switch course to one with a gentler incline. In addition, lower the engine speed to a low speed, set the travel lever close to "Neutral" position, and operate the machine carefully.
- When switching between FORWARD and REVERSE, always stop the machine before shifting direction.

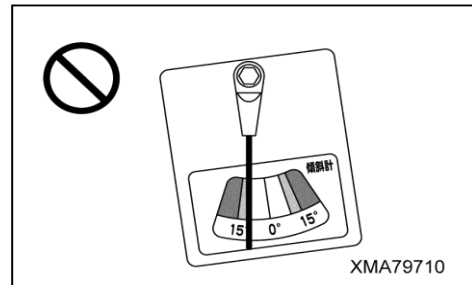

If the direction of travel is shifted suddenly between FORWARD and REVERSE, it will cause failures such as reverse rotation of the engine.

- When switching the travel speed range, always stop the machine first before operating the switch.
- In case of an emergency, if it is required to stop the machine urgently, press the emergency stop switch on the monitor display box. This applies the parking brake and urgently stops the machine.

★When both rear swing pilot lamp (green) and center pilot lamp (red) light up, sprocket (A) is located backward, so operating directions for forward/reverse travel are reversed with each other.

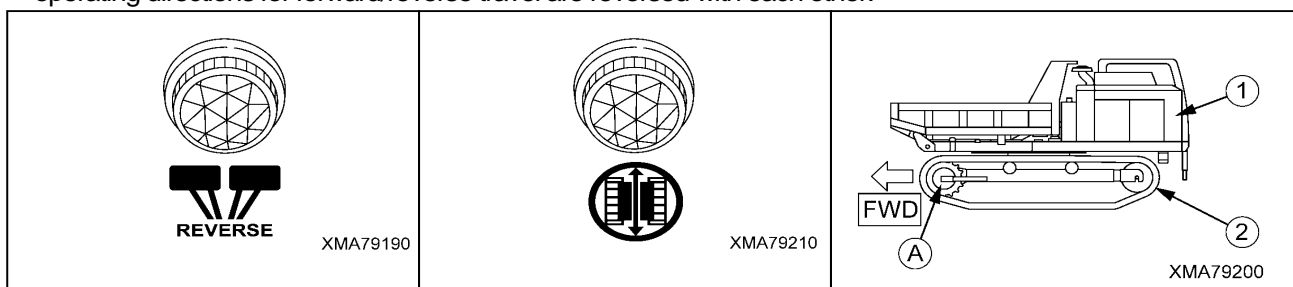



[1] CHANGING SPEED

The travel speed can be changed by changing the amount that the left and right travel levers or pedals are operated.

1. The closer the left and right travel levers or pedals are to the "Neutral" position, the lower the travel speed.
2. The further the left and right travel levers or pedals are from the "Neutral" position, the higher the travel speed.

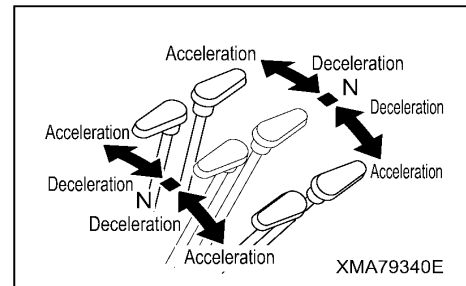

[2] SHIFTING BETWEEN FORWARD AND REVERSE

The direction of travel can be changed by changing the direction of operation of the travel levers and pedals.

- When the left and right travel levers are pushed forward, the machine will travel forward. Or depressing top parts of both travel pedals will move the machine forward.
- When the left and right travel levers are pulled back, the machine will travel in reverse. Or depressing the bottom parts of both travel levers will move the machine in reverse.

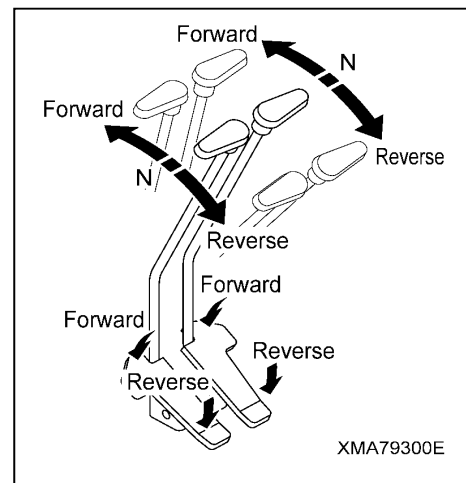

★When both rear swing pilot lamp (green) and center pilot lamp (red) light up, operate them as follows.

The direction of travel can be changed by changing the direction of operation of the travel levers and pedals.

- When the left and right travel levers are pulled back, the machine will travel forward. Or depressing the bottom parts of both travel pedals will move the machine forward.
- When the left and right travel levers are pushed forward, the machine will travel in reverse. Or depressing top parts of both travel pedals will move the machine in reverse.

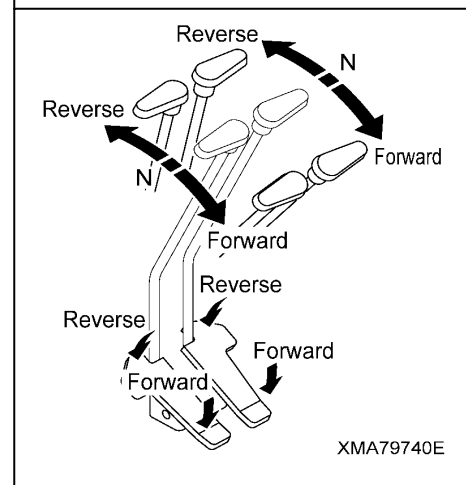

[3] SWITCHING BETWEEN HIGH AND LOW SPEED RANGES

The travel speed range is changed by operating the Hi-Lo speed range selector switch.

- When the switch is pressed, the mechanism inside the travel motor is switched and the machine changes to the high speed range. At the same time, high speed "H" appears on the monitor display screen indicating that the machine is traveling in the high speed range.
- Pressing the switch again returns the mechanism in the travel motor to the original settings and the machine travels in the low-speed range. At the same time, high speed "H" disappears from the monitor display screen indicating that the machine is traveling in the low speed range.

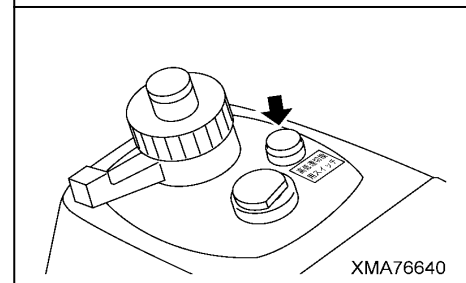

3.7 STEERING MACHINE

⚠ WARNING

- Check whether the center pilot lamp (red) and rear swing pilot lamp (green) light up or go out. When the center pilot lamp (red) lights up, the upper revolving structure is positioned parallel to the undercarriage structure. When the rear swing pilot lamp (green) lights up, the upper revolving structure is positioned backward. In this case, forward and reverse operations of the lever and pedal are reversed with each other.
 - Do not make travel operations using the travel pedal in the following situations. Be sure to use the travel lever.
 - Stopping the machine
 - Passing through narrow quarters
 - Traveling uphill or downhill
 - Turning (left turn and right turn)
 - Pivot turn
- When using the travel pedal, it is difficult to maintain fine control of the machine, disabling the machine to make a sure stop and turn a corner. This can cause the machine to hit other obstacles, fall, or run over others.
- Do not turn the machine sharply at high speed; do not carry spin turns unless necessary. This will damage the crawler and hydraulic equipment, and there is also danger that the machine may hit other objects.
 - The machine may slip to the side if it is turned on a slope, so avoid turning on slopes as far as possible. Be particularly careful about turning on soft ground of clay ground.
 - When the machine is traveling downhill in forward gear, if the slope angle exceeds "9 deg.", "⚠" appears on the monitor display screen and the slop caution buzzer located at the rear of the operator's seat sound to issue a warning. When the slop caution buzzer is sounding, it is dangerous to start the machine with its dump body loaded. Lower the engine speed to a low speed, set the travel lever to a position close to "Neutral", and start the machine carefully.
 - While keeping a close watch on the clinometer through the right cab window while traveling downhill in forward gear, take care not to allow the machine to travel with the clinometer reading "9 deg." and above. When the clinometer reads an angle close to "9 deg.", switch course to one with a gentler incline. In addition, lower the engine speed to a low speed, set the travel lever close to "Neutral" position, and operate the machine carefully.
 - In case of an emergency, if it is required to stop the machine urgently, press the emergency stop switch on the monitor display box. This applies the parking brake and urgently stops the machine.

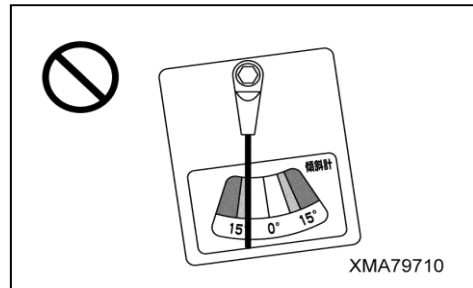

★When both rear swing pilot lamp (green) and center pilot lamp (red) light up, sprocket (A) is located backward, so operating directions for forward/reverse travel are reversed with each other.

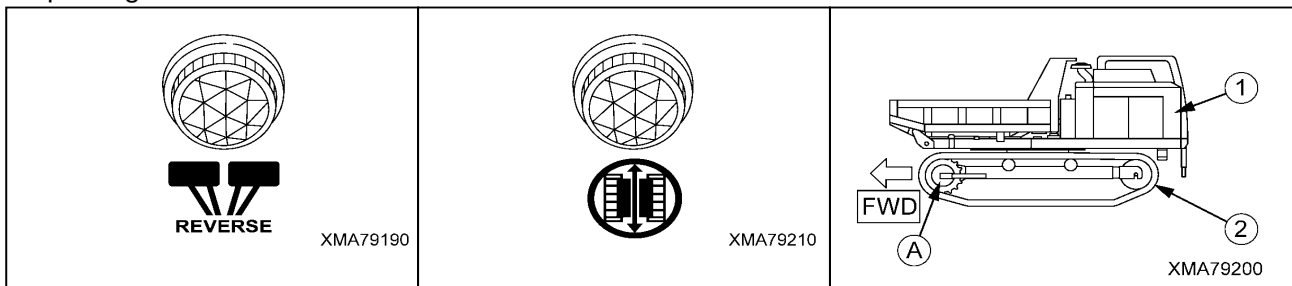

[1] GRADUAL TURN

The radius of the turn is determined by the difference in the amount that the left and right travel levers are operated. The larger the difference between the left and right travel levers, the smaller the radius of the turn will be.

[Turning while increasing speed]

(When forward travelling)

- To make a gradual turn when traveling forward, push the travel lever forward a small amount on the opposite side to the direction of the turn. To make a rapid turn when traveling forward, push the travel lever forward a large amount on the opposite side to the direction of the turn.
- When turning to the left, push the right travel lever forward. When turning to the right, push the left travel lever forward.

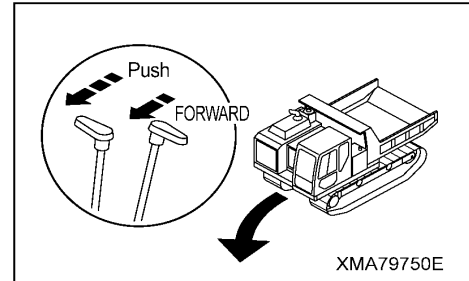

(When reverse travelling)

- To make a gradual turn when traveling in reverse, pull the travel lever back a small amount on the opposite side to the direction of the turn. To make a rapid turn when traveling in reverse, pull the travel lever back a large amount on the opposite side to the direction of the turn.
- When turning to the left, pull the right travel lever back. When turning to the right, pull the left travel lever back.

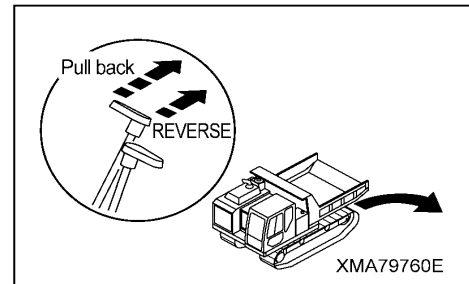

[Turning while decreasing speed]

(When forward travelling)

- To make a gradual turn when traveling forward, pull the travel lever back a small amount in the direction of STOP on the same side as the direction of the turn. To make a rapid turn when traveling forward, pull the travel lever back a large amount on the same side as the direction of the turn.
- When turning to the left, pull the left travel lever back towards STOP. When turning to the right, pull the right travel lever back towards STOP.

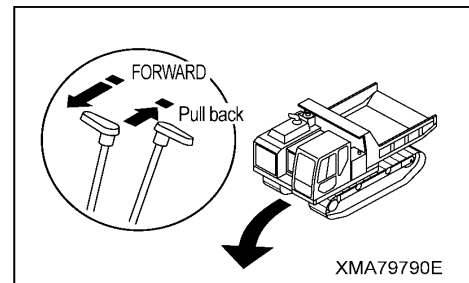

(When reverse travelling)

- To make a gradual turn when traveling in reverse, push the travel lever back a small amount in the direction of STOP on the same side as the direction of the turn. To make a rapid turn when traveling forward, push the travel lever back a large amount on the same side as the direction of the turn.
- When turning to the left, push the left travel lever back towards STOP. When turning to the right, push the right travel lever back towards STOP.

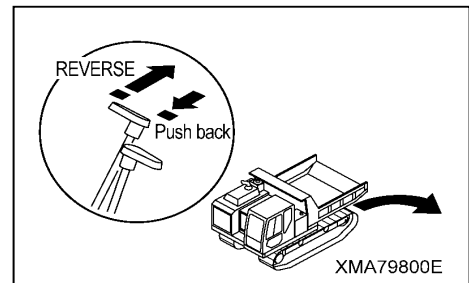



★When both rear swing pilot lamp (green) and center pilot lamp (red) light up, operate them as follows.

[1] GRADUAL TURN

The radius of the turn is determined by the difference in the amount that the left and right travel levers are operated. The larger the difference between the left and right travel levers, the smaller the radius of the turn will be.

[Turning while increasing speed]

(When forward travelling)

- To make a gradual turn when traveling forward, pull the travel lever back a small amount on the same side to the direction of the turn.
- To make a rapid turn when traveling forward, pull the travel lever back a large amount on the same side to the direction of the turn.
- When turning to the left, pull the left travel lever back.
- When turning to the right, pull the right travel lever back.

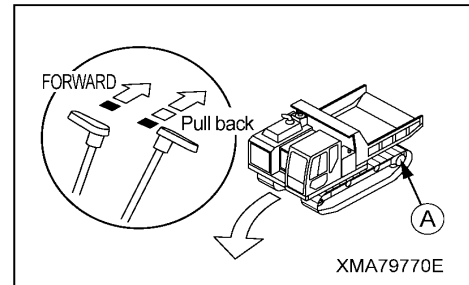

(When reverse travelling)

- To make a gradual turn when traveling in reverse, push the travel lever forward a small amount on the same side to the direction of the turn.
- To make a rapid turn when traveling in reverse, push the travel lever forward a large amount on the same side to the direction of the turn.
- When turning to the left, push the left travel lever forward.
- When turning to the right, push the right travel lever forward.

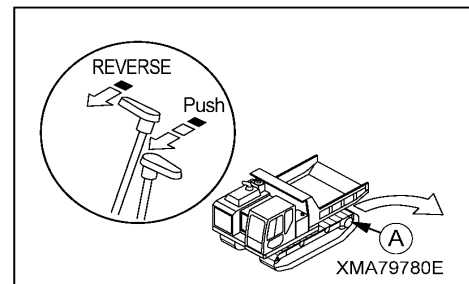

[Turning while decreasing speed]

(When forward travelling)

- To make a gradual turn when traveling forward, push the travel lever back a small amount in the direction of STOP on the opposite side as the direction of the turn.
- To make a rapid turn when traveling forward, push the travel lever a large amount on the opposite side as the direction of the turn.
- When turning to the left, push the right travel lever towards STOP.
- When turning to the right, push the left travel lever towards STOP.

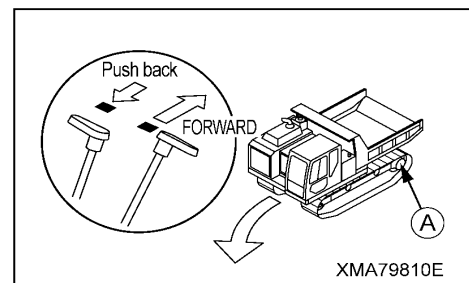

(When reverse travelling)

- To make a gradual turn when traveling in reverse, pull the travel lever back a small amount in the direction of STOP on the opposite side as the direction of the turn.
- To make a rapid turn when traveling in reverse, pull the travel lever back a large amount on the opposite side as the direction of the turn.
- When turning to the left, pull the right travel lever back towards STOP.
- When turning to the right, pull the left travel lever back towards STOP.

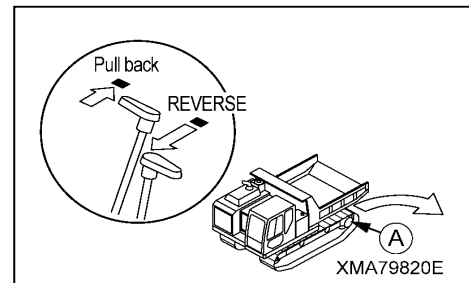



[2] PIVOT TURN

Operate the travel lever on one side and set the other lever at the "Neutral" position.

Only the crawler on the side that is operated will rotate, so the machine will make a pivot turn.

- To turn to the left when traveling forward, push the right travel lever forward.

To turn to the right when traveling forward, push the left travel lever forward.

- To turn to the left when traveling in reverse, pull the right travel lever back.

To turn to the right when traveling in reverse, pull the left travel lever back.

★When both rear swing pilot lamp (green) and center pilot lamp (red) light up, operate them as follows.

- To turn to the left when traveling forward, pull the left travel lever back.
- To turn to the right when traveling forward, pull the right travel lever back.

- To turn to the left when traveling in reverse, push the left travel lever forward.

To turn to the right when traveling in reverse, push the right travel lever forward.

[3] SPIN TURN (Counter rotation turn)

Operate the left and right travel levers in opposite directions. The left and right crawlers will rotate in opposite directions and the machine will make a spin turn.

- To turn to the left, push the right travel lever forward and pull the left travel lever back.
- To turn to the right, push the left travel lever forward and pull the left travel lever back.

★When both rear swing pilot lamp (green) and center pilot lamp (red) light up, operate them as follows.

- To turn to the left, push the left travel lever forward and pull the right travel lever back.
- To turn to the right, push the right travel lever forward and pull the left travel lever back.

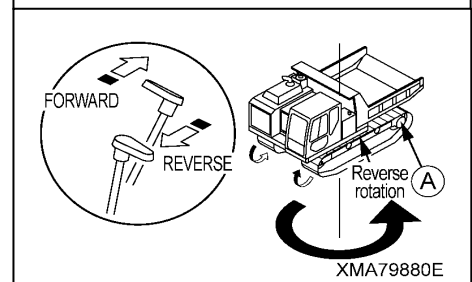
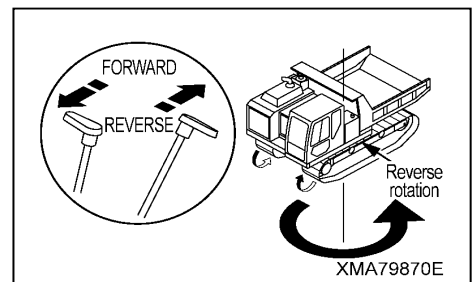
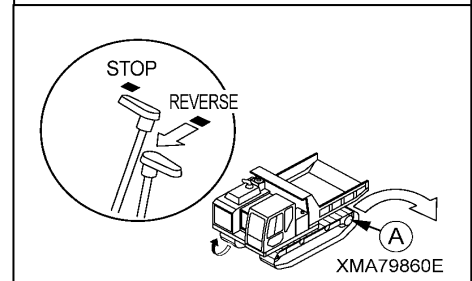
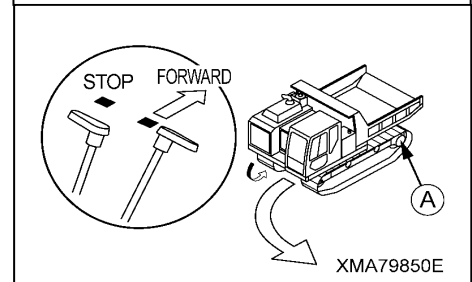
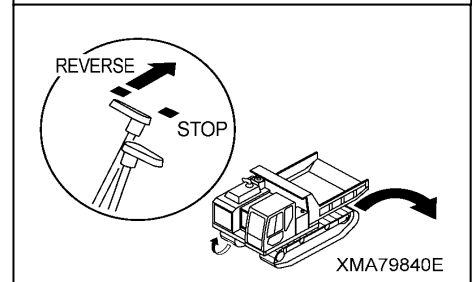
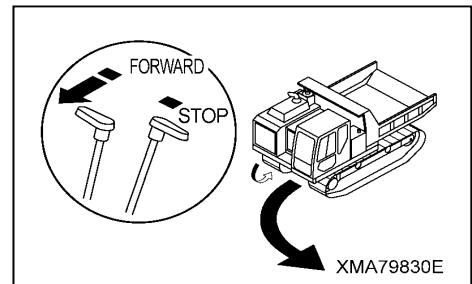



3.8 STOPPING MACHINE

⚠ WARNING

- Check whether the center pilot lamp (red) and rear swing pilot lamp (green) light up or go out. When the center pilot lamp (red) lights up, the upper revolving structure is positioned parallel to the undercarriage structure. When the rear swing pilot lamp (green) lights up, the upper revolving structure is positioned backward. In this case, forward and reverse operations of the lever and pedal are reversed with each other.
 - Do not make travel operations using the travel pedal in the following situations. Be sure to use the travel lever.
 - Stopping the machine
 - Passing through narrow quarters
 - Traveling uphill or downhill
 - Turning (left turn and right turn)
 - Pivot turn
- When using the travel pedal, it is difficult to maintain fine control of the machine, disabling the machine to make a sure stop and turn a corner. This can cause the machine to hit other obstacles, fall, or run over others.
- Avoid stopping suddenly. Always leave room to spare when stopping.
 - In case of an emergency, if it is required to stop the machine urgently, press the emergency stop switch on the monitor display box. This applies the parking brake and urgently stops the machine.
 - When stopping the machine, return the left and right travel levers at the same time to the “Neutral” position. If the left and right levers are not operated at the same time, there is danger that the brakes will pull to one side.
 - When stopping, do not return the travel lever past the “Neutral” position. If the travel lever is moved past the “Neutral” position, it will cause failures such as reverse rotation of the engine.

Return the left and right travel levers to the “Neutral” position.

The hydraulic brake is automatically applied and the machine will stop.

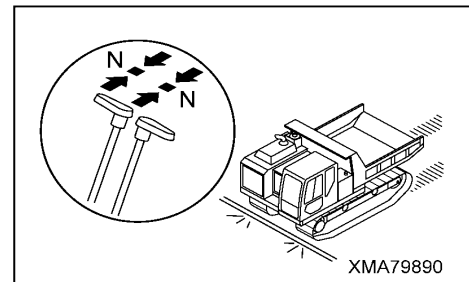



3.9 EMERGENCY STOPPING MACHINE

⚠ WARNING

If a dangerous state occurs by any possibility, and when it becomes necessary to stop the machine urgently, press the parking brake switch to set it to the ON (STOP) position or turn the engine starting switch to the OFF position to stop the engine.

To stop the machine in an emergency, take either of following procedures to stop the engine. The parking brake applies automatically when the engine is stopped.

- Push in the emergency stop switch on the monitor display box surface to stop the machine.
- Turn the engine starting switch to the OFF position to stop the engine.

NOTICE

If you have used the emergency stop switch during traveling, be sure to contact your distributor and ask for inspection of the parking brake. Once the emergency switch is used, the parking brake in performance degrades.

There are following 2 methods when making an emergency stop of the machine.

- Press the emergency stop switch on the monitor display box. The parking brake applies and the machine stops.

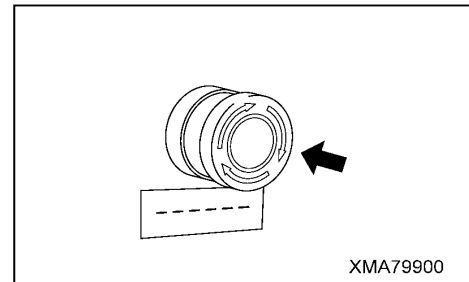

- Turn back the starting switch key to the OFF position to stop the engine.

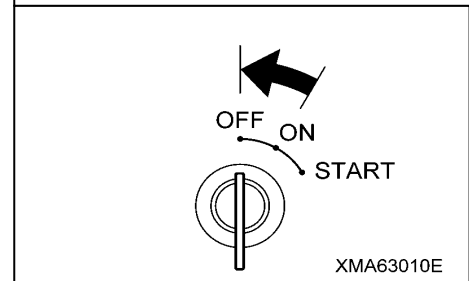



3. 10 SWINGING UPPER REVOLVING STRUCTURE

⚠ WARNING

- Before performing swing operations of the upper revolving structure, be sure to stop the machine in a flat place. If performing swing operations on a slope, the swing speed can increase when the upper revolving structure moves downward from a high place, causing an unexpected accident.
- If there are many other persons or obstacles around the machine, enlist a guide who can ensure the safety of the surrounding area and make swing operations according to his/her instructions.
- Be slow to operate the swing and dump control lever. Swinging the loaded upper revolving structure at high speeds or stopping it suddenly can cause machine troubles and endangers the safety of surrounding area as well.
- Before leaving the operator's seat, be sure to stop the engine and set the safety lock lever to "LOCK" position.

Execute swing operations of the upper revolving structure according to the following procedures.

1. Turn the engine speed control dial to the mid-range speed position.

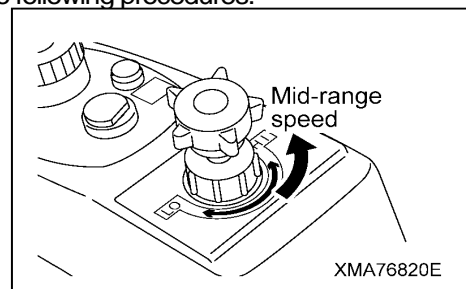

2. Press the parking brake switch on "ON" (PARK) side to apply the parking brake.

★Check that "P" on the monitor display screen lights up and the parking brake buzzer sounds.

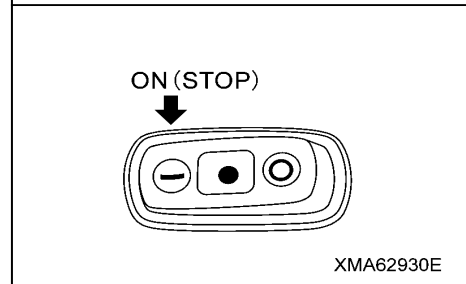

3. Set the swing lock switch on the monitor display box to "OFF" (FREE) position.

★The swing lock lamp goes out to indicate that swing operations are enabled.

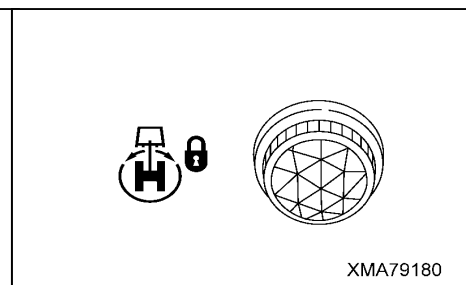
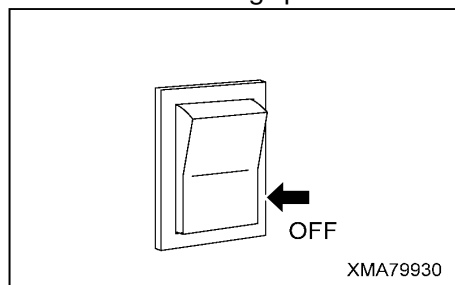

4. Operate the swing and dump control lever slowly to the left or right.

- Swing left: The upper revolving structure swings to the left (counterclockwise).
- Hold: The upper revolving structure stops on the spot and stays there.
- Swing right: The upper revolving structure swings to the right (clockwise).

★If you release your hold, the control lever automatically returns to "Hold" position.

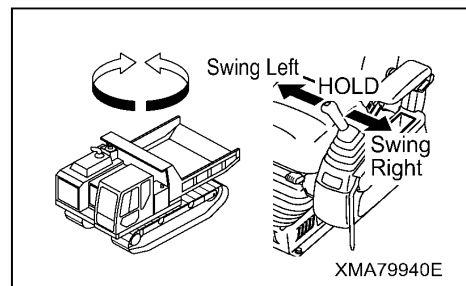

★ Starting swing operations lights up the yellow revolving warning lamp (1) at the top of the machine front to issue a warning that the upper revolving structure is swinging.

★ When the upper revolving structure is positioned in the opposite direction to the undercarriage structure (swung exceeding 90 deg. backward), the rear swing pilot lamp lights up. After that, if the machine continues to swing further, the rear swing pilot lamp stays lit. When the upper revolving structure is positioned in the same direction as the undercarriage structure (swung exceeding 90 deg. forward), the rear swing pilot lamp goes out.

★ The figure on the right shows the range in which the swung upper structure is regarded as positioned in opposite direction to the undercarriage exceeding 90 deg. backward. While the upper structure is swinging within the swing range indicated by arrows, the rear swing pilot lamp stays lit. If the upper revolving structure exits this range and is positioned facing forward, the rear swing pilot lamp goes out.

★ When the upper revolving structure is positioned facing the front or rear (backward) of the undercarriage structure, the center pilot lamp lights up.

★ The figure on the right shows the machine with upper revolving structure (1) facing in the opposite direction (rear) of undercarriage structure (2). In this condition, both rear swing pilot lamp (green) and center pilot lamp (red) light up. Since sprocket (A) of undercarriage structure (2) is located rearward when viewed from the operator's seat, the operating direction of the travel lever and pedal is opposite to forward/reverse direction and turning directions (left turn and right turn) of the machine.

Example:

If the travel lever or pedal is operated forward, the machine moves in reverse when viewed from the operator's seat.

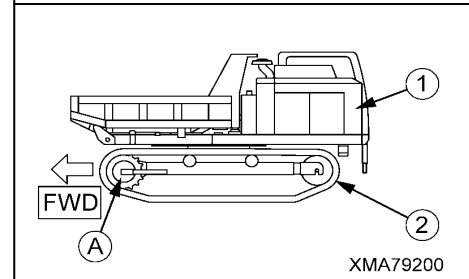
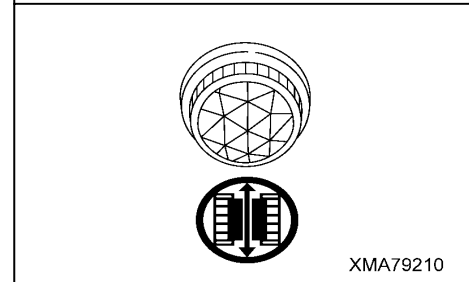
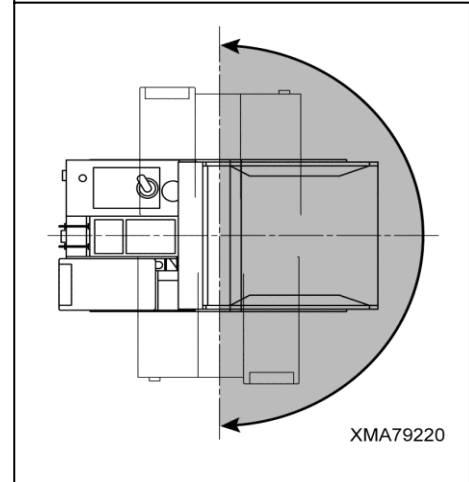
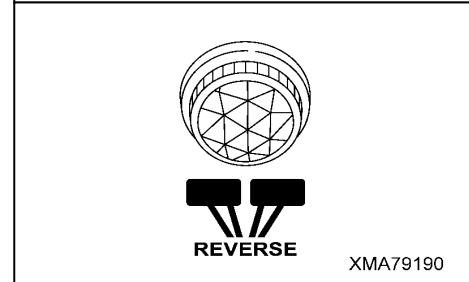
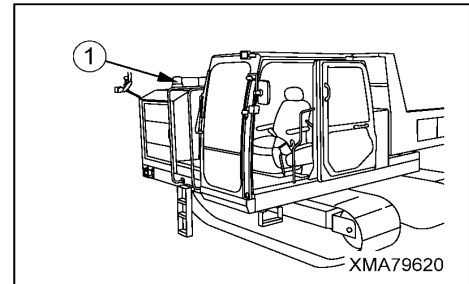

★The figure on the right shows the machine with upper revolving structure (1) and undercarriage structure (2) facing in the same direction. In this condition, only center pilot lamp (red) light up. Since sprocket (A) of undercarriage structure (2) is located forward when viewed from the operator's seat, the operating direction of the travel lever and pedal matches forward/reverse direction and turning directions (left turn and right turn) of the machine.

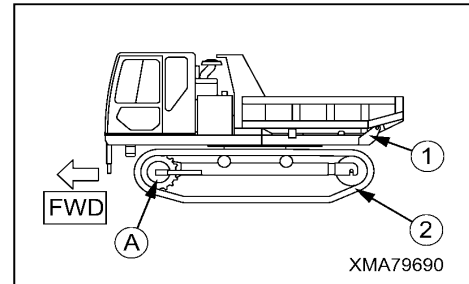

6. After completing swing operations, set the swing lock switch on the monitor display box to "ON" (LOCK) position.

★The swing lock lamp lights up to indicate that the swing operation is disabled.

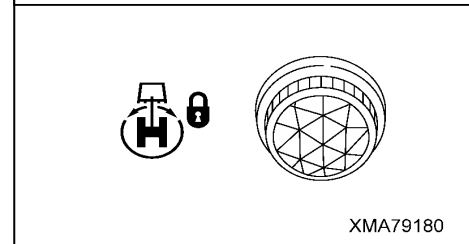
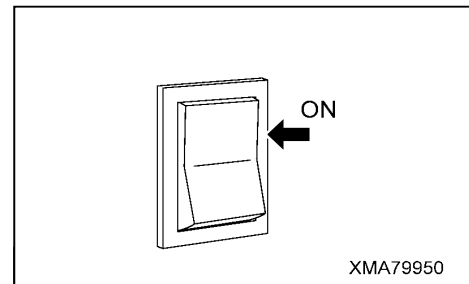

3.11 PARKING MACHINE

⚠ WARNING

Choose firm, level ground to park the machine.

If the machine must be parked on the slope, apply the parking brake and block the tracks to prevent the machine from moving.

Set the parking brake switch to the ON (STOP) position to apply the parking brake.

★ Check that "P" lights up on the monitor display screen and the parking brake buzzer sounds.

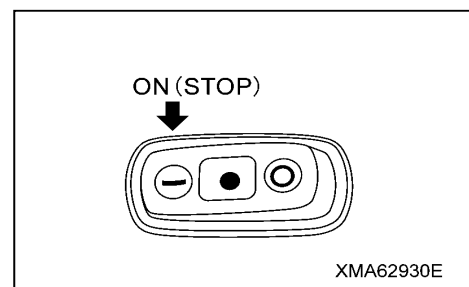

3.12 STOPPING ENGINE

NOTICE

- Do not stop the engine before it has properly cooled down. Stopping the machine before it cools down will shorten the service life of the engine. Never stop the engine suddenly except in emergency.
- If the engine has overheated, do not stop it suddenly. Run the engine at a mid-range speed and gradually cool it down before stopping the engine.

1. Turn the engine speed control dial to the low speed position to reduce the engine speed and run the engine at idling for 5 minutes to cool the engine down.

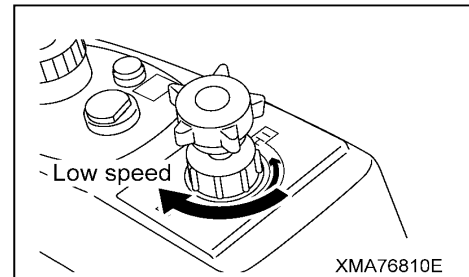

2. Return the key in the starting switch to the OFF position.

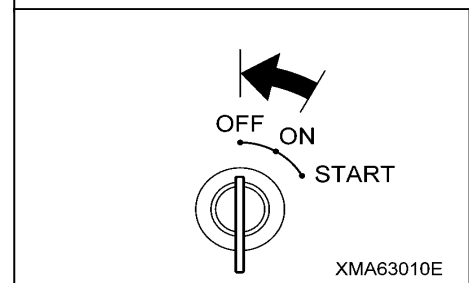

3.13 LEAVING CAB

When leaving the cab after the workday, observe the followings.

1. Before leaving the operator's seat, be sure to set safety lock lever (1) to "LOCK" position.
2. Safety lock bar (2) lowers allowing the operator to leave the operator's seat to go outside the machine.
3. Be sure to bring the starting switch with you.

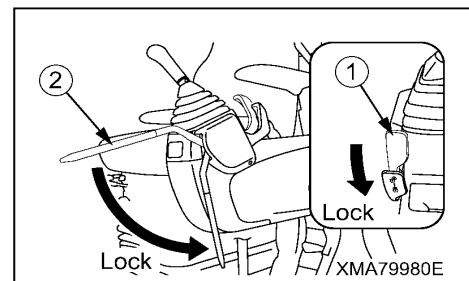

3.14 CHECKS AFTER STOPPING ENGINE

- Carry out a walk-around check and check the undercarriage, dump body, and bodywork; check also for leakage of oil and water. If any abnormality is found, repair it.
- Fill the fuel tank with fuel.
- Remove any dead leaves, waste paper, or other flammable materials from around the engine that may cause fire.
- Remove any mud or snow stuck to the undercarriage or dump body.



3.15 LOCKING

To prevent vandalism, the following locations can be locked.

- (1) Cab door
- (2) Cab air conditioner filter inspection cover
- (3) Fuel tank filler cap

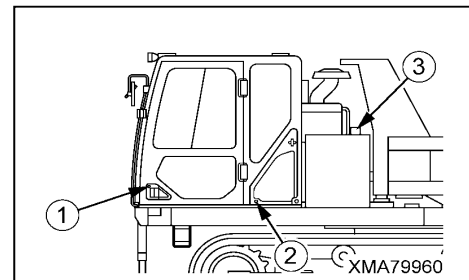

- (4) Inspection cover at right side of chassis

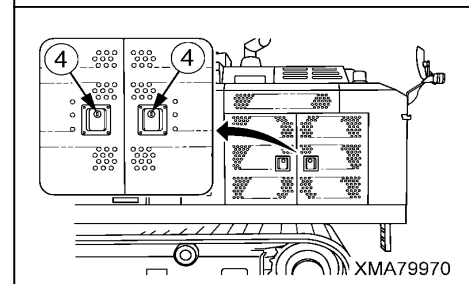

3.16 PRECAUTIONS WHEN TRAVELING

⚠ WARNING

Always follow these precautions when traveling. Failure to follow these precautions may lead to a serious injury or accident.

[1] PERMISSIBLE WATER DEPTH

When operating in water, do not let the bottom surface of the track frame go below the water surface.

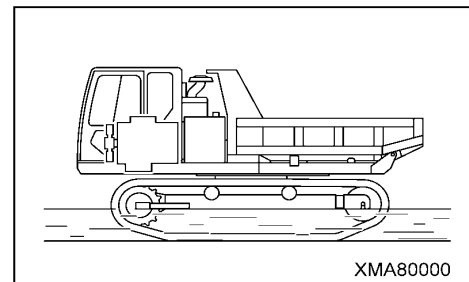

[2] USE OF EMERGENCY STOP SWITCH AND PARKING BRAKE SWITCH

When stopping the machine, return the travel lever to the "Neutral" position. The hydraulic brake inside the HST is automatically applied to stop the machine. Never use the parking brake to stop the machine.

Usually, do not use the emergency stop switch or parking brake switch to stop the machine.

Doing so brakes the machine suddenly and causes failure of the travel motors as well. Except when an emergency stop is needed, do not use the emergency stop switch or parking brake switch to stop the machine.

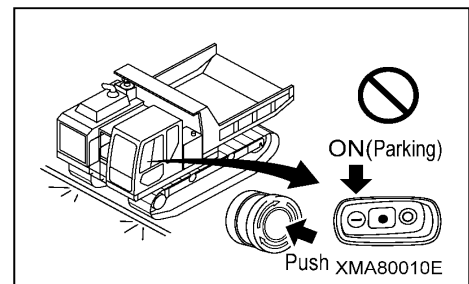

[3] PAY ATTENTION TO ANGLE ALARM BUZZER

When the machine is traveling downhill in forward gear, if the inclination of the slope becomes "9 deg." or above, "Z!" lights up on the monitor display screen and slope caution buzzer at the rear of the operator's seat sounds to issue a warning. When the slope caution buzzer is sounding, it is dangerous to drive the machine with the dump body being loaded. Lower the engine speed to low speeds, move the travel lever to a position close to "Neutral", and carefully drive the machine.

★Do not use the travel pedal on a slope.

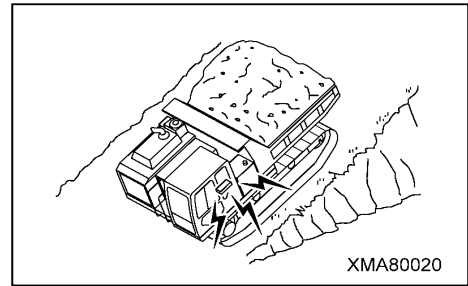

[4] PRECAUTIONS WHEN ENGINE STOPS ON SLOPES

If the engine stops on a slope, do as follows.

1. Return the travel lever to the "Neutral" position.
2. Press the parking brake switch to the ON (STOP) position.

★Check that the parking brake lamp lights up.

3. Start the engine again.

★Do not use the travel pedal on a slope.

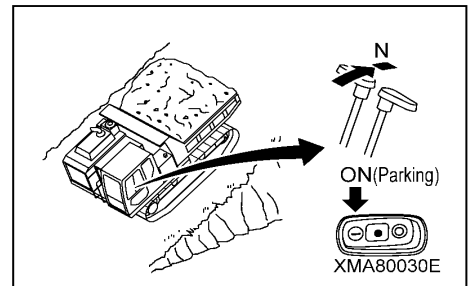

[5] PRECAUTIONS WITH FUEL LEVEL ON SLOPES

If the fuel level in the fuel tank is low and the machine is on a slope or there is swaying, the engine may suck in air, which may cause the engine to stop.

Always maintain a sufficient level of fuel in the fuel tank.

[6] PRECAUTIONS FOR OIL LEVELS ON SLOPES

When traveling or carrying out operations on steep slopes, check the oil level in the hydraulic tank and engine, and add oil to the high level.

This will prevent failure caused by lack of oil.

[7] KEEP A CLOSE WATCH ON REAR SWING PILOT LAMP

When the rear swing pilot lamp lights up, the upper revolving structure is positioned backward. In this case, operating directions for forward/reverse travel are reversed with each other.

After each swing operation, be sure to check whether the rear swing pilot lamp lights up.

Also, be sure to check whether the center pilot lamp lights up after each swing operation. If the center pilot lamp goes out, the upper revolving structure is not positioned parallel to the undercarriage structure.

If they are not parallel to each other, travel deviation becomes large even if you are driving the machine with the intention of traveling straight.

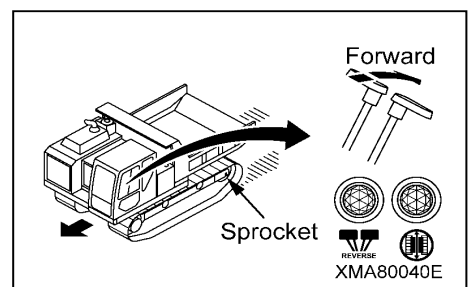

4. HANDLING DUMP BODY

4.1 OPERATING DUMP BODY

⚠ WARNING

- Always stop the machine before operating the dump body to the dump position.
- Position a signalman to ensure safety in the surrounding area, and follow his signals when carrying out the dumping operation.
- Always operate the dump control lever slowly. If the dump body is suddenly stopped or it is allowed to hit the frame when it is lowered, it will cause failures and will also cause problems of safety in the surrounding area.
- When leaving the operator's compartment with the dump body raised, always lock the dump control lever.

In addition, use the safety bar to prevent the dump body from coming down. Even when the engine is stopped, it is possible to lower the dump body.

Operate the dump body as follows.

- ★The further the swing and dump control lever is operated, the faster the dump body will move.
 - ★When the swing and dump control lever is released, it automatically returns to the HOLD position.
1. Stop the machine completely. For details, see "3.7 STOPPING MACHINE".
 2. Turn the engine speed control dial to the high speed position and raise the engine speed sufficiently.

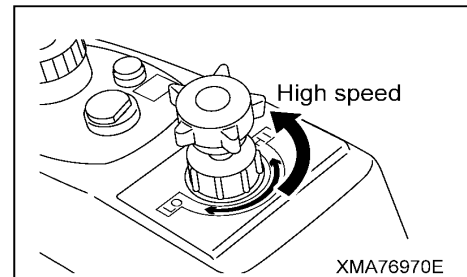

3. Pull the swing and dump control lever up.

The dump body will rise.

- ★When the dump body comes near to the max. height, push the swing and dump control lever down to reduce the speed of the dump body.

4. Push the dump control lever (1) down.

The dump body will go down.

- ★When the dump body comes near to the frame, pull the swing and dump control lever up to reduce the speed of the dump body.

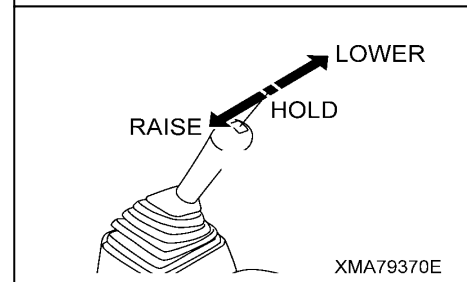

4.2 OPERATING SAFETY BAR

⚠ WARNING

- If it is necessary to go under the dump body to carry out inspection and maintenance, always use the safety bar to prevent the dump body from coming down.
- When using the safety bar, check that the bar is fitted securely to the dump body holder.
- The safety bar is a safety device used during inspection and maintenance. Do not use the safety bar to support the dump body when replacing the dump cylinder, valve, hydraulic hoses, or other equipment. In such cases always support the dump body with a crane.

NOTICE

- The safety bar is provided at 2 places: at both sides of the rear of the machine. Be sure to set both bars.
- When setting the safety bar in position, never start the engine and operate the swing and dump control lever to the LOWER position. If this is done, the safety bar will hit the dump body and may break.

[1] INSTALLING SAFETY BAR

1. Raise the dump body to at least upper (60 deg.). For details, see “4.1 OPERATING DUMP BODY”.
2. Raise safety bar (1) and set it in holder (2) in the bottom surface of the dump body.
3. Stop the engine. The dump body will go down under its own weight.
 - ★ If the dump body does not go down under its own weight, start the engine and operate the dump control lever to lower it to a point where the dump body and safety bar still do not come into contact.

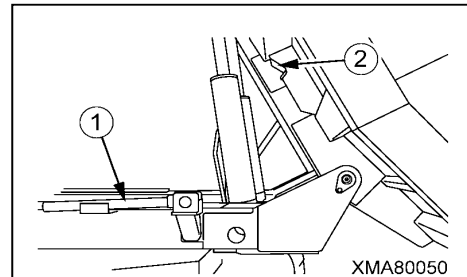

[2] REMOVING SAFETY BAR

1. Raise the dump body fully. For details, see “4.1 OPERATING DUMP BODY”.
2. Return safety bar (1) to the fixed position on top of the frame.

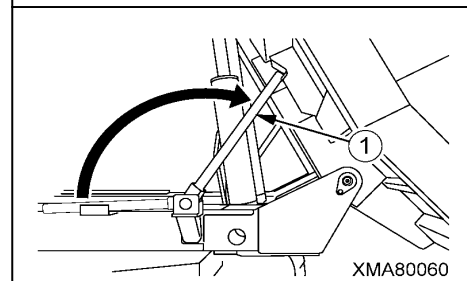



4.3 PRECAUTIONS DURING OPERATION

⚠ WARNING

**Always follow these precautions when carrying out operations.
Failure to follow these precautions may lead to a serious injury or accident.**

[1] PRECAUTIONS FOR JOBSITES

- As far as possible, select firm, level ground.

When working on slopes or extremely uneven ground, the change in the center of gravity when the dump is operated may cause the machine tip over.

- As far as possible, avoid the edge of cliffs or ground which may collapse.

If work must be carried out in such places, set up blocks to prevent the machine from going near the edge or near retaining walls, or position a signalman and take other necessary steps for ensuring safety.

- When dumping a load from a high point, always position a signalman and follow the signals.

The signalman must always check the safety of the dumping point carefully.

- When performing dumping operations with the upper revolving structure being swung, in addition to precautions for normal dumping operation, pay special attentions to the following.

- After dumping operations with the upper revolving structure set in reverse direction, the travel directions of the machine are reversed.

Take care not to mistake the operating directions of the travel lever. Mistaking them can cause a fall or collision.

- If it is requested to perform unloading work with the upper revolving structure being swung 90 deg., check the conditions of unloading area and ensure there is enough distance between the machine and unloading area or road shoulders. And, be sure to swing the upper revolving structure after the machine arrives at unloading area, and after the unloading, lower the dump body and swing the upper revolving structure to the original position, and then move the machine.
- Performing dump operations on a slope with the upper revolving structure being swung 90 deg. increases the danger of rollover. Stop the operation if you sense any danger in machine stability.

[2] PRECAUTIONS FOR LOAD

- Do not overload the machine.

Do not fit side racks or plates, or make other modifications to extend the size of the dump body to increase the load.

- When loading the dump body, always spread the load uniformly.

Loading the dump body unevenly will cause instability and may cause the machine to tip over.

- Be careful not to let the loading bucket or crane hook hit the dump body or flaps.

- When loading large rocks, first load the dump body with fine soil, then load the rocks on top of that.

- When handling long objects, such as logs or steel beams, load carefully and pay careful consideration to the center of gravity so that the load does not collapse or sway excessively during hauling operations.

Tie down such loads securely with rope.

If necessary, use blocks and take steps to prevent the rope from slipping.

- When loading stacks of U-shaped ditch liners or concrete blocks, lay a steel sheet and secure with rope, and take other steps to prevent the load from slipping.

5. HANDLING RUBBER CRAWLER

5.1 FEATURES OF RUBBER CRAWLER

The properties of the material used for the rubber crawlers gives it many advantages, such as low vibration, high drawbar pull, and ease of handling.

Make sure that you fully understand the advantages of rubber crawlers, and follow the content of “5.2 PROHIBITED OPERATIONS FOR RUBBER CRAWLER” and “5.3 PRECAUTIONS WHEN USING RUBBER CRAWLER” to extend the service life of the rubber crawlers and to realize the maximum advantages of the rubber crawler.

5.2 PROHIBITED OPERATIONS FOR RUBBER CRAWLER

- Turning operations or other operations on hard rocky ground, extremely rough rocky, in places with many tree stumps, on steel rods or steel scrap, or places with many sharp objects, or on concrete surfaces will cause damage to the rubber shoe.
- On riverbeds or other jobsites where there are large numbers of rocks of different sizes, the rocks will get caught in the rubber shoe and damage the shoe or cause it to come off the roller.
- Do not let oil, fuel, or chemical solvent get on the rubber shoe.
Do not travel in places where there is oil on the road surface.
- Do not let the machine enter any place where the ground is at high temperature, such as on asphalt or steel plates that have been left in the sun or in places where there have been fires.
- When putting the machine in long-term storage (3 months or more), store the machine indoors where it is out of direct sunlight and rain.

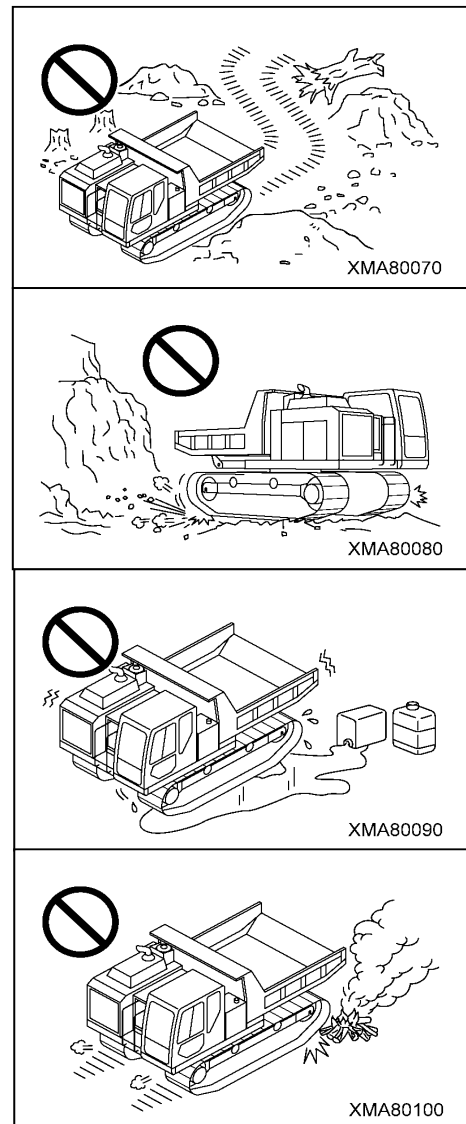

5.3 PRECAUTIONS WHEN USING RUBBER CRAWLER

⚠ WARNING

Always follow these precautions when using rubber crawlers. Failure to follow these precautions may lead to a serious injury or accident.

- Do not make sharp turns on concrete surfaces.
- Do not operate the machine in such a way that the rubber track scrapes against concrete walls.
- Sudden changes of direction will cause damage and premature wear to the rubber shoes, so avoid sudden turns as far as possible.
- Avoid traveling and turning in places where there is a large ridge. When traveling over a ridge, approach the ridge at a right angle.
- As far as possible, avoid handling loads that produce oil when crushed (soy beans, corn, vegetables, etc.). If the machine is used for handling such products, be sure to wash the track thoroughly after use.
- When handling loads such as salt, ammonium sulphate, potassium chloride, potassium sulphate, or phosphates, be sure to wash the track thoroughly after use.
- On snow or frozen road surfaces, the rubber shoe will slip very easily. Be careful also of slipping when traveling or operating on slopes.
- To prevent the rubber shoe from coming off, always check that the tension is correct.
If the tension is too loose, the rubber shoe will come off and there will be abnormal wear of the steel core and sprocket.
If the tension is too tight, the travel speed will be reduced and there will be premature wear or damage to the undercarriage.

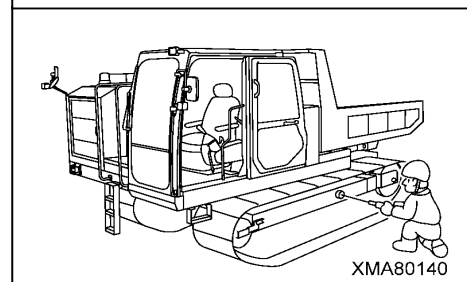
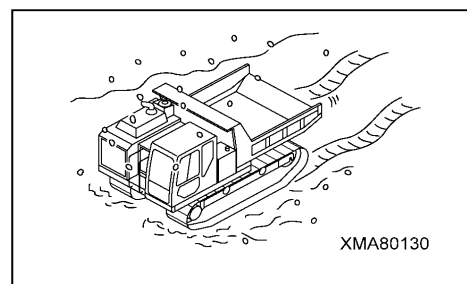
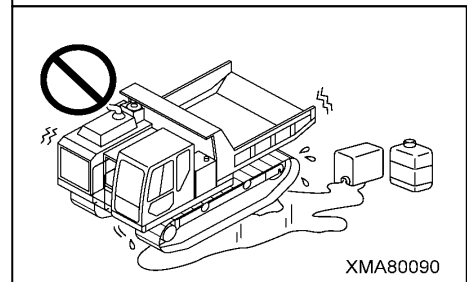
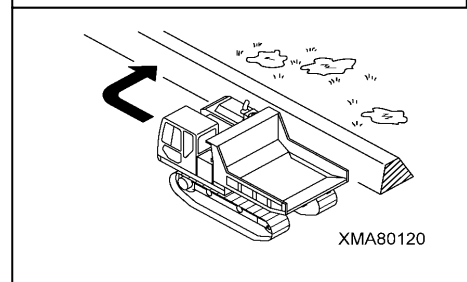
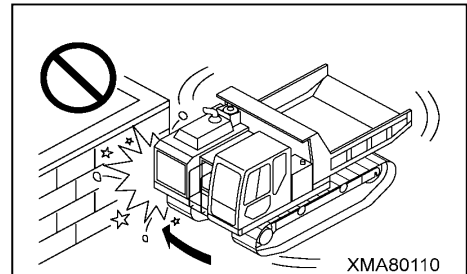

6. TRANSPORTATION

6.1 LOADING, UNLOADING WORK

⚠ WARNING

- Make sure the ramp has sufficient width, length and thickness to enable the machine to be safely loaded and unloaded. If the ramp sags appreciably, reinforce it with blocks, etc.
- When loading and unloading the machine, park the trailer on a flat firm roadbed. Keep a fairly long distance between the road shoulder and the machine.
- Remove the mud from the undercarriage to prevent the machine from slipping to the side on slopes. Be sure the ramp surface is clean and free of grease, oil, ice and loosen materials.
- Never change the direction of travel when on the ramps. If it is necessary to change direction, drive off the ramps and correct the direction, then drive on to the ramps again.

When loading or unloading, always use ramps or a platform and carry out the operations as follows.

1. Apply the brake securely to the trailer and put blocks under the tires to prevent the machine from moving.
2. Set the ramps so that the center of the machine is aligned with the trailer, and fix securely in position.
 - ★Check that the left and right ramps are at the same height.
3. Align the machine with the ramps, and drive up or down the ramps slowly to the load or unload the machine.
4. To prevent the machine from moving during transportation, put wooden blocks under the front and rear of the rubber crawler and secure the machine with chains or wire rope.
 - Be particularly careful to secure it so that it cannot slip to the side.
 - ★This machine is equipped with fixing hooks on the track frame.

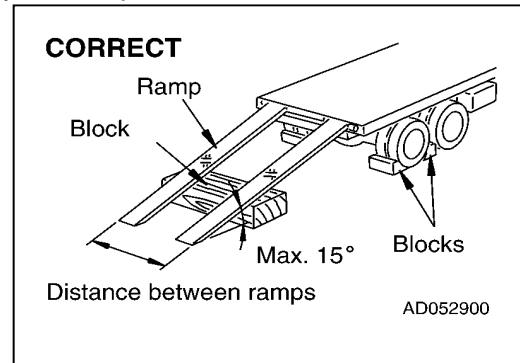

6.2 PRECAUTIONS FOR LOADING

⚠ WARNING

When loading and unloading the machine, park the trailer on a flat firm roadbed. Keep a fairly long distance between the road shoulder and the machine.

After loading the specified position, secure the machine as follows.

1. Lower the dump body slowly.
2. Push the parking brake switch in to apply the parking brake.
3. Return the engine throttle lever to the low-speed position, turn the starting switch to the OFF position and stop the engine. Remove the starting key.
4. Store the side mirrors and side camera (optional).

6.3 PRECAUTIONS FOR TRANSPORTATION

⚠ WARNING

Determine the route for transporting the machine by taking into account the width, height and weight of the machine.

Obey all state and local laws governing the weight, width and length of a load. Observe all regulations governing wide loads.



7. COLD WEATHER OPERATION

7.1 PRECAUTIONS FOR LOW TEMPERATURE

If the temperature becomes low, it becomes difficult to start the engine, and the coolant may freeze, so do as follows.

[1] FUEL AND LUBRICANTS

Change to fuel and oil with low viscosity for all components.

For details of the specified viscosity, see "MAINTENANCE 3. USE OF FUEL, COOLANT AND LUBRICANTS ACCORDING TO AMBIENT TEMPERATURE".

[2] COOLANT MIXTURE RATIO IN COOLING WATER

⚠ WARNING

The coolant is flammable, so never put it close to a fire.

NOTICE

Never use coolant with methanol, ethanol, or propanol bases.

To enable the coolant to prevent overheating, and rust, corrosion, and freezing of the cooling system, be sure to use mixture of long-life coolant and tap water as the coolant.

The coolant has rust prevention, corrosion proof, and antifreeze functions, so it can be used throughout the year.

Strictly observe the coolant mixing rate of 50 % to allow it to maintain rust prevention and anti-corrosion effects.

At factory shipment, this machine contains coolant with the following long-life coolant at a mixing rate of 50 %.

★Bear Brand coolant [Green]: Non-amine type (Long life coolant)



[3] BATTERY

⚠ DANGER

- **To avoid gas explosions, do not bring fire or sparks near the battery.**
- **Battery electrolyte is dangerous. If it gets in your eyes or on your skin, wash it off with large amounts of water, and consult a doctor.**

When the ambient temperature drops, the capacity of the battery will also drop. If the battery charge ratio is low, the battery electrolyte may freeze. Maintain the battery charge as close as possible to 100%, and insulate it against cold temperature so that the machine can be started easily the next morning.

Measure the specific gravity and calculate the rate of charge from the following conversion table.

Rated of charge (%)	Temp. of battery electrolyte				
	°C	20	0	-10	-20
	°F	68	32	14	-4
100		1.28	1.29	1.30	1.31
90		1.26	1.27	1.28	1.29
80		1.24	1.25	1.26	1.27
75		1.23	1.24	1.25	1.26

7.2 AFTER COMPLETION OF WORK

To prevent mud, water, or the undercarriage from freezing and making it impossible for the machine to move on the following morning, always observe the following precautions.

- Mud and water on the machine body should be completely removed. This is to prevent damage to the seal caused by mud or dirt getting inside the seal with frozen drops of water.
- Park the machine on concrete or hard ground. If this is impossible, park the machine on wooden boards.
- Open the drain valve and drain any water collected in the fuel system to prevent it from freezing.
- As the battery capacity drops markedly in low temperatures, cover the battery or remove it from the machine, keep it in a warm place, and install it again the next morning.
- If electrolyte level is found low, add distilled water in the morning before beginning work. Do not add the water after day's work so as to prevent fluid in the battery from freezing in the night.

7.3 AFTER COLD WEATHER

When season changes and the weather becomes warmer, do as follows.

- Replace the fuel and oil for all parts with oil of the viscosity specified.
For details, see "MAINTENACE 3. USE OF FUEL, COOLANT AND LUBRICANTS ACCORDING TO AMBIENT TEMPERATURE".
- If for any reason permanent antifreeze cannot be used, and an ethyl glycol base antifreeze (winter, one season type) is used instead, or if no antifreeze is used, drain the cooling system completely, then clean out the inside of the cooling system thoroughly, and fill with fresh water.



8. LONG-TERM STORAGE

8.1 BEFORE STORAGE

When putting the machine in storage for more than one month, do as follows.

- After every part is washed and dried, the machine shall be housed in a dry building. Never leave it outdoors. In case it is indispensable to leave it outdoors, park the machine on the flat ground and cover it with canvas etc.
- Completely fill the fuel tank, lubricate and change the oil before storage.
- Apply a thin coat of grease to metal surface of the hydraulic piston rods and the idler adjusting rods.
- Disconnect the negative terminals of the battery and cover it, or remove it from the machine and store it separately.
- If the temperature will go below 0°C (32°F), add anti-freeze to the cooling water.

When not using anti-freeze, drain all the cooling water, and put a "No coolant" sign in the operator's compartment.

8.2 PRECAUTIONS DURING STORAGE

⚠ WARNING

If warming-up operation must be carried out inside a building, open the windows and doors to ensure good ventilation and prevent gas poisoning.

- When the machine is in long-term storage, start the engine once a month and carry out the warming-up operation thoroughly. In addition, move the machine for a short distance, and carry out the raise and lower operation thoroughly for the dump body.
- ★ If the cooling water has been drained from the machine, always fill with cooling water before starting the engine.
- ★ Before operating the dump body, wipe off the coat of grease from the piston rods of the hydraulic cylinders.

8.3 PRECAUTIONS AFTER STORAGE

Carry out the following procedure when using the machine after long-term storage.

- After removing the coolant from the machine, be sure to refill with coolant.
- Wipe off the coat of grease from the piston rods of the hydraulic cylinders.
- Remove the drain plugs from the hydraulic tank, fuel tank, engine oil pan, and travel motors, and drain the water.
- Drain the water from the engine oil filter, fuel filter, and hydraulic line filter.
- Carry out the checks before starting and warm up the machine thoroughly, then check all parts of the machine carefully.

9. HANDLING BATTERY

When handling batteries, always do as follows.

⚠ DANGER

- Before working with the battery, stop the engine and turn the key in the starting switch to the OFF position.
- When working with the battery, always wear safety glasses.
- Batteries generate hydrogen gas, so there is danger of explosion. Do not smoke, use a lighter, or create any spark near the battery.
- Battery electrolyte contains sulphuric acid. If you get acid on yourself, immediately flush the area with large amounts of water. If acid gets into your eyes, flush them immediately with large amounts of fresh water, then go to a doctor for treatment.
- When removing the battery, first disconnect the negative (-) terminal of the cable from the ground. When installing, install the positive (+) terminal first.
- If a tool touches the cable connecting the positive terminal and the chassis, there is danger that it will cause sparks. Do not carry tools in your breast pocket.
- Defective contact caused by loose battery terminals can generate sparks and lead to an explosion. Tighten the battery terminals securely.

When removing, disconnect the cable from the ground terminal first.

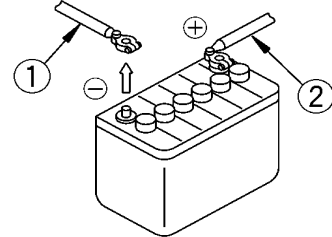

When installing, install the positive + terminal first.

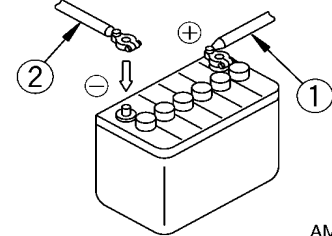

AM087770

9.1 PRECAUTIONS WHEN HANDLING BATTERY

- Always be careful not to let the battery become discharged.

Do not wait for the battery to become discharged before recharging it; measure the specific gravity of the battery electrolyte beforehand and charge the battery if necessary.

Always keeping the battery in good condition will extend the life of the battery.

- When operating the machine in high temperatures, check the level of the battery electrolyte at shorter intervals than specified for periodic inspection and maintenance.
- When working in low temperatures, the capacity of the battery will drop considerably, so maintain the battery charge as close as possible to 100%, and insulate it against cold temperatures so that the machine can be started easily the next morning.

When adding distilled water, to prevent the electrolyte from freezing, always add the distilled water immediately before starting operations on the following morning.



9.2 REMOVAL AND INSTALLATION OF BATTERY

The battery is installed into the battery box in front of the machine.

[1] REMOVAL

1. Open the inspection cover. For details, see "2.19 BATTERY INSPECTION COVER".
2. Remove locknuts (1) (left and right: x2), then remove bracket (2).
3. Disconnect the battery cable from negative (-) terminal (4) for the ground, then disconnect at positive (+) terminal end (5) and cable (6) connecting the batteries.
4. Remove 2 batteries (3).

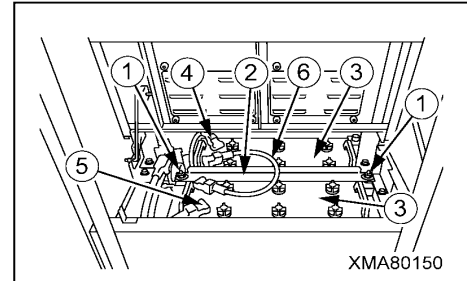

[2] INSTALLATION

Install the batteries in the reverse order to removal.

- ★When connecting the battery cables, always install the negative (-) terminal at the ground end last.

9.3 PRECAUTIONS WHEN CHARGING BATTERY

If the battery becomes discharged or the battery charge is low, charge the battery.

To charge the battery when it is still mounted on the machine, do as follows.

! WARNING

It is dangerous if the temperature of the battery electrolyte exceeds 45°C (113°F) during charging, so stop charging and wait for the temperature to go down.

- Disconnect the wiring from the battery terminals before charging.
There is danger of abnormal voltage being applied to the alternator and damaging it.
When disconnecting the wiring, always disconnect the negative (-) terminal wiring first; and when connecting the wiring, always connect the negative (-) terminal wiring last.
- During charging, remove all the plugs from the battery cells to allow any gas to escape.
- When the charging is completed, stop the charging immediately.
If the battery is overcharged, overheating of the battery will cause damage to the battery.

★Reference: Measure the specific gravity and calculate the rate of charge from the following conversion table.

Rated of charge (%)	Temp. of battery electrolyte				
	°C	20	0	-10	-20
	°F	68	32	14	-4
100		1.28	1.29	1.30	1.31
90		1.26	1.27	1.28	1.29
80		1.24	1.25	1.26	1.27
75		1.23	1.24	1.25	1.26

9.4 STARTING ENGINE WITH BOOSTER CABLE

If the battery is discharged and booster cables are used to start the engine, do as follows

⚠ DANGER

- Be careful not to let the normal machine and problem machine contact each other.
- When connecting the cables, never let the positive (+) and negative (-) terminals contact each other.
- Make sure that there is no mistake in the booster cable connection.

When the final connection is made to the negative (-) terminal, sparks will be generated, so do not connect to the negative (-) terminal of the battery on the problem machine. Connect to the engine block.

- When starting the engine with a booster cable, always wear safety glasses.

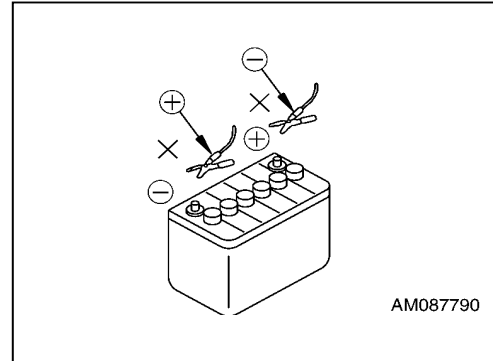

NOTICE

- The size of the booster cable and clip should be suitable for the battery capacity. Check that they are not corroded or damaged.
- The battery on the normal machine must be the same capacity as that on the problem machine.

[1] CONNECTING THE BOOSTER CABLES

★ The numbers in the diagram on the right show the order for connecting the cables.

1. Make sure that the starting switches of the normal machine and problem machine are both at the OFF position.
2. Connect the clips at the ends of booster cable **A** to the positive (+) terminal of the problem machine and the normal machine.
3. Connect one clip of booster cable **B** to the negative (-) terminal of the normal machine.
4. Connect the other clip of booster cable **B** to the engine block of the problem machine.
5. Start the problem machine.

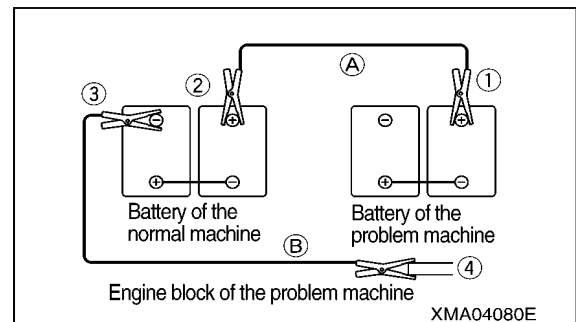

[2] DISCONNECTING THE BOOSTER CABLE

★ The numbers in the diagram on the right show the order for connecting the cables.

When the engine on the problem machine starts, remove the cables in the reverse order to connecting.

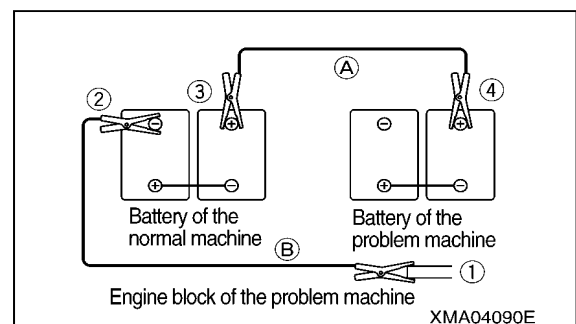



10. TROUBLESHOOTING

If it is felt that there is any abnormality, investigate the cause immediately and take the necessary action to prevent any serious failure.

If the cause is unknown, please contact your distributor for repairs.

When contacting your distributor, please give the machine serial number and engine number.

10.1 PROBLEMS WITH ENGINE RELATED PARTS

Problem	Main causes	Remedy
Starting motor does not turn when starting switch is turned to START	<ul style="list-style-type: none"> • Insufficient battery charge • Defective wiring • Failure in starting motor, relay 	<ul style="list-style-type: none"> • Charge • Check, repair • Contact your distributor
Starting motor turns, but cranks engine slowly	<ul style="list-style-type: none"> • Insufficient battery charge • Defective ground connection wiring • Viscosity of engine oil is too high 	<ul style="list-style-type: none"> • Charge • Check, repair • Change to proper viscosity
Starting motor turns, but engine does not start	<ul style="list-style-type: none"> • Lack of fuel • Air in fuel line • Failure in fuel injection pump • Failure in engine 	<ul style="list-style-type: none"> • Check, add fuel • Bleed air • Contact your distributor • Contact your distributor
Engine water temperature gauge points to around 120°C (250°F), or steam spurts out from near radiator system	<ul style="list-style-type: none"> • Lack of coolant • Leakage of oil from coolant system • Loose fan belt • Clogged radiator fin • Defective thermostat • Overloading, operation under excessive load 	<ul style="list-style-type: none"> • Check, add water • Check, repair or ccontact your distributor • Check, adjust, or replace new belt • Check, clean • Replace new parts • Reduce to below max. payload
Engine water temperature gauge indicator does not reach around 80°C (180°F)	<ul style="list-style-type: none"> • Defective thermostat • Defective engine water temperature gauge 	<ul style="list-style-type: none"> • Replace new parts • Replace new parts
Engine exhaust color is white	<ul style="list-style-type: none"> • Engine oil level is too high • Improper fuel 	<ul style="list-style-type: none"> • Adjust to correct amount • Change to specified fuel
Engine exhaust color is too black	<ul style="list-style-type: none"> • Clogged air cleaner • Improper fuel • Failure in engine 	<ul style="list-style-type: none"> • Check, clean • Change to specified fuel • Contact your distributor
Engine does not run smoothly	<ul style="list-style-type: none"> • Air in fuel line • Fuel filter clogged with dirt, water in fuel filter • Leakage of fuel from fuel system • Failure in engine 	<ul style="list-style-type: none"> • Bleed air • Check, replace new parts, or repair • Check, repair • Contact your distributor
Engine stops when set to low speed	<ul style="list-style-type: none"> • Failure in engine 	<ul style="list-style-type: none"> • Contact your distributor
Engine suddenly stops during operation	<ul style="list-style-type: none"> • Lack of fuel • Lack of engine oil • Failure in engine 	<ul style="list-style-type: none"> • Check, add fuel • Check, add oil • Contact your distributor



10.2 PROBLEMS WITH CHASSIS RELATED PARTS

Problem	Main causes	Remedy
Machine does not move	<ul style="list-style-type: none"> • Parking brake still applied • Leakage of oil from hydraulic system • Defective travel lever linkage • Failure in hydraulic equipment 	<ul style="list-style-type: none"> • Release parking brake, or check brake piping • Check, repair • Check, repair • Contact your distributor
During operation, "hydraulic oil pressure warning lamp" on the monitor display lights up, red warning lamps on both sides of the monitor display flash, and the warning buzzer sounds. (Hydraulic oil pressure lowers.)	<ul style="list-style-type: none"> • Lack oil amount in hydraulic tank • Clogged hydraulic line filter • Clogged strainer inside hydraulic tank • Defective wiring • Failure in hydraulic equipment 	<ul style="list-style-type: none"> • Check, refill • Check, clean • Check, clean • Check, repair • Contact your distributor
During operation, "hydraulic oil temperature warning lamp" on the monitor display lights up, red warning lamps on both sides of the monitor display flash, and the warning buzzer sounds. (Hydraulic oil temperature exceeds 100 deg. C.)	<ul style="list-style-type: none"> • Lack oil amount in hydraulic tank • Clogged oil cooler core • Defective function of oil cooler electric fan motor • Disconnect breaker • Defective wiring • Failure in hydraulic equipment 	<ul style="list-style-type: none"> • Check, refill • Check, clean • Check, repair • Put back • Check, repair • Contact your distributor
Abnormal noise generated from around pump	<ul style="list-style-type: none"> • Clogged strainer inside hydraulic tank • Leakage of oil from hydraulic system • Failure in hydraulic equipment 	<ul style="list-style-type: none"> • Check, clean, or replace new parts • Check, repair • Contact your distributor
Rubber crawler comes off	<ul style="list-style-type: none"> • Rubber crawler tension too loose 	<ul style="list-style-type: none"> • Check, adjust
Abnormal wear of sprocket	<ul style="list-style-type: none"> • Rubber crawler tension too tight 	<ul style="list-style-type: none"> • Check, adjust



10.3 PROBLEMS WITH ELECTRIC RELATED PARTS

Problem	Main causes	Remedy
During operation, the charge lamp on the monitor display box lights up. (Battery is not charging)	<ul style="list-style-type: none"> • Defective wiring • Loose fan belt • Defective alternator • Defective battery function 	<ul style="list-style-type: none"> • Check, repair • Check, adjust or replace • Contact your distributor • Check, repair or replace
Head lamp is not bright	<ul style="list-style-type: none"> • Battery charge is too low • Defective alternator 	<ul style="list-style-type: none"> • Charge • Contact your distributor
No lamps light up	<ul style="list-style-type: none"> • Blown fuse • Defective wiring • Defective lamp switch 	<ul style="list-style-type: none"> • Check, replace • Check, repair • Check, replace
Individual head lamps, gauge lamps do not light up	<ul style="list-style-type: none"> • Blown bulb • Defective wiring 	<ul style="list-style-type: none"> • Replace • Check, repair
Horn does not sound	<ul style="list-style-type: none"> • Blown fuse • Defective wiring • Defective horn • Defective horn switch 	<ul style="list-style-type: none"> • Check, replace • Check, repair • Check, repair • Check, replace
Left, right turn signal lamps do not flash	<ul style="list-style-type: none"> • Blown fuse • Defective wiring • Defective flasher relay • Defective flasher switch 	<ul style="list-style-type: none"> • Check, replace • Check, repair • Check, replace • Check, replace
Parking brake buzzer does not sound	<ul style="list-style-type: none"> • Blown fuse • Defective wiring • Defective buzzer • Defective parking brake switch 	<ul style="list-style-type: none"> • Check, replace • Check, repair • Check, replace • Check, replace
Travel alarm buzzer does not sound	<ul style="list-style-type: none"> • Blown fuse • Defective wiring • Defective buzzer • Defective pick-up switch 	<ul style="list-style-type: none"> • Check, replace • Check, repair • Check, replace • Check, adjust or replace
During operation, slop caution lamp on the monitor display lights up but the slope caution buzzer does not sound.	<ul style="list-style-type: none"> • Blown fuse • Defective wiring • Defective buzzer • Defective slope alarm unit 	<ul style="list-style-type: none"> • Check, replace • Check, replace • Contact your distributor • Contact your distributor



MAINTENANCE

1. Basic outline of maintenance	3-2
2. Precautions for maintenance	3-4
3. Use of fuel and lubricants according to ambient temperature	3-6
4. Tools and tightening torques	3-8
5. Periodic replacement of critical parts	3-10
6. Maintenance schedule chart	3-12
7. Service procedure	3-14



1. BASIC OUTLINE OF MAINTENANCE

[1] OIL

- Oil is used under extremely heavy-duty conditions (high temperature, high pressure) in the engine, hydraulic pump, motor, and work equipment. Therefore, it deteriorates as time passes.

Always use the grade of oil and the oil which matches the ambient temperature listed in this operation manual.

Even if the oil is not dirty, always change it at the specified interval.

- When adding oil, do not mix oils of different grades or brands.
- Always add oil to the specified oil level. Too much oil and too little oil are both the cause of problems.
- When changing the oil, always replace the related oil filter at the same time.
- Always be careful when handling oil to prevent water, dirty, or other impurities from getting into the oil.

A large proportion of problems with the machine are caused by impurities getting into the oil, so be extremely careful not to let impurities get into the oil: always store the oil indoors and carry out oil-filling operations in a dust-free environment.

- If the oil is a milky white, there is probably water or air in the circuit. In such cases, please contact your distributor.

[2] FUEL

- This machine is equipped with the regeneration type DPF. Use low sulfur light oil (light oil with sulfur content of 15 ppm or below) as fuel.
- Do not use any fuel except diesel oil.
- Always use the fuel specified for the ambient temperature listed in this operation manual.
- The fuel pump is a precision instrument, so if fuel containing water or dirt is used, the fuel pump will stop working. Be extremely careful not to let impurities get into the fuel: always store the fuel indoors and carry out refueling operations in a dust-free environment.
- If fuel is stored in drum cans, store the drum cans on their sides so that the ports in the drum cans are in a straight line to the side. This action will prevent damp air from being sucked in.
- To prevent moisture in the air from getting into the fuel tank, always fill the tank after the completion of each day's work.
- If the machine runs out of fuel, or when the fuel filter has been replaced, it is necessary to bleed the air the circuit. Always read the separate operation manual for the engine when carrying out this operation.

[3] COOLANT

- Do not use river water, well water, or water from simple water lines as the coolant. Such kinds of water contain many impurities, such as calcium and dirt, so scale will collect inside the engine and radiator. This will cause improper heat exchange, and will lead to overheating.
- If the engine overheats, allow the engine to cool down, then add coolant.
- When using antifreeze, always follow the precautions given in the operation manual.

[4] GREASE

- Grease is used at the connecting points of the dump body or travel lever linkage to prevent gouging or noise.
- The grease nipples not listed in this manual are nipples used for overhaul, so there is no need to add grease to them. However, if any gouging or noise occurs during use, add grease.
- When adding grease, pump in grease until the old grease is completely forced out, then wipe off all the old grease. Be particularly careful to wipe off the grease at points where mud and dirt may stick and cause wear of the rotating parts.



[5] FILTERS

- Filters are used to prevent trouble caused when impurities in the oil, fuel, or air enter important equipment. When the replacement interval listed in this manual is reached, always replace or clean the filters.
However, when using this machine under heavy-duty conditions, replace the filters before the specified replacement interval has passed.
- Do not wash and reuse oil filters or fuel filters. Always replace them with new parts.
- When replacing the oil filter, check the old filter for any metal particles or pieces of rubber from the hoses.
If any rubber or metal is found, please contact your distributor. This action is important to prevent any failure before it occurs.
- When using new filters, do not remove the wrapping until immediately before using them.

[6] ELECTRICAL COMPONENTS

- It is extremely dangerous if electrical components become wet or the film covering them is broken. This may lead to electrical leakage and may cause misoperation of the machine. When washing the machine, take care not to get water onto electrical components.
- Never remove any electrical components from the machine or disassemble them.
- Always contact your distributor before installing additional electrical equipment to your machine.
- After the machine has been used near the sea or after it has been used for spreading fertilizer, wipe the electrical components carefully with a dry cloth to prevent corrosion.

[7] HYDRAULIC SYSTEM

- The hydraulic equipment is at high temperature and high pressure during operations and immediately after operations have been completed.
When carrying out inspection and maintenance of the hydraulic equipment, always do as follows.
 - (1) Stop the machine on level ground, and lower the work equipment to the ground so that there is no pressure in the hydraulic cylinder circuit.
 - (2) Always stop the engine.
 - (3) Loosen the hydraulic tank cap slowly, then remove it.
 - (4) Always wait for the temperature to go down before starting maintenance. Even when the temperature goes down, the circuits are still under internal pressure, so when removing plugs or hoses, do not stand directly in front of them, and loosen the connections slowly before removing.
- If high-pressure hoses, connections, or hydraulic equipment have been removed, always replace the O-ring.
- When replacing or cleaning the hydraulic line filter or strainer, or when replacing or repairing the hydraulic equipment or hoses, always bleed the air from the circuit after completion of the operation.



2. PRECAUTIONS FOR MAINTENANCE

⚠ WARNING

- Before carrying out inspection and maintenance, always read “2. PRECAUTIONS FOR INSPECTION AND MAINTENANCE in the SAFETY” volume and make sure that you understand the safety procedures for operations.
- Do not carry out any operation not listed in this manual for inspection and maintenance. When carrying out inspection and maintenance of the engine, always read the separate engine operation manual and make sure that you understand it.

[1] CHECK HOURMETER

- Read the hourmeter every day to check if the required interval has been reached for any maintenance item.

[2] USE GENUINE PARTS

- When replacing parts, always use the genuine parts specified in the parts list.

[3] PRECAUTIONS WHEN ADDING OR CHANGING OIL OR GREASE

- When adding or changing fuel, oil, or grease, always use the type specified by Morooka. Be sure to use the viscosity specified for the ambient temperature.
- Never mix types of oil or brands of oil from different makers.
- The oil used when the machine is shipped from the factory is as shown in the table below.

Item	Type	Brand
Engine oil pan	CJ -4/DH-2 10W-30	-
Hydraulic tank	Hydraulic oil ISO VG46	Idemitsu Kosan Super Hydro X 46
Travel motor reduction gear case	SAE90 GL-5	Shin Nihon Sekiyu Gear Lube SP 90
Swing motor reduction gear case	SAE140	Showa Shell Sekiyu EP140

[4] PRECAUTIONS WHEN WASHING OR CLEANING MACHINE

- Wash or clean the machine to make it easier to locate problem points. In particular, wash the oil filler, level gauge, and greasing plugs to prevent dirt or mud from entering when adding oil or grease.
- Cover electrical parts, such as the starting motor or alternator, with a sheet to prevent water from getting on them.
- Do not carry out high-pressure washing for the radiator or oil cooler parts.

[5] BE CAREFUL OF OIL AND COOLANT TEMPERATURE

- It is dangerous to drain the oil or coolant or replace the filters immediately after stopping the engine. Wait for the machine to cool down before carrying out such operations.
- When draining the oil, warm up the oil to a suitable temperature [approx. 20 to 40°C (68 to 104°F)] before carrying out the operation.

[6] PRECAUTIONS WHEN CHECKING OIL LEVEL, ADDING OIL

- When checking the oil level or adding oil, choose a place where there is no dust to prevent dirt from entering the oil line.
- Use clean oil and grease. Use a clean container to prevent dirt from getting in.
- If there is a strainer fitted to the oil filler port, do not remove the strainer when adding oil.
- Check that the lubricating oil is at the correct level. The oil level should not be too high or too low.

**[7] CHECKING DRAINED OIL, FILTER**

- When the oil has been changed or the filter replaced, always check the drained oil and removed filter to check for metal particles or other foreign materials.

[8] SETTING UP WARNING SIGNS

- When the oil or coolant has been drained, put warning signs (Part No.: 1-41010-1210) in the operator's compartment to prevent anyone from starting the engine by mistake.

[9] PRECAUTIONS WHEN WASHING PARTS

- When washing parts, use a non-flammable washing agent or diesel oil.
When using diesel oil, do not bring lighted cigarettes or cigarette lighters close.

[10] PRECAUTIONS WHEN INSTALLING PARTS

- When O-rings, gaskets, or other seals are used for the mounting surface, clean the mounting surface and always replace the seal with a new part.

[11] PRECAUTIONS WHEN CARRYING OUT INSPECTION AND MAINTENANCE OF A MACHINE AFTER OPERATIONS IN DUSTY AREAS

- Check carefully for clogging of the air cleaner, and clean the air cleaner element more frequently.
- Clean the radiator core, oil cooler core and inter cooler core more frequently to prevent clogging.
- Replace the fuel filter more frequently.
- Clean electrical parts carefully (in particular, the starting motor or alternator) to prevent dust from collecting.

[12] PRECAUTIONS WHEN CARRYING OUT INSPECTION AND MAINTENANCE ON MACHINES BEFORE STARTING OPERATIONS IN SWAMPY AREAS, RAIN, RIVERBEDS, OR SNOW

- Before starting operations, check that the drain plug under the engine and the greasing plugs for the track rollers are securely tightened.
- After completion of operations, wash the machine carefully and check for cracks and damage, and for loose or missing nuts and bolts.



3. USE OF FUEL AND LUBRICANTS ACCORDING TO AMBIENT TEMPERATURE

3.1 FUEL, COOLANT, AND LUBRICANT TABLE

NOTICE

- Engine oil has a substantial impact on the performance, service life, and starting performance of the engine. So, be sure to use engine oil with the grade API CJ-class 4, ACEA E class 9, or genuine Caterpillar CEO-ULS (SAE 10W-30) with specified viscosity (refer to the table below).
- Be sure to use low sulfur light oil (with sulfur content of 15 ppm or below) as fuel. Never use additives such as antifreeze agents, water solubilizers, etc., Using them can damage the fuel injection system. Never use substitute fuels such as irregular bio-based fuel heating oil that can cause machine failure.

- Select the fuel and oil from the table below according to the ambient temperature.
- The specified capacity is the total amount of oil, including the oil in the piping of the various components.
- The refill capacity is the amount of oil added when changing the oil during inspection and maintenance.
- When starting the engine in an ambient temperature of lower than 0 deg C, always use a grade specified for temperatures below 0 deg C, even if the temperature goes up to 10 deg C during the daytime.
- For the coolant mixture ratio of cooling water, see "Operation 7. Cold Weather Operation".

RESERVOIR	KIND OF FLUID	AMBIENT TEMPERATURE								CAPACITY	
		-22 -30	-4 -20	14 -10	32 0	50 10	68 20	86 30	104°F 40 °C	Specified	Refill
Engine oil pan	Engine oil	SAE15W-40								17.9ℓ 4.73 US gal 3.94 UK gal	16.5ℓ 4.36 US gal 3.63 UK gal
		SAE10W-30									
Hydraulic oil tank	Hydraulic oil	ISO VG56								150ℓ 39.63 US gal 33.00 UK gal	118ℓ 31.18 US gal 25.96 UK gal
		ISO VG46									
		ISO VG32									
Travel motor reduction gear case(each)	Gear oil	SAE90								7.0ℓ 1.85 US gal 1.54 UK gal	-
Swing motor reduction gear case	Gear oil	SAE140								1.8ℓ 0.48 US gal 0.40 UK gal	-
Fuel tank	Diesel fuel	ASTM D975 No.2								300ℓ 79.26 US gal 65.99 UK gal	-
		ASTM D975 No.1									
Cooling system	Water	Long Life Coolant								45ℓ 11.89 US gal 9.90 UK gal	-



REMARK

- When fuel sulphur content is less than 0.5%, change oil in the oil pan every periodic maintenance hours described in this manual.

Change oil according to the following table if fuel sulphur content is above 0.5%.

Fuel sulphur content	Change interval of oil in engine oil pan
0.5 to 1.0%	1/2 of regular interval
Above 1.0%	1/4 of regular interval

- When starting the engine in an atmospheric temperature of lower than 0°C (32°F), be sure to use engine oil of SAE10W, SAE10W-30 and SAE15W-40, even though an atmospheric temperature goes up to 10°C (50°F) more or less in the day time.
- Use API classification CD as engine oil and if API classification CC, reduce the engine oil change interval to half.
- There is no problem if single grade oil is mixed with multigrade oil (SAE10W-30, 15W-40), but be sure to add single grade oil that matches the temperature in the table.
- We recommend genuine oil which has been specifically formulated and approved for use in engine and hydraulic work equipment applications.

Specified capacity: Total amount of oil including oil for components and oil in piping.

Refill capacity: Amount of oil needed to refill system during normal inspection and maintenance.

ASTM: American Society of Testing and Material

SAE: Society of Automotive Engineers

API: American Petroleum Institute

- Hydraulic oil: Nihon Sekiyu Highland Wide KV46.
★When changing the hydraulic oil, please contact your distributor.



4. TOOLS AND TIGHTENING TORQUES

4.1 INTRODUCTION OF NECESSARY TOOLS

The following tools are needed when carrying out maintenance.

If the tools are broken or worn, please order new tools from your distributor.

No.	Name of tool	Part No.	Remarks
1	Wrench set	0-9100-00000 0-9100-00709 0-9100-00810 0-9100-01113 0-9100-01214 0-9100-01719 0-9100-02224	Width across flats (S1 x S2) 7mm x 9mm 8mm x 10mm 11mm x 13mm 12mm x 14mm 17mm x 19mm 22mm x 24mm
2	Wrench	0-9105-04600	Width across flats 46mm
3	Screw driver (+)	0-9210-00150	
4	Screw driver (-)	0-9200-00200	

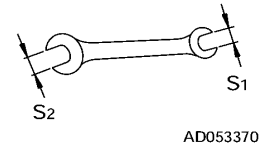



4.2 TORQUE LIST FOR BOLTS AND NUTS

Unless otherwise specified, tighten the metric bolts and nuts to the torque shown in the table below.

The tightening torque is determined by the width across flats (b) of the nut and bolt.

NOTICE

When tightening panels or other parts with tightening fixtures made of plastic, be careful not to use excessive tightening torque. Tightening excessively will damage the plastic parts. Be extremely careful when tightening.

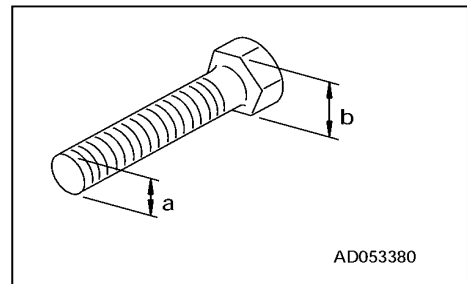

Thread diameter x Width across thread pitch flats (a) (mm x mm)	Width across flats (b) (mm)	Tightening torque (kgf-m) {N-m}	
		Tensile strength 4T	Tensile strength 11T
3x0.5	5.5	0.05 {0.5}	0.2 {1.8}
4x0.7	7	0.1 {1.0}	0.4 {4.1}
5x0.8	8	0.2 {2.2}	0.8 {8.2}
6x1.0	10	0.4 {3.6}	1.4 {14.0}
8x1.25	13	0.9 {8.9}	3.5 {34.0}
10x1.5	17	1.8 {17.7}	6.9 {67.4}
12x1.75	19	3.2 {30.9}	12.0 {117}
14x2.0	22	5.0 {49.1}	19.1 {187}
16x2.0	24	7.8 {76.7}	29.7 {291}
18x2.5	27	10.7 {105}	40.9 {401}
20x2.5	30	15.3 {149}	58.1 {570}
22x2.5	32	20.8 {203}	79.0 {775}
24x3.0	36	26.4 {258}	100 {983}
27x3.0	41	38.6 {378}	147 {1440}
30x3.5	46	52.4 {513}	199 {1955}
33x3.5	50	71.3 {699}	271 {2660}
36x4.0	55	91.6 {898}	348 {3416}
39x4.0	60	119 {1162}	451 {4421}



5. PERIODIC REPLACEMENT OF CRITICAL PARTS

5.1 PERIODIC REPLACEMENT INTERVAL (EVERY 2 YEARS)

In order to further increase the safety of the machine Morooka recommends periodic inspection and replacement of critical parts (hydraulic hoses, fuel hoses, etc.) which are related to causes of fire and to efficiency in the raising and lowering of the dump body and traveling and stopping functions of the machine.

With these parts, the material changes as time passes, and they easily wear or deteriorate. However, it is difficult to judge the condition of the parts simply by periodic maintenance, so they should always be replaced after a fixed time has passed, regardless of their condition. Always replace them with new genuine parts to ensure that the machine always maintains its function completely.

5.2 PERIODIC INSPECTION

⚠ WARNING

- **Check the hydraulic hoses and fuel hoses carefully to check for cracks, deterioration, or other damage, and to check that there is no leakage from the connections. When carrying out checks before starting, always check the ground under the machine to check for traces of oil leakage.**
- **When replacing the hydraulic hoses or fuel hoses, always order genuine parts. Never use any imitation or substitute parts.**
- **When any hydraulic hose is replaced, always replace the O-rings at the same time. Failure to do this will cause oil leakage.**

If the monthly inspection or checks before starting show any abnormality, such as leakage of oil or deformation and cracking, tighten the parts immediately or replace them with new genuine parts.

When doing this, check the hose clamps at the same time, and replace them if they are deformed or cracked.

Check and repair any hydraulic hoses, even if they are not listed as critical parts.

The table below shows the checks to be carried out during periodic maintenance.

Periodic maintenance interval	Inspection items
Checks before starting	<ul style="list-style-type: none"> • Leakage of oil from caulked portions, connections of fuel hoses, hydraulic hoses
Monthly inspection	<ul style="list-style-type: none"> • Leakage of oil from caulked portions, connections of fuel hoses, hydraulic hoses • Damage to fuel hoses, hydraulic hoses (cracks, wear, gouging, swelling, crushing) • Interference with other parts
Every 2 years inspection	<ul style="list-style-type: none"> • Replacement of critical parts • Leakage of oil from caulked portions, connections of fuel hoses, hydraulic hoses • Damage to fuel hoses, hydraulic hoses (cracks, wear, gouging, swelling, crushing) • Interference with other parts



5.3 SPECIFIED PERIODIC REPLACEMENT PARTS

⚠ CAUTION

- The list of periodic replacement parts specified by Morooka does not include the fuel hoses on the engine. Refer to the separate engine parts list (parts book) and carry out replacement in the same way as for the periodic replacement parts specified by Morooka.
- For details of the part numbers for periodic replacement parts specified by Morooka, see the parts list (parts book), and contact your distributor to place orders.

As the periodic replacement parts, the parts shown in the table below should be used.

For details of the parts, see the parts list (parts book).

No.	No. Periodic replacement parts	Q'ty	Replacement interval
1	Fuel hose (fuel tank to fuel injection pump)	1	Replace every 2 years
2	Fuel hose (fuel injection pump to fuel tank)	1	
3	Hydraulic hose (main pump to/from rotary joint to/from left and right travel motors)	8	
4	Hydraulic hose (gear pump to main control valve)	1	
5	Hydraulic hose (main control valve to dump cylinder)	4	
6	Hydraulic hose (main control valve to swing motor)	2	
7	Seat belt	1	Replace every 3 years



6. MAINTENANCE SCHEDULE CHART

Service item	Page
7.2 INITIAL 100 HOURS SERVICE ★This is only after the first 100 hours for new machines	3-14
[1] Change engine lubricating oil, replace engine oil filter	3-30
[2] Replace hydraulic line filter	3-34
[3] Change oil in hydraulic tank	3-35
7.3 INITIAL 500 HOURS SERVICE ★This is only after the first 500 hours for new machines	3-14
[1] Change oil inside travel motor reduction gear case	3-36
7.4 WHEN REQUIRED ★If necessary, carry out these checks every day.	3-15
[1] Check, adjust rubber crawler tension	3-15
[2] Check rubber crawler for damage, wear	3-16
[3] Clean, replace air cleaner	3-17
[4] Clean inside of cooling system and change coolant	3-19
[5] Check, clean radiator, after cooler, fuel cooler, air conditioner condenser fins	3-21
[6] Check, clean oil cooler fins	3-22
[7] Check refrigerant (gas) volume	3-23
[8] Check window washer fluid level, add fluid	3-24
[9] Clean, replace air filter of air conditioner	3-24
[10] Clean, replace fresh filter of air conditioner	3-25
7.5 CHECK BEFORE STARTING ★Always carry out the following checks before starting the engine.	3-26
[1] Check coolant level, add water	3-26
[2] Check fuel level, add fuel	3-27
[3] Check engine lubricating oil level, add oil	3-27
[4] Check oil level in hydraulic tank, add oil	3-28
[5] Check dust indicator	3-29
[6] Check, adjust air compressor belt tension	3-29
[7] Check electric wiring	3-30
[8] Check operation of switches, lamps, gauges	3-30
[9] Check operation of horn, alarm buzzer	3-30
7.6 EVERY 50 HOURS SERVICE	3-31
[1] Drain water, sediment from fuel tank	3-31
[2] Drain water, sediment from water separator	3-31
[3] Check dump body cushion	3-32
7.7 EVERY 100 HOURS SERVICE	3-32
[1] Check battery electrolyte level, add distilled water	3-32
7.8 EVERY 250 HOURS SERVICE	3-33
[1] Grease all parts of dump cylinder	3-33
[2] Grease dump body hinge pin	3-33
[3] Grease track roller pivot shaft	3-33
[4] Grease rear idler shaft	3-34



Service item	Page
7.9 EVERY 500 HOURS SERVICE	3-35
[1] Change engine lubricating oil, replace engine oil filter	3-35
[2] Replace water separator element	3-37
[3] Replace fuel filter	3-39
[4] Replace fuel in-line filter	3-40
[5] Check crankshaft vibration dumper	3-41
[6] Check fan belt	3-41
[7] Replace hydraulic line filter for swing and dump return line	3-42
[8] Replace hydraulic line filter for main pump charging line	3-43
[9] Change oil in hydraulic tank	3-44
[10] Check swing motor reduction gear case oil level, add oil	3-46
[11] Check swing pinion part grease level, add grease	3-47
[12] Grease swing circle bearing	3-47
7.10 EVERY 1000 HOURS SERVICE	3-48
[1] Change oil and grease inside swing motor reduction gear case	3-48
[2] Check alternator	3-49
[3] Check fan belt tensioner	3-49
[4] Check water pump	3-49
7.11 EVERY 1500 HOURS SERVICE	3-49
[1] Change oil inside travel motor reduction gear case	3-49
[2] Replace engine crankcase breather element	3-50
7.12 EVERY 2000 HOURS SERVICE	3-50
[1] Check turbocharger	3-50
[2] Check starting motor	3-50



7. SERVICE PROCEDURE

7.1 OUTLINE OF INSPECTION AND MAINTENANCE PROCEDURES

This section explains the methods for inspection and maintenance operations listed in "6. MAINTENANCE SCHEDULE CHART".

Always observe the precautions related to safety for each item, and carry out the operation safely.

If the operation is difficult, do not try to carry it out; please contact your distributor.

- The operations in this section require the following parts to be removed or opened, and then installed or closed. For details of the procedure, see the following sections.
 - (1) Chassis center inspection cover: See "OPERATION, 2.17 CHASSIS CENTER INSPECTION COVER".
 - (2) Chassis right side inspection cover: See "OPERATION, 2.18 CHASSIS RIGHT SIDE INSPECTION COVER".
 - (3) Battery inspection cover: See "OPERATION, 2.19 BATTERY INSPECTION COVER".
 - (4) Front grill: See "OPERATION, 2.20 FRONT GRILL".

7.2 INITIAL 100 HOURS SERVICE

Carry out the following maintenance after the initial 100 hours breaking-in operation for new machines.

[1] CHANGE ENGINE LUBRICATING OIL, REPLACE ENGINE OIL FILTER

For details of the method of maintenance, see EVERY 500 HOURS SERVICE.

[2] CHANGE OIL IN HYDRAULIC TANK

For details of the method of maintenance, see EVERY 500 HOURS SERVICE.

[2] REPLACE HYDRAULIC LINE FILTER

For details of the method of maintenance, see EVERY 500 HOURS SERVICE.

7.3 INITIAL 500 HOURS SERVICE

Carry out the following maintenance after the initial 500 hours breaking-in operation for new machines.

[1] CHANGE OIL INSIDE TRAVEL MOTOR REDUCTION GEAR CASE

For details of the method of maintenance, see EVERY 1500 HOURS SERVICE.

7.4 WHEN REQUIRED

[1] CHECK, ADJUST RUBBER CRAWLER TENSION

⚠ WARNING

The tension adjuster for the rubber crawler is charged with grease. The grease is kept under high pressure by the recoil spring inside the tension adjuster.

Always follow the precautions given below. Failure to follow these precautions may cause the valve to fly out, resulting in serious injury or accident.

- Never loosen the tension adjustment valve more than one turn. There is danger that the valve may fly out.
- When adjusting the tension, never stand directly in front of the valve. It is dangerous.

• CHECKING TENSION

1. Drive the machine a short distance forward and backward, and then stop the engine.
2. Measure distance **A** from the rear end of the track frame to the center of the idler, and check that it is within the following range.

★Dimension **A**: 425 ± 20 mm

- ★If the result of the measurement shows that dimension **A** is greater than the specified range, adjust the rubber crawler tension. For details, see "ADJUSTING TENSION".

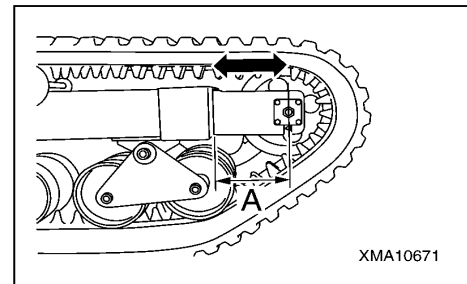

XMA10671

• ADJUSTING WHEN TENSION IS LOOSE (When measurement is below range for dimension A)

- ★Before adjusting, prepare a grease pump.

1. Remove the 2 bolts, and then remove the grease valve cover (1).

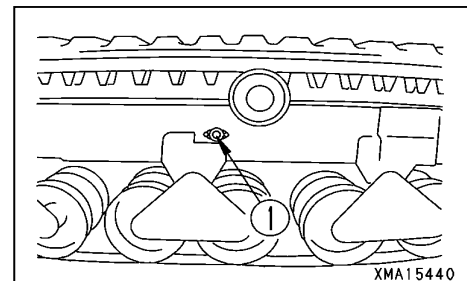

XMA15440

2. Using the grease pump, pump in grease through the valve (2) until dimension **A** is within the range given for "CHECKING TENSION".

★If dimension **A** does not enter the range above even when grease is pumped in, the rubber crawler must be replaced, or there is probably some abnormality in the tension adjuster, so please contact your distributor.

3. Drive the machine a short distance forward and backward to make the tension uniform, and then repeat the steps for "CHECKING TENSION" to measure dimension **A**.

4. Install grease valve cover (1), and then tighten the bolts.

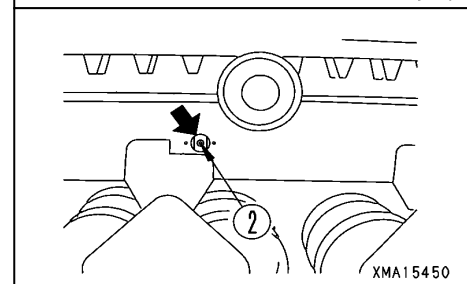

XMA15450



• **ADJUSTING WHEN TENSION IS TIGHT (when measurement is above range for dimension A)**

1. Remove the 2 bolts, and then remove grease valve cover (1).

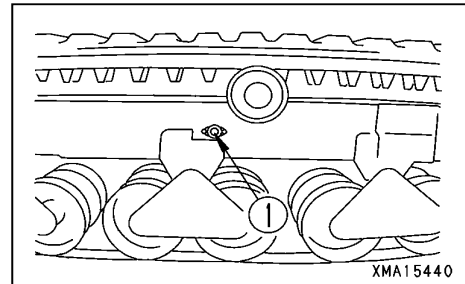

2. Loosen valve (2) until dimension **A** is within the range given for "CHECKING TENSION".

★ If the grease comes out slowly, push the idler end of the rubber crawler strongly.

Never loosen valve (2) more than 1 turn.

★ If the grease still comes out slowly, start the engine and drive the machine a short distance forward and backward.

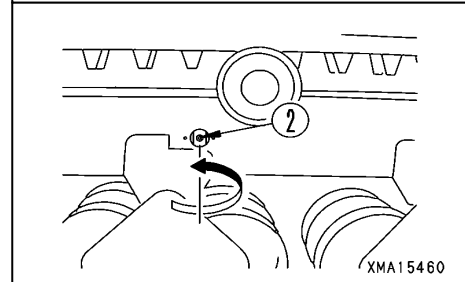

3. Tighten valve (2) securely.

4. Drive the machine a short distance forward and backward to make the tension uniform, and then repeat the steps for "CHECKING TENSION" to measure dimension **A**.

5. Install grease valve cover (1), and then tighten the bolts.

[2] CHECK RUBBER CRAWLER FOR DAMAGE, WEAR

WARNING

If there are any large cracks or damage to the rubber crawler, replace the rubber crawler immediately. There is danger that the rubber crawler may break suddenly without warning during operations.

NOTICE

- When checking the rubber crawler, remove all mud and snow from the crawler before checking.
- Using the rubber crawler when it has exceeded the wear limit will cause slipping and will reduce the drawbar pull. If the rubber crawler is in the following condition, replace it with a new rubber crawler.

• If the height of the lug is less than 1/3 of the standard dimension, replace the rubber crawler.

★ Standard height: 45 mm

★ Wear limit: 15 mm

• If there are cracks or deep cuts and the wire in the core of the rubber crawler can be seen, replace the rubber crawler.

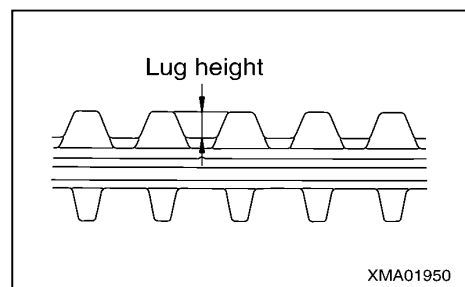

[3] CLEAN, REPLACE AIR CLEANER

⚠ WARNING

- Never clean, or replace the air cleaner when the engine is running.
- When using compressed air to clean the element, there is danger that dirt and dust may fly and get into eyes. Always wear safety glasses.

NOTICE

- When cleaning the outer element, do not hit it or knock it against other objects.
- Do not use the outer element if the folds or seal are damaged.
- Replace the outer element with a new part if it has been cleaned three or four times, or if it has been used for one year. When replacing the outer element, replace the inner element at the same time.
- After cleaning the outer element, if the engine exhaust gas color is black or there is lack of power, replace the outer element. When replacing the outer element, replace the inner element at the same time.
- Never clean the inner element and use it again. Always replace it with a new element.

• CHECK AIR CLEANER

If the dust indicator (1) inside the air cleaner is red, clean the air cleaner element.

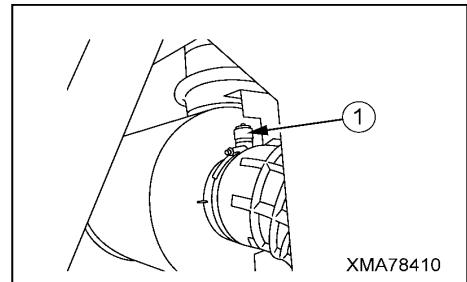

• METHOD OF CLEANING OUTER ELEMENT

1. Remove the 3 catchers (3) at the air cleaner cover, and then remove the air cleaner cover (2).

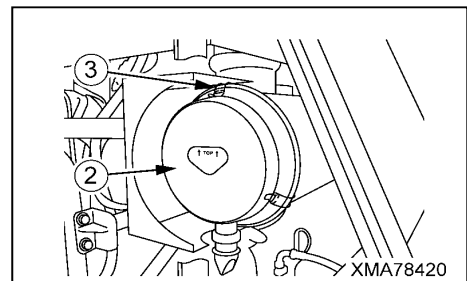

2. Take out the outer element (4).

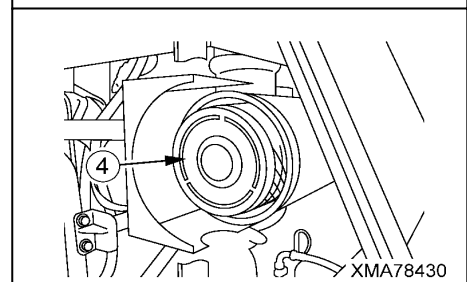

3. Blow with dry compressed air (max. 0.21 MPa) along the folds from the inside of the element (4).

Next, blow along the folds from the outside of the element, and then blow from the inside of the element again.

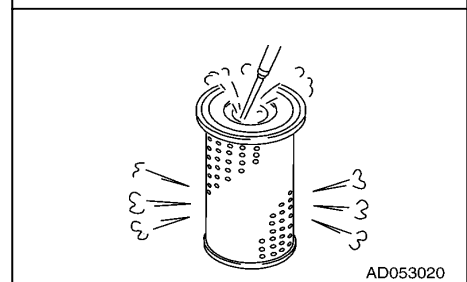



4. After cleaning, use a light bulb from inside the element to check if there are any small holes or thin places in the element. Replace the element if such places are found.

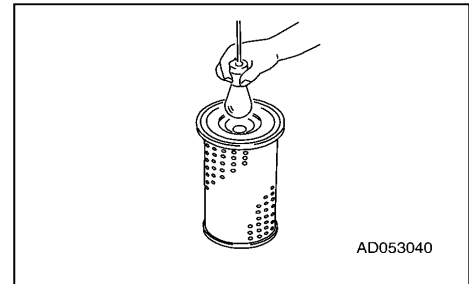

5. After cleaning the outer element (4), insert the outer element (4) to the body.

6. Remove the valve (5) from the air cleaner cover (2), and then clean the inside of the valve and the cover.

7. After cleaning the valve (5) and the air cleaner cover (2), install the valve (5) to the air cleaner cover (2).

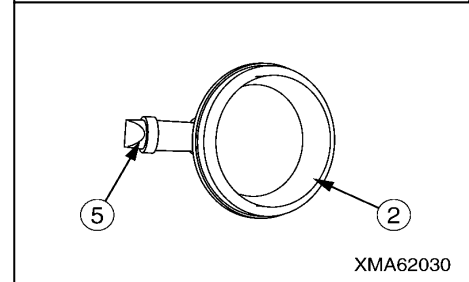

8. Fit the air cleaner cover (2) to the body, then secure with the catcher (3).

★With the air cleaner cove (2), install with the stamped “TOP” mark (6) upward.

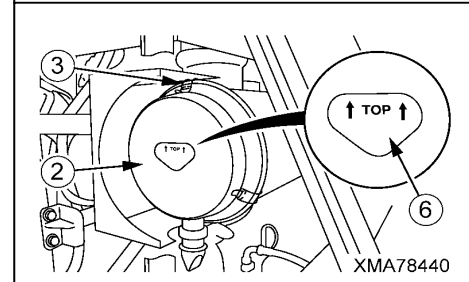

• METHOD OF REPLACING OUTER ELEMENT

Remove the outer element and replace it with a new element.

For details of the procedure, see METHOD OF CLEANING OUTER ELEMENT. When replacing the outer element, replace the inner element at the same time. For details, see METHOD OF REPLACING INNER ELEMENT.

• METHOD OF REPLACING INNER ELEMENT

1. Remove the outer element.

For details of the procedure, see METHOD OF CLEANING OUTER ELEMENT.

2. Take out the inner element (7).

3. Cover the air connector end (air outlet) with a clean cloth or cloth tape.

4. Clean the inside of the body, then remove the cover fitted in Step 3.

5. Insert the new inner element (7) in the body.

6. Install the outer element (4).

For details of the procedure, see METHOD OF CLEANING OUTER ELEMENT.

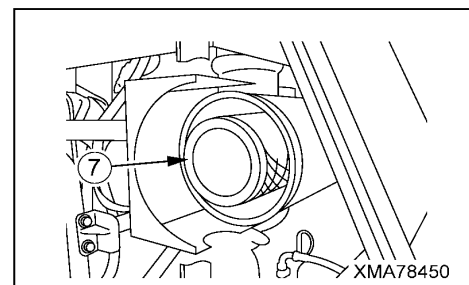

[4] CLEAN INSIDE OF COOLING SYSTEM AND CHANGE COOLANT

⚠ WARNING

- Immediately after the engine is stopped, the coolant is at high temperature, so there is danger of burns if you drain the coolant immediately.
Wait for the engine to cool down before draining the coolant.
- Do not suddenly remove the cap when the radiator water temperature is high. Boiling water will spurt out and cause burns.
Wait for the water temperature to go down before removing the cap. When removing the cap, turn it slowly to fully release the internal pressure, then remove the cap.

NOTICE

- Replace the cooling water (coolant) every year or 2000 running hours whichever comes first.
- For the coolant mixture ratio of cooling water, see "Operation 8. Cold Weather Operation".

Clean the cooling water circuit as follows.

★Use tap water for the coolant.

Do not use river water, well water, or untreated water supplies.

1. Stop the machine on level ground and stop the engine.
2. Climb to the top of the battery box by using step (1) and handrail (2) at the front of the machine.

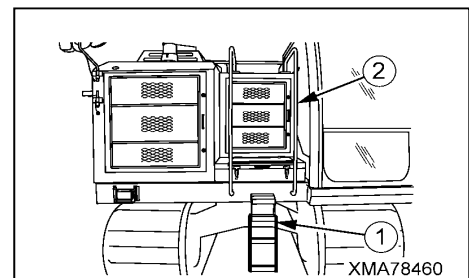

3. Loosen the 2 wing bolts (4) on the radiator guard, and then slide the radiator inspection cover (3) to forward.

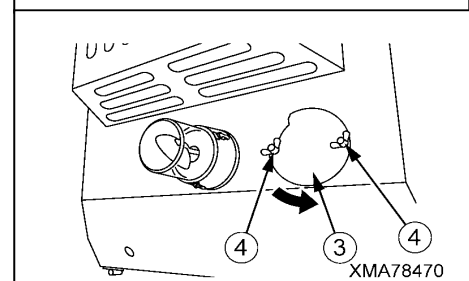

4. Turn the radiator cap (5) slowly to fully release the internal pressure, and remove it.

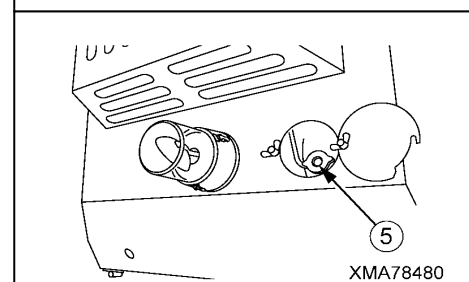

5. Open the front grille.
6. Connect the drain hose (A) to the drain valve (6) at the radiator bottom and open the radiator drain valve (6) to drain the water.

★For drain hose (A), use a hose that can reach the container to receive drainage.

★If there is antifreeze in the coolant, put containers to catch the water under of the drain hose (A).

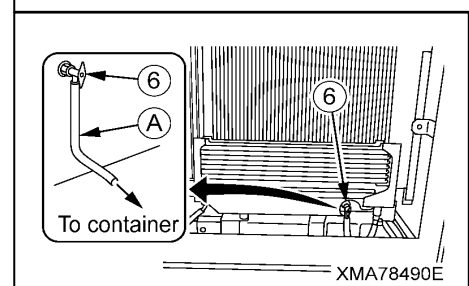

7. After draining the water, close the radiator drain valve (6), then add tap water through the water filler to fill the radiator.
8. Open the radiator drain valve (6), then start the engine, run at low idling, and run water through the system to flush it for 10 minutes.
 - ★While running water through the cooling system to flush it, be careful to adjust the water flow so that the radiator is always full.
 - ★While running water through the cooling system to flush it, be careful that the water supply hose does not slip out of the water filler.
9. After flushing the system, stop the engine, stop the water supply, and then drain the water.
10. After draining the water, close the radiator drain valve (6), then add cleaning agent through the water filler.
 - ★For details of the method of cleaning, see the instructions on the cleaning agent.
11. After flushing with cleaning agent, open the radiator drain valve (6), drain the water, then start the engine, run at low idling, and flush with water until clean water comes out.
 - ★While running water through the cooling system to flush it, be careful to adjust the water flow so that the radiator is always full.
 - ★While running water through the cooling system to flush it, be careful that the water supply hose does not slip out of the water filler.
12. When clean water comes out, stop the engine, and close the radiator drain valve (6).
13. Disconnect the drain hose (A) from the drain valve (6).
14. Add tap water through the water filler to fill the radiator.
15. Start the engine, run for 5 minutes at low idling, then run for a further 5 minutes at high idling to remove the air from the coolant.
 - ★Leave the radiator cap removed when doing this.
16. Stop the engine, leave for approx. 3 minutes, then add tap water to near the top of the water filler, and tighten the radiator cap (5).
17. Slide the radiator inspection cover (3) to original position and tighten the 2 wing bolts (4).

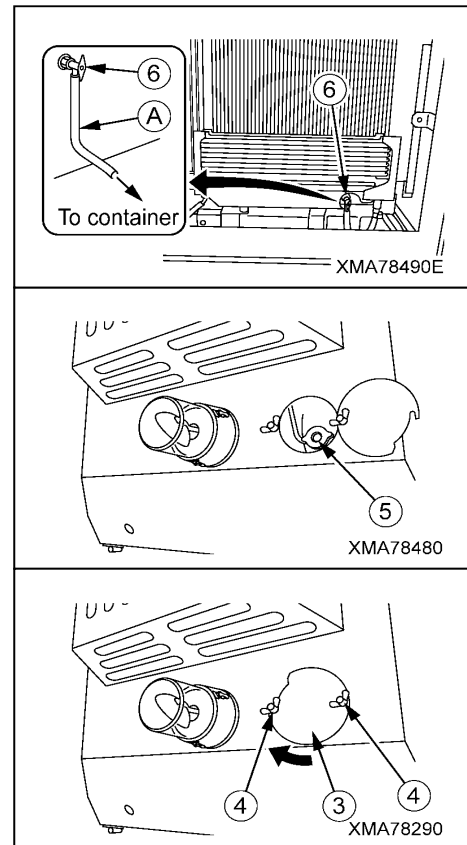

[5] CHECK, CLEAN RADIATOR, AFTER COOLER, FUEL COOLER, A/C CONDENSOR FINS

⚠ WARNING

- Never inspect or clean the fins when the engine is running. Always stop the engine before starting the operation.
- When using compressed air to clean the fins, there is danger that dirt and dust may fly and get into eyes. Always wear safety glasses.

NOTICE

- When cleaning the fins, use compressed air at a pressure of less than 0.29Mpa, and stand away from the fins when directing the compressed air. If the compressed air is blown directly against the fins or is blown at high pressure, the fins will be damaged and this will cause leakage of water, air or oil.
- When cleaning the fins, do not use steam or water instead of compressed air. This causes clogging.

1. Open the front grill.
2. Check for mud, dirt, dead leaves, or waste paper clogging the radiator fins (1), after cooler fins (2), fuel cooler fins (3) at under side or the air conditioner condenser fins (4).
3. If the result of the inspection shows that the fins are clogged, blow with dry compressed air (0.29 MPa) to clean.
4. After cleaning the fins, close the front grill.

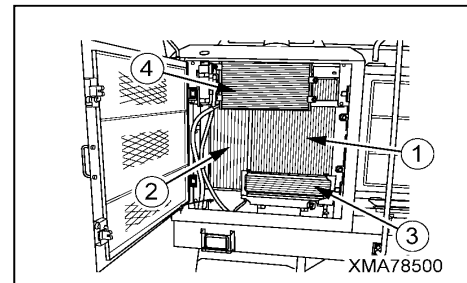

[6] CHECK, CLEAN OIL COOLER FINS

⚠ WARNING

- Never inspect or clean the oil cooler fins when the engine is running. Always stop the engine before starting the operation.
- When using compressed air to clean the oil cooler fins, there is danger that dirt and dust may fly and get into eyes. Always wear safety glasses.

NOTICE

- When cleaning the oil cooler fins, use compressed air at a pressure of less than 0.29Mpa, and stand away from the fins when directing the compressed air. If the compressed air is blown directly against the oil cooler is blown at high pressure, the fins will be damaged and this will cause leakage of oil.
- When cleaning the oil cooler fins, do not use steam or water instead of compressed air. This causes clogging.

1. Press top and bottom buttons (2) in of oil cooler grille to release the lock.
2. Grip handle (3) of oil cooler grille (1) and open oil cooler grille (1) toward you.

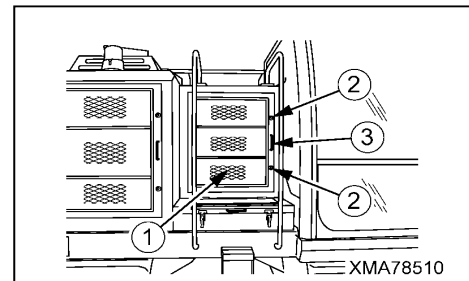

3. Remove rod (4) at the lower part of the rear surface of oil cooler grille (1) and install it to the lock position on the frame to secure oil cooler grille (1).

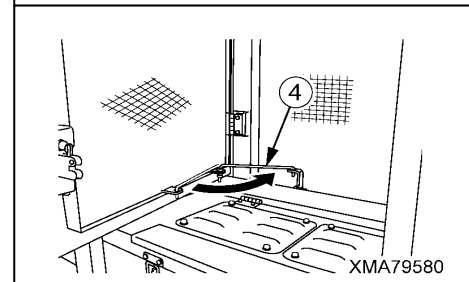

4. Check for mud, dirt, dead leaves, or waste paper clogging the oil cooler fins (5).
5. If the result of the inspection shows that the fins are clogged, blow with dry compressed air (0.29 MPa) to clean.
6. After checks and cleaning, remove rod (4) from the lock position on the frame and return it to the original position at the lower part of oil cooler grille (1).
7. Close oil cooler grille (1) and press handle (1) in. At this time, oil cooler grille (1) is locked.

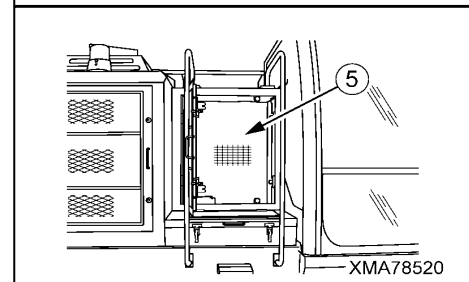

[7] CHECK REFRIGERANT (GAS) VOLUME

⚠ WARNING

- If the refrigerant used in the cooler gets into your eyes or on to your hands, it may cause loss of sight or frost bite. Never loosen or remove any part of the refrigerant circuit.
- Always ask your refrigerant dealer to charge the cooler with refrigerant.

NOTICE

- If the cooler is operated when it has run out of refrigerant or the refrigerant level is low, the compressor will be damaged. Always check the refrigerant level before using the cooler.
- Even in the off-season when the cooler is not being used, run the cooler for 3 to 5 minutes once a month.

- Check the volume of refrigerant in the cooler through the top of the receiver which is charged with gas or through sight gauge (2). Receiver (1) is mounted on the left side of the condenser inside the front grill.

Open the front grill to carry out inspection.

- Check the volume of refrigerant in the cooler as follows.
 1. Remove rubber cover (3) for the inspection hole at the top of the radiator guard and check through the inspection hole.

2. Start the engine and run at high idling.
3. Set the control panel inside the operator's compartment to cooling and run at high speed.
4. Look through receiver (1) or sight gauges (2) (inspection window) to check the condition of the gas flowing in the refrigerant circuit. Compare it with the table below to judge the condition.

Judgment of refrigerant level	Condition in sight gauge
Suitable	No bubbles in refrigerant flow
Low level	Continuous bubbles in refrigerant flow
Empty	Sight gauge is colorless, transparent

5. Open the front grill.
6. Check for oil oozing out from the connection of the piping of the receiver (1). If there is oil oozing out, gas is leaking.
7. Close the front grill.
8. Install the rubber cover (3).

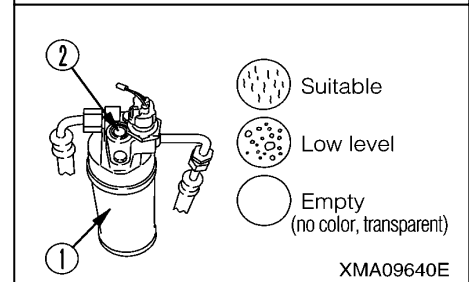
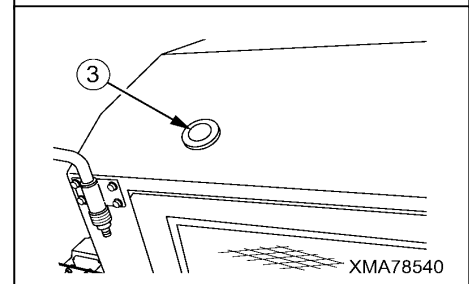
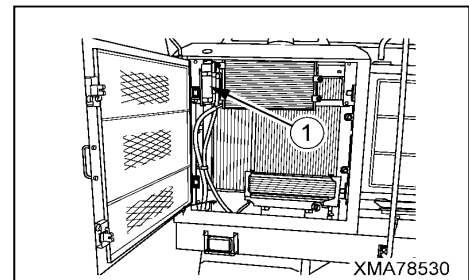



[8] CHECK WINDOW WASHER FLUID LEVEL, ADD FLUID

- ★The washer tank is installed to the outside at the rear of the cab.
- ★The washer fluid reservoir is installed in front of the tool box at the rear of the cab.
- ★When checking or adding window washer fluid, raise the dump body.

• CHECKING, FILLING

If the window washer fluid does not come out, check the level of the fluid in washer tank (1).

If the level is low, remove the cap (2) from the washer tank and fill with automobile window washer fluid.

- ★ When filling with fluid, be careful not to let dirt get in.

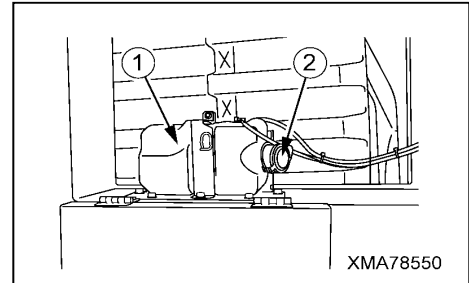

• Mixing RATIO FOR WINDOW WASHER FLUID

Change the mixture ratio of the window washer fluid according to the ambient temperature.

Mix the concentrated window washer fluid with tap water according to the proportions given in the table below, and then fill the washer tank.

- ★There are two types of concentrated window washer fluid: the general type for use at freezing temperatures of -10°C (14°F), and a cold weather type for use in temperatures down to -30°C (-22°F). Select the type according to the territory and season.

Territory, season	Mixing proportion		Freezing temperature
	Concentrated fluid	Tap water	
Normal	1/3	2/3	-10°C (14°F)
Winter in cold area	1/2	1/2	-20°C (-4°F)
Winter in extremely cold area	Use undiluted washer fluid	None	-30°C (-22°F)

[9] CLEAN, REPLACE AIR FILTER OF AIR CONDITIONER

NOTICE

- If the air filter is not cleaned for long periods, the cooling and heating effect of the air conditioner will drop. It will also cause breakage of the equipment.
- When cleaning the air filter, do not use compressed air or wash with water.
- If the air filter is markedly damaged or deteriorated, replace it with a new part. We recommend that you replace the filter once a year even if it is not damaged or deteriorated.

Air conditioner is at the bottom left of the front face of the air intake duct at the rear of the operator's compartment.

1. Grip notch of the air filter (1) to release lock and then slide the air filter (1) up and remove it.
2. Remove the filter from the filter holder.
3. Tap the filter lightly to remove the dust and dirt.
4. After cleaning, insert the air filter (1) in its original position.

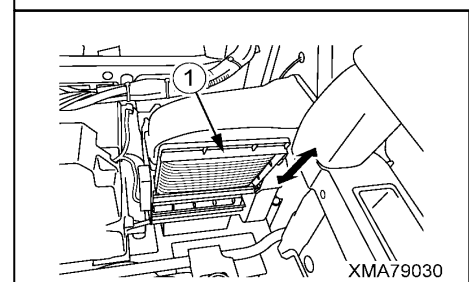
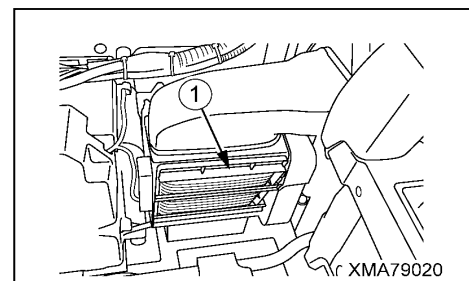

[10] CLEAN, REPLACE FRESH FILTER OF AIR CONDITIONER

! WARNING

- If the fresh air filter is not cleaned for long periods, the cooling and heating effect of the air conditioner will drop. It will also cause breakage of the equipment.
- When cleaning the fresh air filter, do not use compressed air or wash with water.
- If the fresh air filter is markedly damaged or deteriorated, replace it with a new part. We recommend that you replace the filter once a year even if it is not damaged or deteriorated.

The air conditioner fresh air filter is located under the cover on the left side cover of the cab outside surface.

1. Use the key to release the lock (2) of cover (1).
2. Open cover (1).

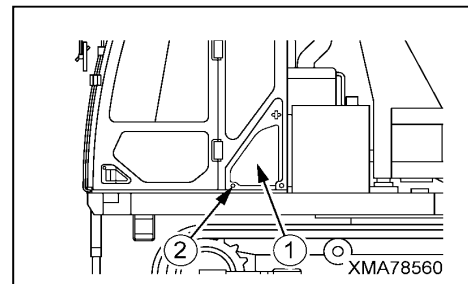

3. Pull notch (4) at the top of the fresh air filter toward you to take out fresh air filter (3).
 4. Tap the filter lightly to remove the dust and dirt.
 5. After cleaning, check the filter (3) and replace it with a new part if it is damaged or extremely dirty.
 6. Install the fresh air filter (3) in the opposite order to removal.
- ★To install the fresh air filter, first fit the protrusion at the bottom of fresh air filter (3) to guide (5), then press notch (4) at the top in.

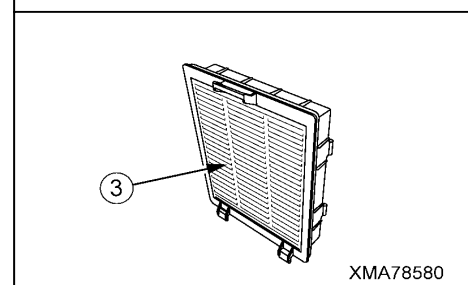
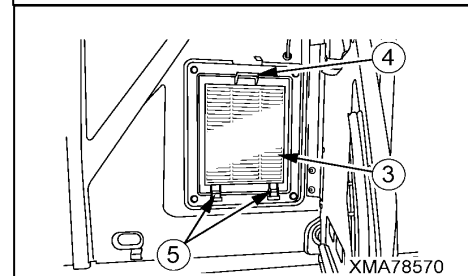

7.5 CHECK BEFORE STARTING

[1] CHECK COOLANT LEVEL, ADD WATER

⚠ WARNING

Do not suddenly remove the cap when the radiator water temperature is high. Boiling water will spurt out and cause burns.

Wait for the water temperature to go down before removing the cap. When removing the cap, turn it slowly to fully release the internal pressure, then remove the cap.

NOTICE

If the result of the coolant level check shows that more water must be added than usual, there is probably a water leak, so search for the cause and repair the problem immediately.

1. Grip handle (3) of oil cooler grille (1) and open oil cooler grille (1) toward you.

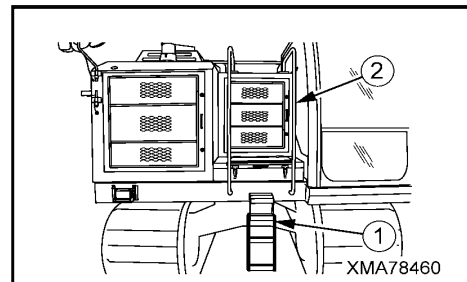

2. Loosen the 2 wing bolts (4) on the radiator guard, and then slide the radiator inspection cover (3) to forward.

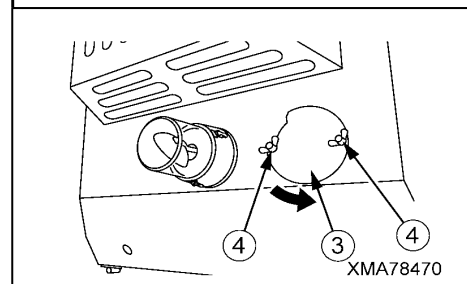

3. Turn the radiator cap (5) slowly to fully release the internal pressure, and remove it.

4. Check the coolant level is close to the bottom of the filler port.

If the coolant level is low, add tap water.

5. After adding water, tighten the cap (5) securely.

6. Slide the radiator inspection cover (3) to original position and tighten the 2 wing bolts (4).

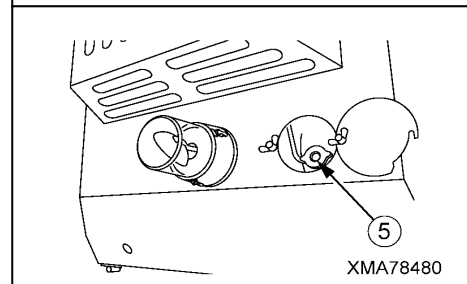



[2] CHECK FUEL LEVEL, ADD FUEL

⚠ DANGER

When adding fuel, never let the fuel overflow from the tank. This will cause fire.

1. Check the fuel level with level gauge (1) at the side face of the fuel tank.

If the machine is not filled up, refill with fuel.

2. Release the lock on the cap (2) with a key and remove the cap (2) from the fuel tank and add fuel through the fuel filler.

3. Check the breather hole on the inside of the cap, and if it is clogged, wash it.

4. After adding fuel, tighten the cap (2) securely and lock up with a key.

★Use low sulfur light oil (light oil with sulfur content of 15 ppm or below) as fuel.

★Always fill the fuel tank after completing the day's operation.

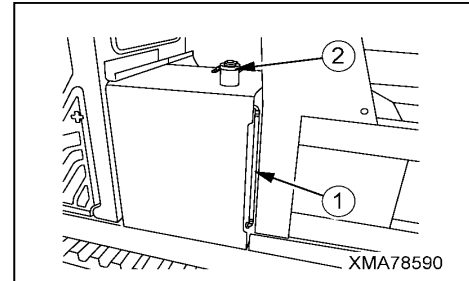

[3] CHECK ENGINE LUBRICATING OIL LEVEL, ADD OIL

⚠ WARNING

After raising the dump body, be sure to set the safety bar to prevent the dump body from lowering.

• CHECKING OIL LEVEL

1. Raise the dump body.

2. Open the chassis center inspection cover.

3. Pull out the dipstick (1) at the engine under left side and wipe the oil off with a cloth.

4. Insert the dipstick (1) fully into the gauge guide, and then pull out again.

5. The oil level should be between FULL and ADD lines on the dipstick (1). If the oil level is below ADD line, add engine oil.

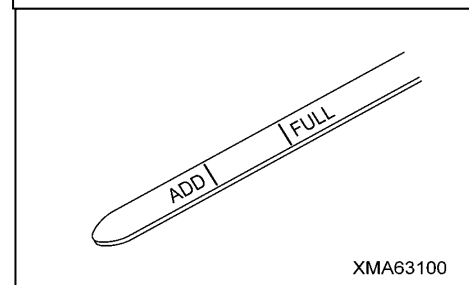
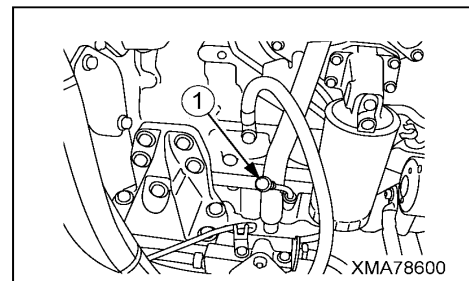

• FILLING WITH OIL

1. Release the catcher (8) of the inspection cover (7) and open the inspection cover (7).

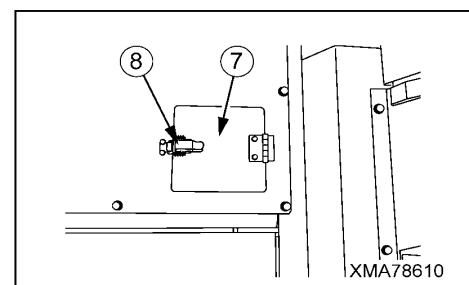



2. Remove the cap (2) and add engine oil.
 - ★ For details of the engine oil, see “3. USE OF FUEL AND LUBRICANTS ACCORDING TO AMBIENT TEMPERATURE”.
 - ★ Use a container with an attached hose when filling with oil.
3. Check the oil level again, and if it is within the specified range, tighten the cap (2) securely.
4. Close the engine inspection cover (7) and fit the catcher (8).
5. Close the chassis center inspection cover.

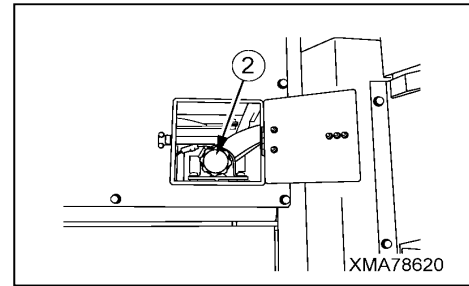

[4] CHECK OIL LEVEL IN HYDRAULIC TANK, ADD OIL

⚠ WARNING

After raising the dump body, be sure to set the safety bar to prevent the dump body from lowering.

• CHECKING OIL LEVEL

1. Raise the dump body.
2. Open the chassis center inspection cover.
3. After Standing at inspection step, lower the dump body.
4. Use the level gauge (1) at the side face of the hydraulic tank to check the oil level and the condition of dirt in the oil.

The oil level should be between the top and bottom red lines on the gauge.

If the oil level is low, add hydraulic oil.

 - ★ Check the oil level in the hydraulic tank with the dump body being lowered.

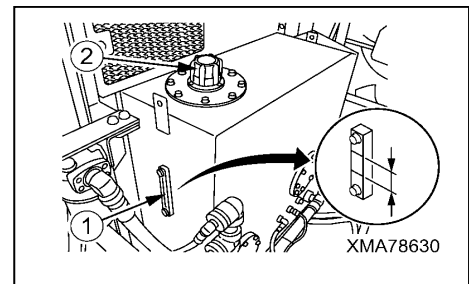

• FILLING WITH OIL

1. Turn the cap (2) of the hydraulic tank slowly to fully release the internal pressure, then remove it and add hydraulic oil through the oil filler.
 - ★ Check the oil level in the hydraulic tank with the dump body being lowered.
 - ★ For details of the hydraulic oil, see “3. USE OF FUEL AND LUBRICANTS ACCORDING TO AMBIENT TEMPERATURE”.
2. Check the breather hole inside the cap and clean it if it is clogged.
3. After adding oil, tighten the cap (2) securely.
4. Close the chassis center inspection cover.

[5] CHECK DUST INDICATOR

⚠ WARNING

After raising the dump body, be sure to set the safety bar to prevent the dump body from lowering.

1. Raise the dump body.
2. Check if the red piston has appeared in the transparent portion of the dust indicator (1).
If the red piston has appeared, clean or replace the element immediately.
★For details of the method of cleaning the element, see “7.4 WHEN REQUIRED”.
★After checking, cleaning, or replacing, push the knob of the dust indicator to return the red piston to its original position.

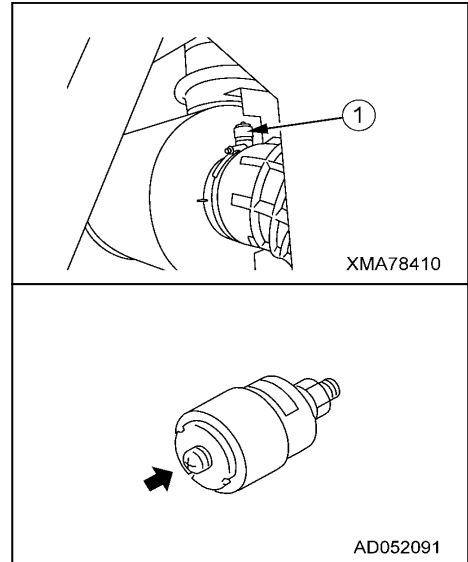

[6] CHECK, ADJUST COMPRESSOR BELT TENSION

• CHECKING TENSION

1. Open the chassis right side inspection cover.
2. Push with your finger (approx. 58.8 N) at a point midway between the fan pulley (1) and compressor pulley (2). The deflection should be approx.10 mm.
3. If the deflection is too large, adjust the belt tension. For details, see “ADJUSTING TENSION”.

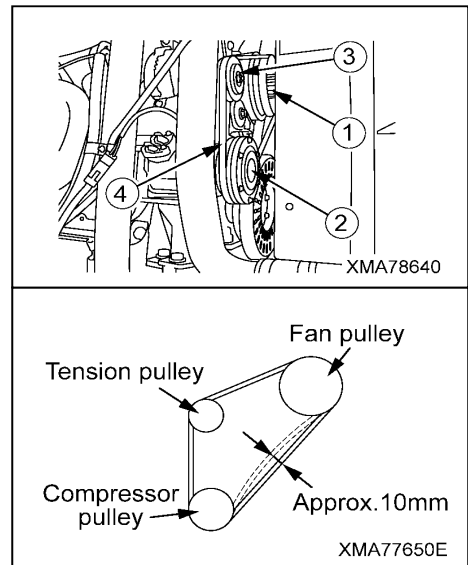

• ADJUSTING TENSION

1. Turn the adjustment bolt (6) at the top of the tension pulley bracket (5) clockwise to adjust the belt deflection to approx. 10 mm. When this is done, tension pulley (3) comes up.
2. Repeat the procedure for checking the tension and check the belt tension again.
3. Close the chassis right side inspection cover.

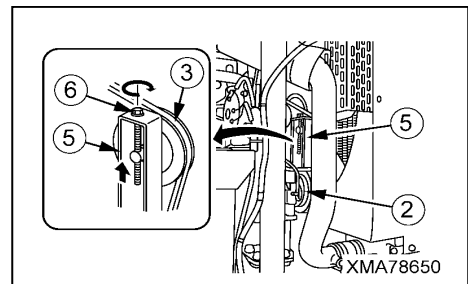



[7] CHECK ELECTRIC WIRING

⚠ DANGER

If any tool touches between the battery positive (+) terminal and the chassis, there is danger that sparks will be caused. Do not put tools and other metal objects in your breast pocket. They may fall out.

- Open the battery inspection cover at front center of the chassis, and check for looseness of the battery terminal, looseness of the ground connection and battery relay wiring, and for signs of short circuits.
- Open the chassis center inspection cover, and check at the inspection step at chassis center for loose starting motor wiring and signs of short circuits.
- Open the chassis right side inspection cover, and check loose alternator wiring and signs of short circuit.

[8] CHECK OPERATION OF SWITCHES, MONITOR DISPLAY, LAMPS, GAUGES

- Turn the starting switch to the ON position and check that the monitor display indicator light up.
 - ★If any indicator does not light up, so contact your distributor.
- Turn the starting switch to the ON position, and operate light switches and turn signal switches in the combination switch to check whether respective lamps light up. Also check whether indications corresponding to respective switches light up on the monitor display.
 - ★If any lamp does not light up, the bulb is probably blown or there is a disconnection, so contact your distributor.
 - ★If the monitor display does not display it, contact your distributor.
- Turn the starting switch to the ON position and press the Hi-Lo speed range selector switch to check whether "High-speed travel (H)" on the monitor display lights up.
 - ★If the monitor display does not display it, contact your distributor.
- Turn the starting switch to the ON position and press the parking brake switch to ON (STOP) position, to check whether "Parking brake (P)" on the monitor display lights up.
 - ★If the monitor display does not display it, contact your distributor.
- Turn the starting switch to the ON position, and press the swing lock switch at ON (upside) to check whether "swing lock lamp" on the monitor display box lights up.
 - ★If lamp does not light up, the bulb is probably blown or there is a disconnection, so contact your distributor.
- Turn the starting switch to the ON position, operate the wiper switch, and check that the wiper motor action.
 - ★If wiper motor does not acting, there is probably a failure or disconnection in the wiper motor, so contact your distributor.
- Turn the starting switch to the ON position, operate the air conditioner controller, and check that the air conditioner function.
 - ★If air conditioner does not function, there is probably a failure or disconnection in the air conditioner unit, so contact your distributor.

[9] CHECK OPERATION OF HORN, ALARM BUZZER

- Turn the starting switch to the ON position, push the horn switch inside the combination switch or swing and dump control lever top end position, and check that the horn sounds.
 - ★If the horn does not sound, there is probably a failure or disconnection in the horn, so contact your distributor.
- Turn the starting switch to the ON position, operate the parking brake switch to the ON (STOP) position and check that the buzzer sounds.
 - ★If the parking brake buzzer does not sound, there is probably a failure or disconnection in the buzzer, so contact your distributor.

7.6 EVERY 50 HOURS SERVICE

[1] DRAIN WATER, SEDIMENT FROM FUEL TANK

★Set a container under the fuel tank to catch the fuel.

1. Remove the 10 bolts (6) of the undercover (5) under the upper revolving structure, and remove it.

★Swing the upper revolving structure so that you can see the undercover (5).

2. Turn the drain plug (1) under the fuel tank to the left (Counter clockwise) slightly.

The water and sediment accumulated at the bottom of the tank will be drained together with the fuel.

3. After completely draining the sediment and water, tighten the drain plug (1) under the fuel tank.

4. Set the undercover (5) to the upper revolving structure and tighten bolts (6).

★Swing the upper revolving structure to the original position.

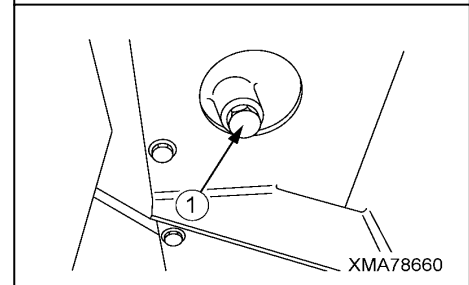
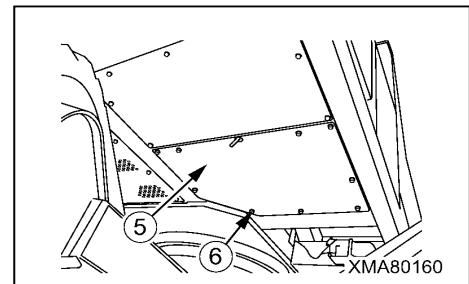

[2] DRAIN WATER, SEDIMENT FROM WATER SEPARATOR

⚠ WARNING

After raising the dump body, be sure to set the safety bar to prevent the dump body from lowering.

★Set a container under the water separator to catch the fuel.

★The water separator is installed at the left bottom of the engine.

1. Raise the dump body.
2. Open the chassis center inspection cover.
3. Loosen the bent screw (2) at the top of the water separator.

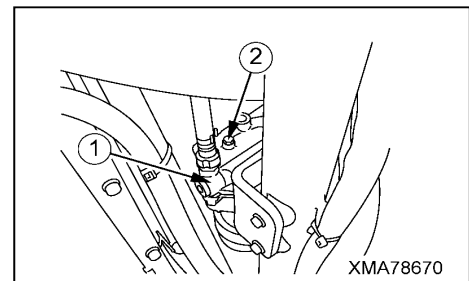

4. Connect appropriate tube (A) to water drainage (3) on the lower surface of water separator (1).

★Put the outlet side of tube (A) in the container to receive fuel.

5. Rotate water drain valve (4) to the left (counterclockwise) 2 turns.

Both sediment at the bottom of water separator (1) and mixed water are discharged together.

6. After completing discharge of sediment and mixed water, remove tube (A) from water drainage (3) on the lower surface of water separator (1).

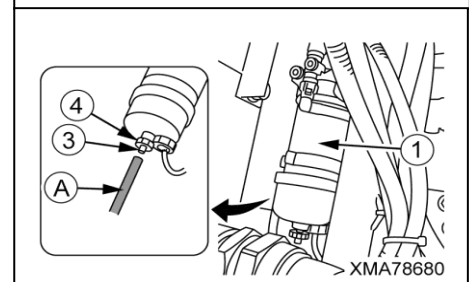

7. Rotate water drain valve (4) to the right (clockwise) to close it.

8. Tighten the bent screw (2) on the water separator securely.

9. Close the chassis center inspection cover.

[3] CHECK DUMP BODY CUSHION

⚠ WARNING

After raising the dump body, be sure to set the safety bar to prevent the dump body from lowering.

1. Raise the dump body.
2. Check 6 mounting bolts (2) of dump body cushions (1) on both sides for looseness and if missing. Retighten loose bolts and be sure to install new bolts if they are missing.
 - ★When replacing mounting bolt (2), be sure to install a new bolt along with washer (3) and pipe (4).
 - ★Mounting bolt (2) size: M10X50 mm
3. Check the condition of dump body cushions (1) on both sides, and replace them with new ones if large defects or peel-off is found.

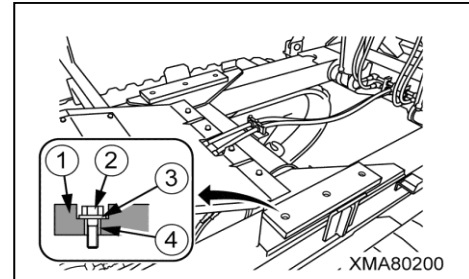

7.7 EVERY 100 HOURS SERVICE

★Carry out “every-50 hours service” at the same time.

[1] CHECK BATTERY ELECTROLYTE LEVEL, ADD DISTILLED WATER

⚠ DANGER

- If any tool touches between the battery positive (+) terminal and the chassis, there is danger that sparks will be caused. Do not put tools and other metal objects in your breast pocket. They may fall out.
- Be careful not to get battery electrolyte on yourself or on your clothes.
- Do not bring any lighted cigarette or cigarette lighter close.

1. Open the battery inspection cover.
2. Remove all battery caps (2) and check the battery electrolyte level. The battery electrolyte level should be approx. 10 - 12 mm above the plate.
3. If the battery electrolyte level is low, add distilled water.
 - ★From time to time, measure the specific gravity of the battery, and charge if necessary.
4. Close the battery inspection cover.

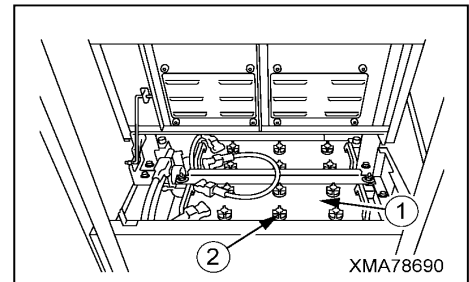

7.8 EVERY 250 HOURS SERVICE

Carry out "every-50 hours service and every-100 hours service" at the same time.

[1] GREASE ALL PARTS OF DUMP CYLINDER

⚠ WARNING

After raising the dump body, be sure to set the safety bar to prevent the dump body from lowering.

★Prepare a grease pump.

1. Raise the dump body.
2. Grease the bottom (left and right: 2 places) of the dump cylinder (1).

★Continue greasing until old grease is extruded.

3. Grease the piston rod (left and right: 2 places) of the dump cylinder (1).

★Continue greasing until old grease is extruded.

4. After greasing, wipe off extruded old grease.

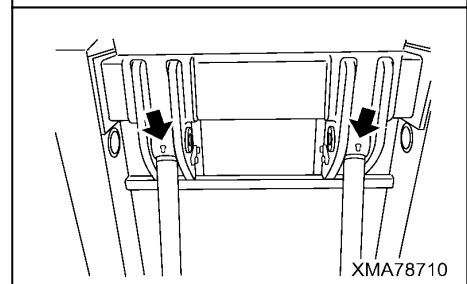
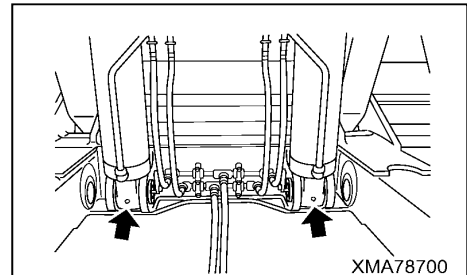

[2] GREASE DUMP BODY HINGE PIN

⚠ WARNING

After raising the dump body, be sure to set the safety bar to prevent the dump body from lowering.

★Prepare a grease pump.

1. Raise the dump body.
2. Grease the dump body hinge pin position (1) (left and right: 2 places).

★Continue greasing until old grease is extruded.

3. After greasing, wipe off extruded old grease.

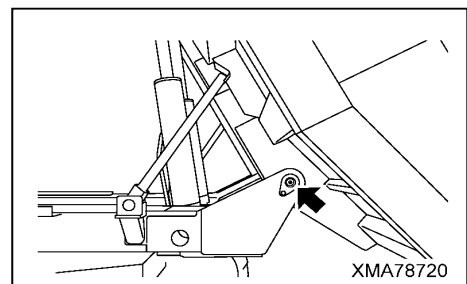

[3] GREASE TRACK ROLLER PIVOT SHAFT

★Prepare a grease pump.

1. Grease the shaft position (left and right: 8 places) of the track roller pivot shaft (1).

★Continue greasing until old grease is extruded.

2. After greasing, wipe off extruded old grease.

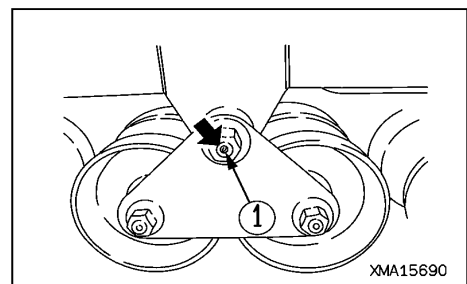

**[4] GREASE REAR IDLER SHAFT**

★Prepare a grease pump.

1. Grease the shaft position (left and right: 2 places) of the rear idler shaft (1).

★Continue greasing until old grease is extruded.

2. After greasing, wipe off extruded old grease.

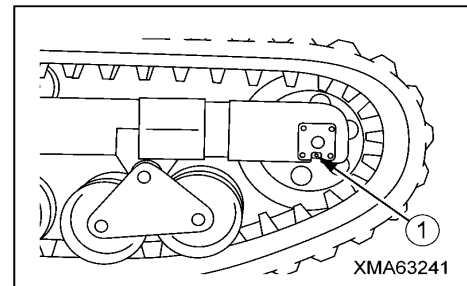

7.9 EVERY 500 HOURS SERVICE

Carry out “every-50 hours, every-100 hours and every-250 hours service” at the same time.

[1] CHANGE ENGINE LUBRICATING OIL, REPLACE ENGINE OIL FILTER

⚠ WARNING

- After raising the dump body, be sure to set the safety bar to prevent the dump body from lowering.
- Stop the engine and wait for the temperature to go down.
- After adding oil, tighten the cap and drain plug securely, then wipe up any spilled oil.

★Set a container under the inspection cover at under of engine to catch the oil.

★Prepare a filter wrench.

★The engine oil filter is installed at the engine left side.

1. Start the engine, and slightly swing the upper revolving structure to the left (counterclockwise) so that engine bottom inspection cover (9) is away from the crawler top surface. Then, stop the engine.
2. Go under the machine and remove the 4 bolts (9) and remove the engine bottom inspection cover (9).
3. Raise the dump body.
4. Open the chassis center inspection cover.

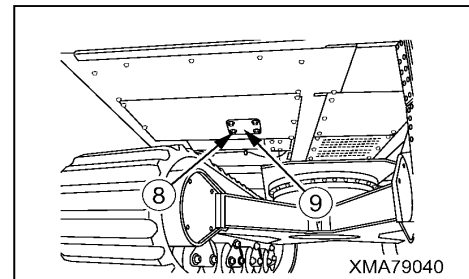

5. Connect the drain hose (A) to the drain plug (3) of the oil pan.

★The length of drain hose (A) shall be enough to extend from the hole in engine bottom inspection cover (7) removed in Step 2 to the oil container placed on the ground.

6. Turn the handle (4) to counter clockwise of the drain valve (3) from the engine oil pan and drain the oil.
7. Check the drained oil.

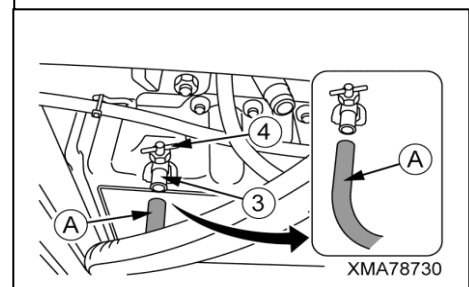

★If there are large amounts of metal particles or dirt in the drained oil, please contact your distributor.

8. After completely draining the oil, turn the handle (4) to the right (Clockwise) of the drain valve (3) to close the drain valve (3).
9. Disconnect the drain hose (A) from the drain plug (3) of the oil pan..
10. Go under the machine and set the engine bottom inspection cover (9) to original position and tighten the 4 bolts (9) and install.

11. Use the filter wrench, turn the oil filter cartridge (5) to the left (Counter clockwise) and remove it.

12. Clean the oil filter mount, coat the packing surface of the new oil filter cartridge with engine oil, and then install it to the mount.

★Fill the Engine oil into the new filter cartridge.

★When installing a new filter cartridge, always tighten it by hand, and be careful not to tighten it too much.

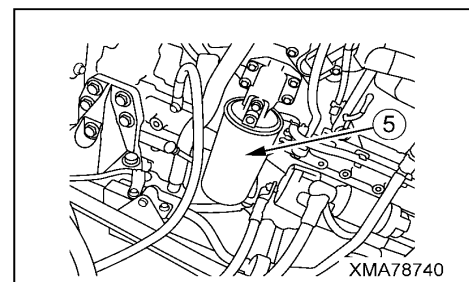

13. Release the catcher (8) of the inspection cover (7) and open the inspection cover (7).

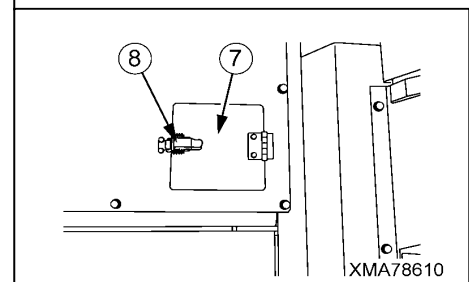



14. Remove the filler cap (2) and add the specified amount of engine oil.
 - ★ For details of the oil to use, see “3. USE OF FUEL AND LUBRICANTS ACCORDING TO AMBIENT TEMPERATURE”.
 - ★ Engine oil refill amount: 16.5 liters (4.36 US gal, 3.63 UK gal)
 - ★ Use a container with an attached hose when filling with oil.
15. Start the engine, run at idling for several minutes, then check that the oil level. For details, see “7.5 CHECK BEFORE STARTING”.
16. After refilling with oil, check the oil level again to check that the oil level is in normal range.
 - When the oil level is in normal range, close oil filler cap (2) securely.
17. Close the engine inspection cover (7) and fit the catcher (8).
18. Close the chassis center inspection cover.

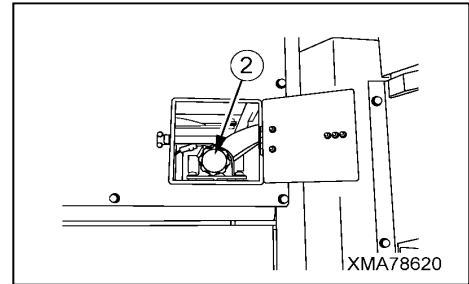

[2] REPLACE WATER SEPARATOR

⚠ WARNING

- After raising the dump body, be sure to set the safety bar to prevent the dump body from lowering.
- Stop the engine and wait for the engine to cool down.
- Do not smoke or bring any flame close.
- If any fuel leaks or overflows, always wipe it up immediately. If fuel gets on any high-temperature part, it will cause fire.

NOTICE

- After replacing the water separator, bleed the air from the fuel circuit.
- When replacing the water separator, take care not to fill a new water separator with fuel. That fuel is not filtered, and it can cause early wear of component parts of the fuel system.

★Set a container under the water separator to catch the fuel.

★Prepare a filter wrench.

★The water separator is installed at the bottom left of the engine.

1. Raise the dump body.
2. Open the chassis center inspection cover.
3. Loosen the bent screw (2) at the top of the water separator (1).
4. Connect appropriate tube (A) to water drainage (3) on the lower surface of water separator (1).
 - ★Put the outlet side of tube (A) in the container to receive fuel.
5. Rotate water drain valve (4) to the left (counterclockwise) 2 turns. Both sediment at the bottom of water separator (1) and fuel are discharged together.
6. After completing discharge of sediment and fuel, remove tube (A) from water drainage (3) on the lower surface of water separator (1).
7. Rotate water drain valve (4) to the right (clockwise) to close it.
8. Tighten the bent screw (2) at the top of the water separator (1) securely.
9. Disconnect the wiring connector (5) at bottom of the water separator.

10. Use the filter wrench, turn the bowl (6) of the water separator (5) to the left (Counter clockwise) and remove it.

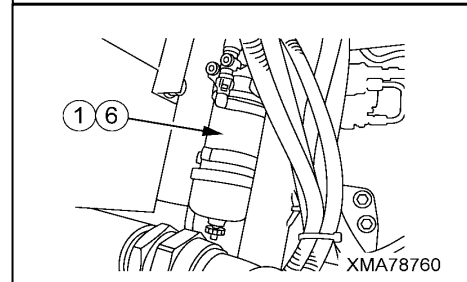
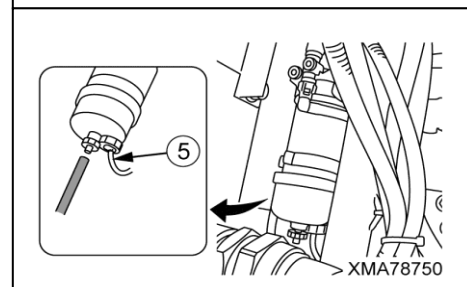
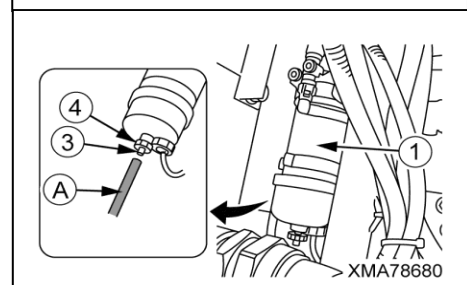
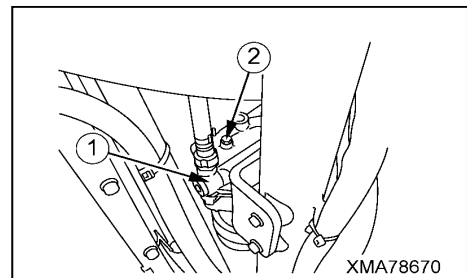



11. Pull the filter element (7) to the left (Counter clockwise) out from the bowl (6).
12. Clean the bowl (6) and inside of the water separator mounting portion.

13. Slightly rotate new filter element (7) to both sides to align thread (9) with thread (10) in bowl (6).
14. Turn the filter element (7) to the right (Clockwise) and tighten the water drain valve (4) securely.
15. Coat the clean engine oil to the O-ring (8) at the top of the filter element (7).

16. Turn the bowl (6) to the right (Clockwise) and install it to the water separator mounting portion.
 - ★When installing bowl (6), do not use a filter wrench.
 - ★Finger tighten bowl (6) to install it.
 - Rotate bowl (6) until it is locked by the stop.
17. Close the chassis center inspection cover.

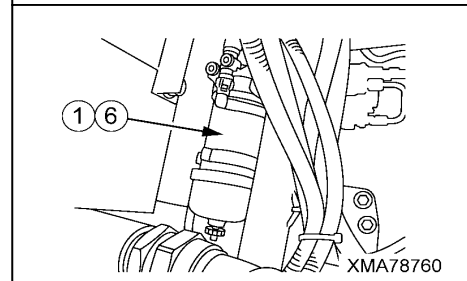
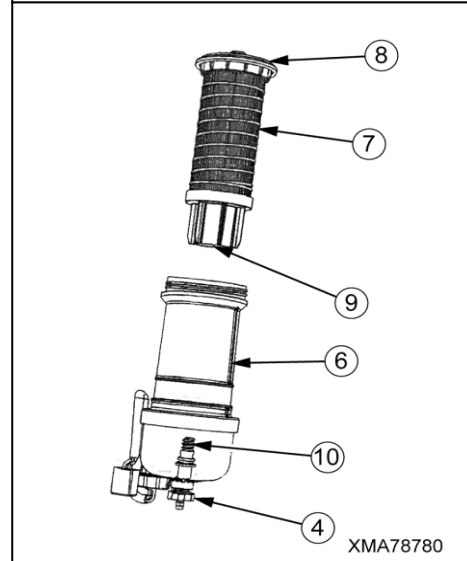
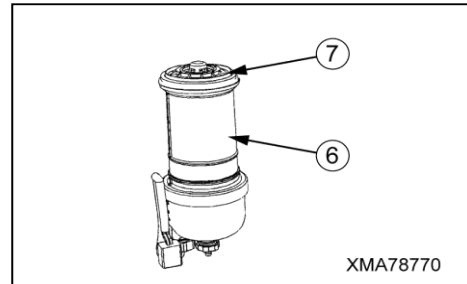

[3] REPLACE FUEL FILTER

⚠ WARNING

- After raising the dump body, be sure to set the safety bar to prevent the dump body from lowering.
- Stop the engine and wait for the engine to cool down.
- Do not smoke or bring any flame close.
- If any fuel leaks or overflows, always wipe it up immediately. If fuel gets on any high-temperature part, it will cause fire.

NOTICE

- After replacing the fuel filter, bleed the air from the fuel circuit. For details, see the separate Operation and Maintenance Manual for the engine.
- When replacing the fuel filter, take care not to fill a new fuel filter with fuel. That fuel is not filtered, and it can cause early wear of component parts of the fuel system.

★Set a container under the fuel filter to catch the fuel.

★Prepare a filter wrench.

★The fuel filter (1) is installed at the top left of the engine.

1. Raise the dump body.

2. Open the chassis center inspection cover.

3. Loosen bent screw (2) at the top of the fuel filter (1).

4. Connect appropriate tube (A) to water drainage (3) on the lower surface of fuel filter (1).

★Put the outlet side of tube (A) in the container to receive fuel.

5. Rotate water drain valve (4) to the left (counterclockwise) 2 turns.

Fuel inside fuel filter (1) is discharged.

6. After completing discharge of fuel, remove tube (A) from water drainage (3) on the lower surface of fuel filter (1).

7. Rotate water drain valve (4) to the right (clockwise) to close it.

8. Tighten bent screw (2) at the top of the fuel filter (1) securely.

9. Use the filter wrench, turn the bowl (5) of the fuel filter (1) to the left (Counter clockwise) and remove it.

10. Pull the filter element (6) to the left (Counter clockwise) out from the bowl (5).

11. Clean the bowl (5) and inside of the water separator mounting portion.

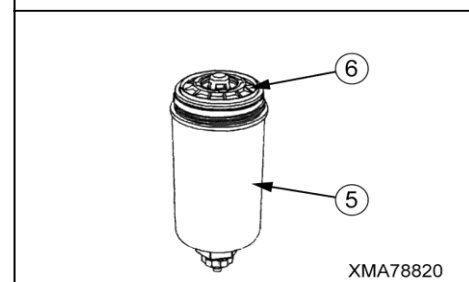
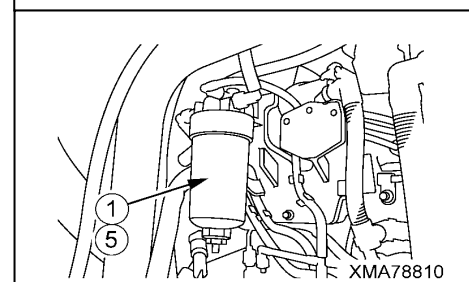
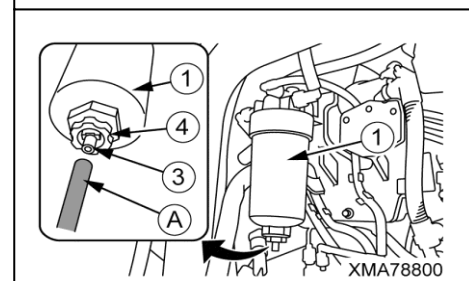
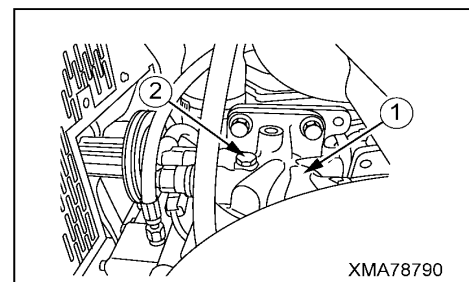

12. Slightly rotate new filter element (6) to both sides to align thread (8) with thread (9) in bowl (5).
13. Turn the filter element (6) to the right (Clockwise) and tighten the water drain valve (4) securely.
14. Coat the clean engine oil to the O-ring (7) at the top of the filter element (6).
15. Turn the bowl (5) to the right (Clockwise) and install it to the fuel filter mounting portion.
 - ★When installing bowl (5), do not use a filter wrench.
 - ★Finger tighten bowl (5) to install it.
 - Rotate bowl (5) until it is locked by the stop.
16. Close the chassis center inspection cover.

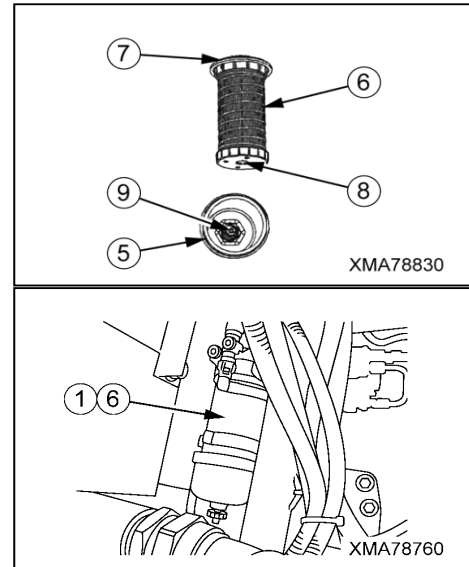

[4] REPLACE FUEL IN-LINE FILTER

⚠ WARNING

- After raising the dump body, be sure to set the safety bar to prevent the dump body from lowering.
- Stop the engine and wait for the engine to cool down.
- Do not smoke or bring any flame close.
- If any fuel leaks or overflows, always wipe it up immediately. If fuel gets on any high-temperature part, it will cause fire.

- ★Set a container under the fuel in-line filter to catch the fuel.
 - ★The fuel in-line filter (1) is installed at the bottom left of the engine.
1. Raise the dump body.
 2. Open the chassis center inspection cover.
 3. Loosen the hose clip (4) and disconnect the fuel hose (2) of the fuel tank side and fuel hose (3) of the priming pump side from fuel in-line filter (1).
 4. Remove the 2 bolts (6) and remove the 2 clamps (5).
 5. Take out the fuel in-line filter (1) from the clamp (5).
 6. Set new fuel in-line filter (1) to clamp (5), and install it to the original position in reverse order to removal.
 - ★When setting fuel in-line filter (1) in position, be sure to place fuel in-line filter (1) with its arrow mark facing toward the priming pump side from the fuel tank side.
 7. Close the chassis center inspection cover.

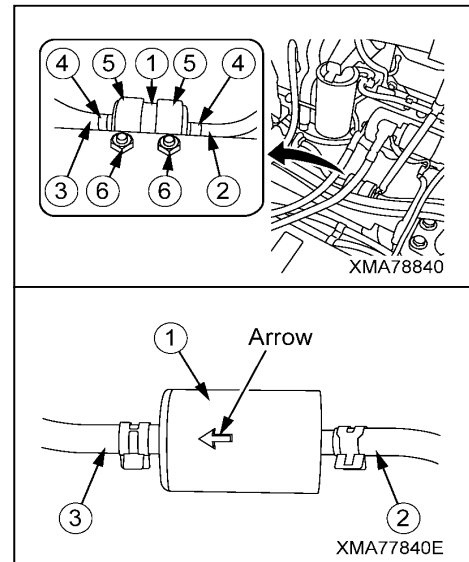

[5] CHECK CRANKSHAFT VIBRATION DAMPER

1. Open the chassis center inspection cover.
2. Visually check crankshaft vibration damper (1).
 - ★Check that the cooling fan for the crankshaft vibration damper is clean and free from dust and dirt.
 - ★If any dent, crack, or leak is found on the crankshaft vibration damper, contact your distributor.
3. Close the chassis center inspection cover.

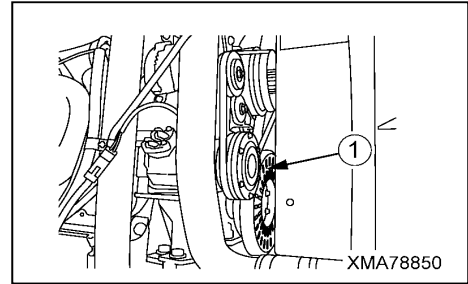

[6] CHECK FAN BELT

1. Open the chassis right side inspection cover.
2. Check fan belt (1) for wear, cracks, and fracture.
 - Also check for cord displacement, contamination by grease and oil.
3. As the results of inspection, if any of followings is found,
 - Cracks are found in one or more ribs of the belt.
 - Displacement extending a maximum of "50.8 mm" is found in one or more locations of one rib of one belt.

The fan belt needs to be replaced. Contact your distributor.
4. Close the chassis center inspection cover.

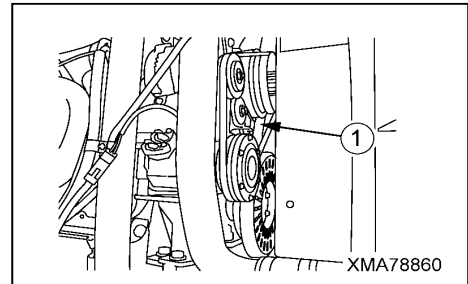

[7] REPLACE HYDRAULIC LINE FILTER FOR SWING AND DUMP RETURN LINE

⚠ WARNING

- After raising the dump body, be sure to set the safety bar to prevent the dump body from lowering.
- Wait for the oil temperature to go down.
- Loosen the cap of the hydraulic tank slowly to release the internal pressure completely, then remove the cap.

NOTICE

When replacing the hydraulic line filter, always change the oil in the hydraulic tank at the same time.

- ★Set a container under the hydraulic line filter to catch the oil.
- ★The hydraulic line filter is installed at the rear side of the hydraulic tank.
 1. Raise the dump body.
 2. Remove the drain plug (2) of the line filter (1) and drain the oil.
 3. Setting a spanner to the nut portion (3) being positioned at the lower section of the case of the line filter, turn it toward left (Counter clockwise) to remove the filter case (4).
 4. Remove the O-rings (6), (7) inside the filter head (5).
 5. Clean the filter head (5).
 6. Take out the element (8) in the filter case (4), and wash the filter case (4).
 7. Fit the new O-rings (6), (7) in to the filter head (5).
 8. Inserting a new element (8) into the filter case (4), screw it in into the filter body section (5).
 - ★When inserting the element (8) into the filter case (4), be careful not to let the spring (9) inside the filter case (4) collapse.
 - ★Fill the hydraulic oil to the filter case.

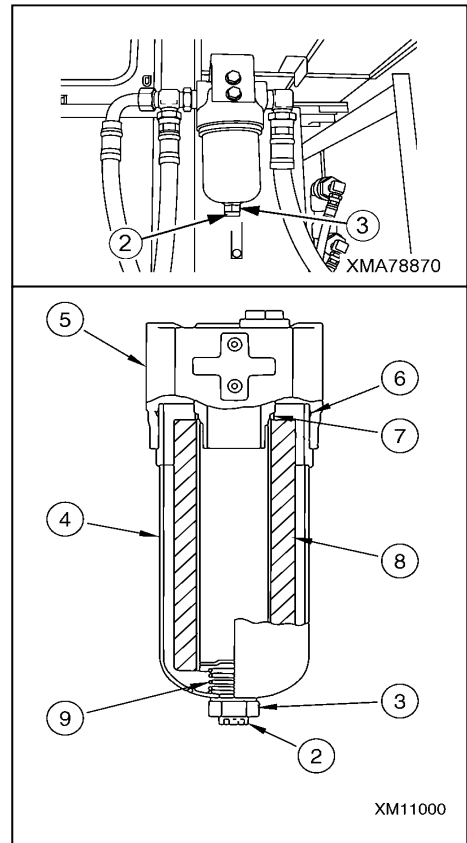

[8] REPLACE HYDRAULIC LINE FILTER FOR MAIN PUMP CHARGING LINE

⚠ WARNING

- Wait for the oil temperature to go down.
- Loosen the cap of the hydraulic tank slowly to release the internal pressure completely, then remove the cap.

NOTICE

When replacing the hydraulic line filter, always change the oil in the hydraulic tank at the same time.

★Set a container under the hydraulic line filter to catch the oil.

★The hydraulic line filter is installed at the rear left side of the engine.

1. Open the chassis right side inspection cover.
2. Remove the drain plug (2) of the line filter (1) and drain the oil.
3. Setting a spanner to the nut portion (3) being positioned at the lower section of the case of the line filter, turn it toward left (Counter clockwise) to remove the filter case (4).
4. Remove the O-rings (6), (7) inside the filter head (5).
5. Clean the filter head (5).
6. Take out the element (8) in the filter case (4), and wash the filter case (4).
7. Fit the new O-rings (6), (7) in to the filter head (5).
8. Inserting a new element (8) into the filter case (4), screw it into the filter body section (5).
- ★When inserting the element (8) into the filter case (4), be careful not to let the spring (9) inside the filter case (4) collapse.
- ★Fill the hydraulic oil to the filter case.
9. Close the chassis right side inspection cover.

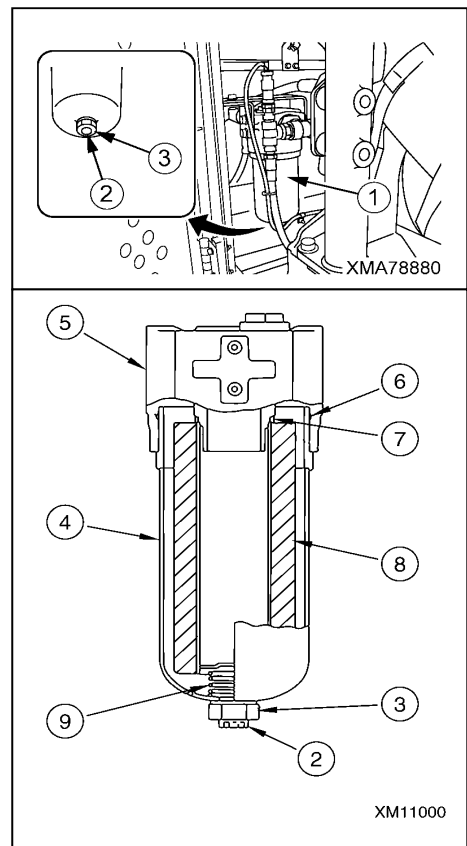

[9] CHANGE OIL IN HYDRAULIC TANK

⚠ WARNING

- Lower the dump body, then stop the engine and wait for the temperature to go down.
- Loosen the oil filler cap slowly to release the pressure inside the hydraulic tank, then remove the cap.
- After adding oil, tighten the cap and drain plug securely, then wipe up any spilled oil.

NOTICE

- When changing the oil in the hydraulic tank, always replace the hydraulic line filter at the same time.
- Always replace the O-ring used inspection cover inside the hydraulic tank with a new O-ring.

★Set a container under the hydraulic tank to catch the oil.

1. Raise the dump body.
2. Open the chassis center inspection cover.
3. After Standing at the inspection step, lower the dump body.
4. Turn the cap (2) of the hydraulic tank slowly to fully release the internal pressure, then remove and add hydraulic oil through the oil filler.

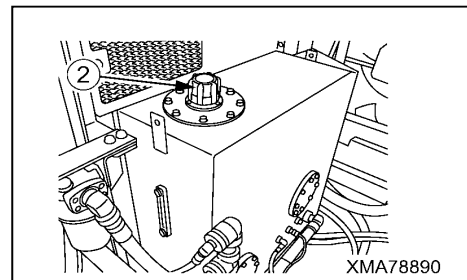

5. Go under the machine, and then remove 6 bolts (10) and remove the undercover (9) of the upper revolving structure.

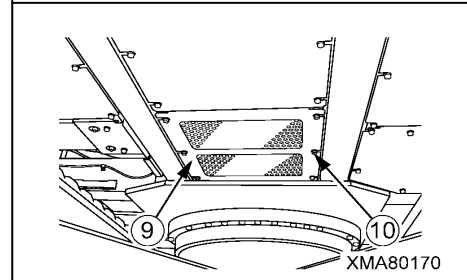

6. Turn drain plug (3) at the bottom of the hydraulic tank to the left (Counter clockwise) and drain the oil inside the hydraulic tank.

★Set the container under the hydraulic tank to catch the oil.

★Be careful not to get oil on yourself.

7. Inspect the drained oil.
 - ★If there are large amounts of metal particles or dirt in the drained oil, please contact your distributor.

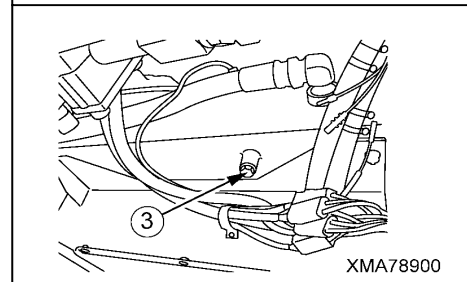

8. After completely draining the oil, tighten drain plug (3).
9. Set the undercover (9) of the upper revolving structure to original position and tighten the bolts (10).
10. Remove the 12 bolts (12), and remove the inspection step (11) at the chassis center portion.

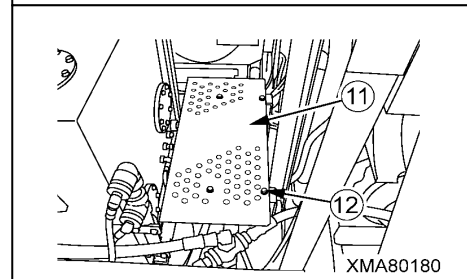

11. Remove the 8 bolts (5) and remove the inspection cover (4).

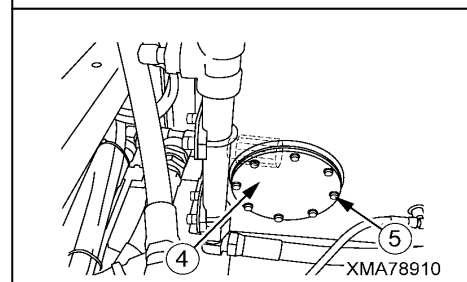



12. Take out the oil strainer (6) from the hydraulic tank, then wash it in diesel oil.
13. Install the oil strainer (6) inside the hydraulic tank, set new O-ring (7) to the hydraulic tank, then install inspection cover (4) and tighten the bolts (5).
14. Set the inspection step (11) at the chassis center portion to the original position and tighten the bolts (12).
15. Fill with hydraulic oil through the oil filler.
 - ★For details of the hydraulic oil to use, see “3. USE OF FUEL, COOLANT, AND LUBRICANT ACCORDING TO AMBIENT TEMPERATURE”.
 - ★Hydraulic oil refill amount: 118 liters (31.18 US gal, 25.96 UK gal)
 - ★Use a container with an attached hose when filling with oil.
16. Check that the oil level is between the top and bottom red lines on the level gauge at the rear of the hydraulic tank. For details, see “7.5 CHECK BEFORE STARTING (4)”.
17. Close the chassis center inspection cover.

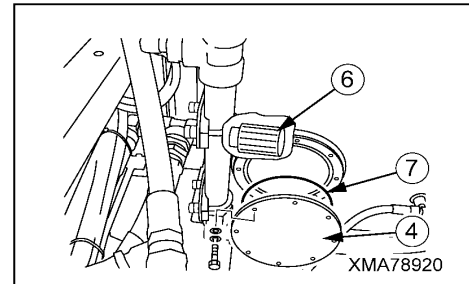

[10] CHECK SWING MOTOR REDUCTION GEAR CASE OIL LEVEL, ADD OIL

⚠ WARNING

- After raising the dump body, be sure to set the safety bar to prevent the dump body from lowering.
- Wait for the oil temperature to go down.
- After adding oil, insert the dipstick fully and Close the filler cap securely, and then wipe up any spilled oil.

1. Raise the dump body.
2. Remove catcher (2) at the front of the chassis rear side cover and open inspection cover (1).

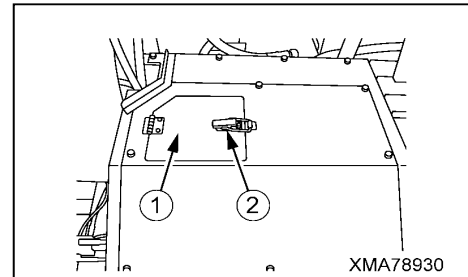

3. Pull out the dipstick (3) and wipe the oil off with a cloth.
4. Insert the dipstick (3) fully into the gauge guide, and then pull out again.
5. The oil level should be between "H" and "L" lines on the dipstick (3).
6. If the oil level is below "L" line, Remove the filler cap (4) and add gear oil.

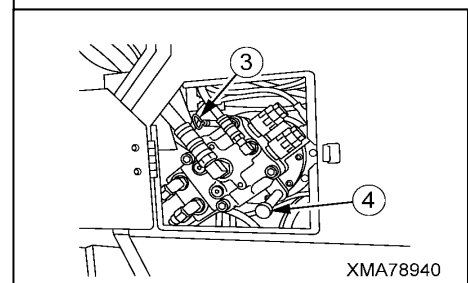

- ★ Be sure to pull out oil level gauge (3) before refilling with oil.
- ★ After adding gear oil, close the filler cap (4) securely.

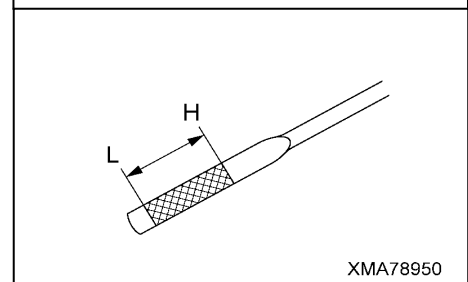

[11] CHECK SWING PINION PART GREASE LEVEL, ADD GREASE

⚠ WARNING

- After raising the dump body, be sure to set the safety bar to prevent the dump body from lowering.
- Wait for the oil temperature to go down.

1. Raise the dump body.
2. Remove the 8 bolts (2) at the front and rear side of the chassis rear side cover (1) and remove the chassis rear side cover (1).

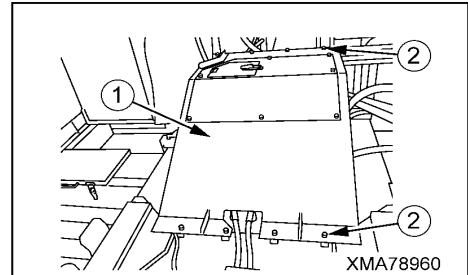

3. Remove the 4 bolts (4) and remove the inspection cover (3).

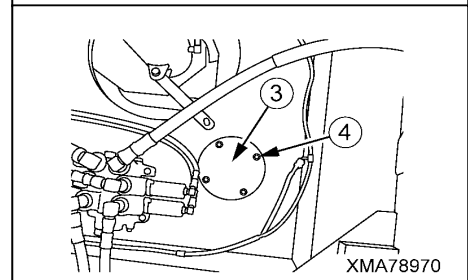

4. Check whether the grease circulates to the swing gear through the inspection port.

If insufficient, refill with grease of about "0.5 liter".

5. Check the grease for white turbidity.
6. If the grease becomes milky due to mixing of water, dirt, etc., enter the space under the center bottom of the upper revolving structure, remove 4 mounting bolts (6) of inspection cover (5), and discharge old grease. Refill with new grease through the inspection hole.
7. After changing the grease, set the inspection cover (5) to the original position, and tighten the bolts (6).
8. Set the inspection cover (3) to the original position, and tighten the bolts (4).
9. Set the chassis rear side cover (1) to the original position, and tighten the bolts (2).

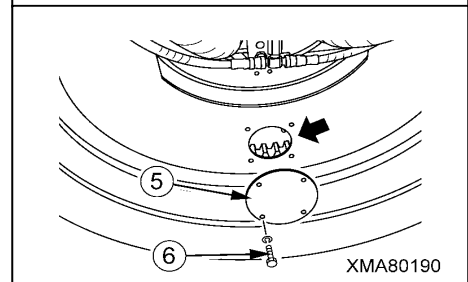
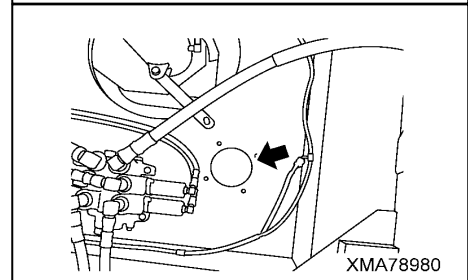

[12] GREASE SWING BEARING

★Prepare a grease pump.

1. Enter under the machine, pump in grease from the swing bearing outer circumference (3 places).
 - ★Continue greasing until old grease is extruded.
 - ★Be sure to use bearing grease.
2. After greasing, wipe off extruded old grease.

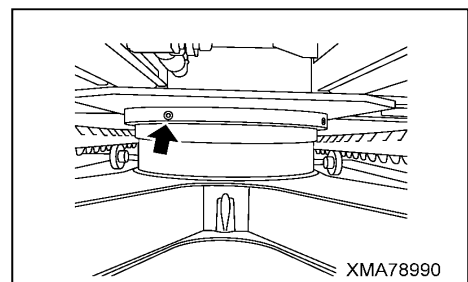

7.10 EVERY 1000 HOURS SERVICE

Carry out “every-50 hours, every-100 hours, every-250 hours and every-500 hours service” at the same time.

[1] CHANGE OIL AND GREASE INSIDE SWING MOTOR REDUCTION GEAR CASE

! WARNING

- After raising the dump body, be sure to set the safety bar to prevent the dump body from lowering.
- Wait for the oil temperature to go down.
- After adding oil and grease, insert the dipstick fully and Close the filler cap and plugs securely, and then wipe up any spilled oil and grease.

★Set a container under the drain port of the swing motor reduction gear case to catch the oil.

★Prepare a grease pump.

1. Raise the dump body.
2. Remove the 8 bolts (2) at the front and rear side of the chassis rear side cover (1) and remove the chassis rear side cover (1).

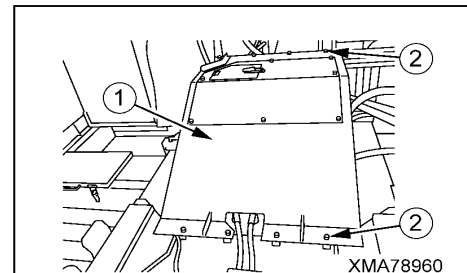

3. Remove the filler cap (4).
4. Turn drain plug (5) of the swing motor reduction gear case to the left (Counter clockwise) and drain the oil inside the swing motor reduction gear case.

★Set the container to catch the oil.

5. After completely draining the oil, tighten drain plug (5).

★Drain plug tightening torque: 60 Nm

6. Fill with gear oil through the oil filler.

★Gear oil refill amount: 1.8 liters (0.48 US gal, 1.54 UK gal)

★Be sure to pull out oil level gauge (3) before refilling with oil.

★After adding gear oil, close the filler cap (4) securely.

7. Check the oil level inside swing motor reduction gear case. For details, see “MAINTENANCE 7.9 EVERY 500 HOURS SERVICE (10)”.

8. Grease the grease nipple (6) of the swing motor reduction gear case.

★Continue greasing until old grease is pushed out of air bleeding port (7) on the opposite side of the swing motor reduction gear case.

★Grease greasing amount: 0.5 liters

★Be sure to use bearing grease.

9. After greasing, wipe off extruded old grease.

10. Set the chassis rear side cover (1) to the original position and tighten the bolts (2).

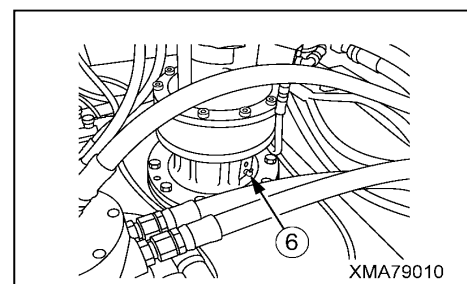
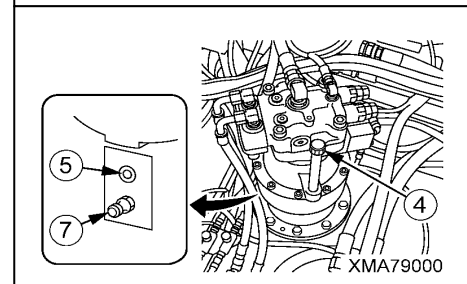

[2] CHECK ALTERNATOR

- ★ The brush may be worn or bearings may lack grease.
Contact your distributor.

[3] CHECK FAN BELT TENSIONER

- ★ It is required to check installed conditions, operating conditions, and damage of the belt tensioner.
Contact your distributor.

[4] CHECK WATER PUMP

- ★ It is required to check installed conditions, operating conditions, and damage of the water separator.
Contact your distributor.

7.11 EVERY 1500 HOURS SERVICE

Carry out “every-50 hours, every-100 hours, every-250 hours, every-500 hours and every-1000 hours service” at the same time.

[1] CHANGE OIL INSIDE TRAVEL MOTOR REDUCTION GEAR CASE

⚠ WARNING

- Stop the engine and wait for the oil temperature to go down.
- After adding oil, tighten the plugs securely and wipe up any spilled oil.

- ★ Set a container under the travel motor reduction gear case to catch the oil.

1. Drive the machine forward or backward to position drain plug (1) of the reduction gear case at the bottom, and then stop the engine.
2. Remove the oil filler plug (3), oil level inspection plug (2), and drain plug (1), and drain the oil inside the case.

- ★ Set the container under the travel motor to catch the oil.

3. Inspect the drained oil.

- ★ If there are large amounts of metal particles or dirt in the drained oil, please contact your distributor.

4. After the oil has been completely drained, tighten the drain plug (1).
5. Add the specified amount of gear oil through the oil filler plug (3), and check that oil comes out from the oil level inspection plug (2) hole.

- ★ For details of the gear oil, see “3. USE OF FUEL AND LUBRICANTS ACCORDING TO AMBIENT TEMPERATURE”.

- ★ Specified amount of gear oil: 7 liters (1.85 US gal, 1.54 UK gal)

6. Tighten the oil filler plug (3) and the oil level inspection plug (2).

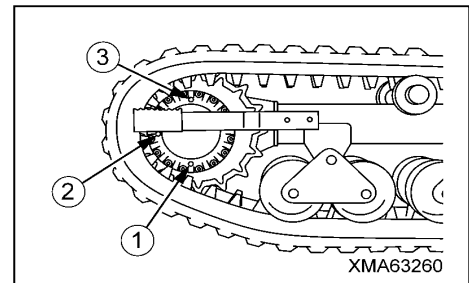

[3] REPLACE ENGINE CRANKCASE BREATHER ELEMENT

⚠ WARNING

- After raising the dump body, be sure to set the safety bar to prevent the dump body from lowering.
- Stop the engine and wait for the temperature to go down.
- When replacing elements, if oil leaks or spills over, be sure to wipe it off completely.

★Set a container under the breather assembly to catch the oil.

★The breather assembly is installed at the left of the engine.

1. Raise the dump body.

2. Open the chassis center inspection cover.

3. Remove the hose (2) under the cap (3) of the breather.

★Cover over removed hose (2) to prevent entry of dirt, etc.

4. Turn the cap (3) under the body (1) of the breather to left (Counter clockwise) and remove the cap (3) and the element.

★Before removing cap (3), confirm match-marks (X) and (Y) on the breather body (1) and cap (3).

5. Remove the element (4) and the seal (5) from the cap (3).

6. Fit the new seal (5) to the new element (4), and it install to the cap (3).

7. Slightly rotate element (4) to both sides to align position (B) with position (A) of body (1).

8. Turn the cap (3) and element to the right (Clockwise) and it install to the body (1) of the breather.

★Finger tighten cap (3) to install it.

After tightening, check that match-marks (X) and (Y) on the breather body (1) and cap (3) are precisely aligned with each other.

9. Connect the hose (3) under the cap (3) of the breather.

10. Close the chassis center inspection cover.

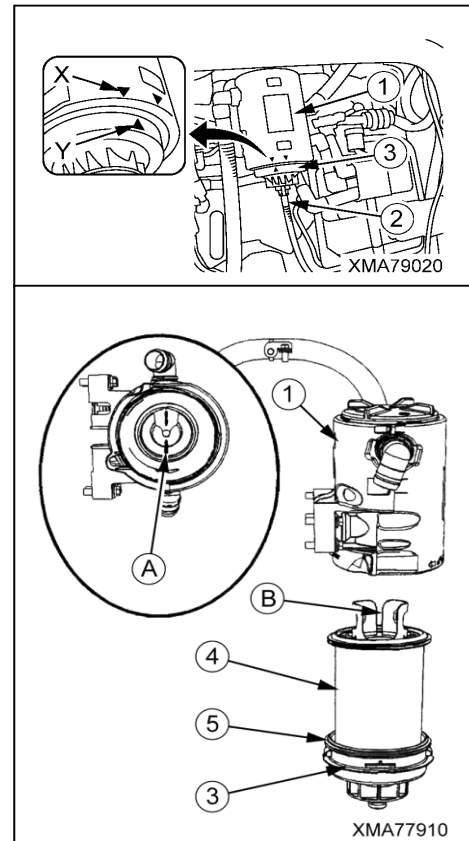

7.12 EVERY 2000 HOURS SERVICE

Carry out “every-50 hours, every-100 hours, every-250 hours, every-500 hours and every-1000 hours service” at the same time.

[1] CHECK ENGINE TURBOCHARGER ROTATING CONDITION

★ Since special tools are necessary for check, contact your distributor.

[2] CHECK STARTING MOTOR

★ The brush may be worn or bearings may lack grease.

Contact your distributor.



SPECIFICATIONS

1. Dimension drawing	4-2
2. Specifications table	4-3

1. DIMENSION DRAWING

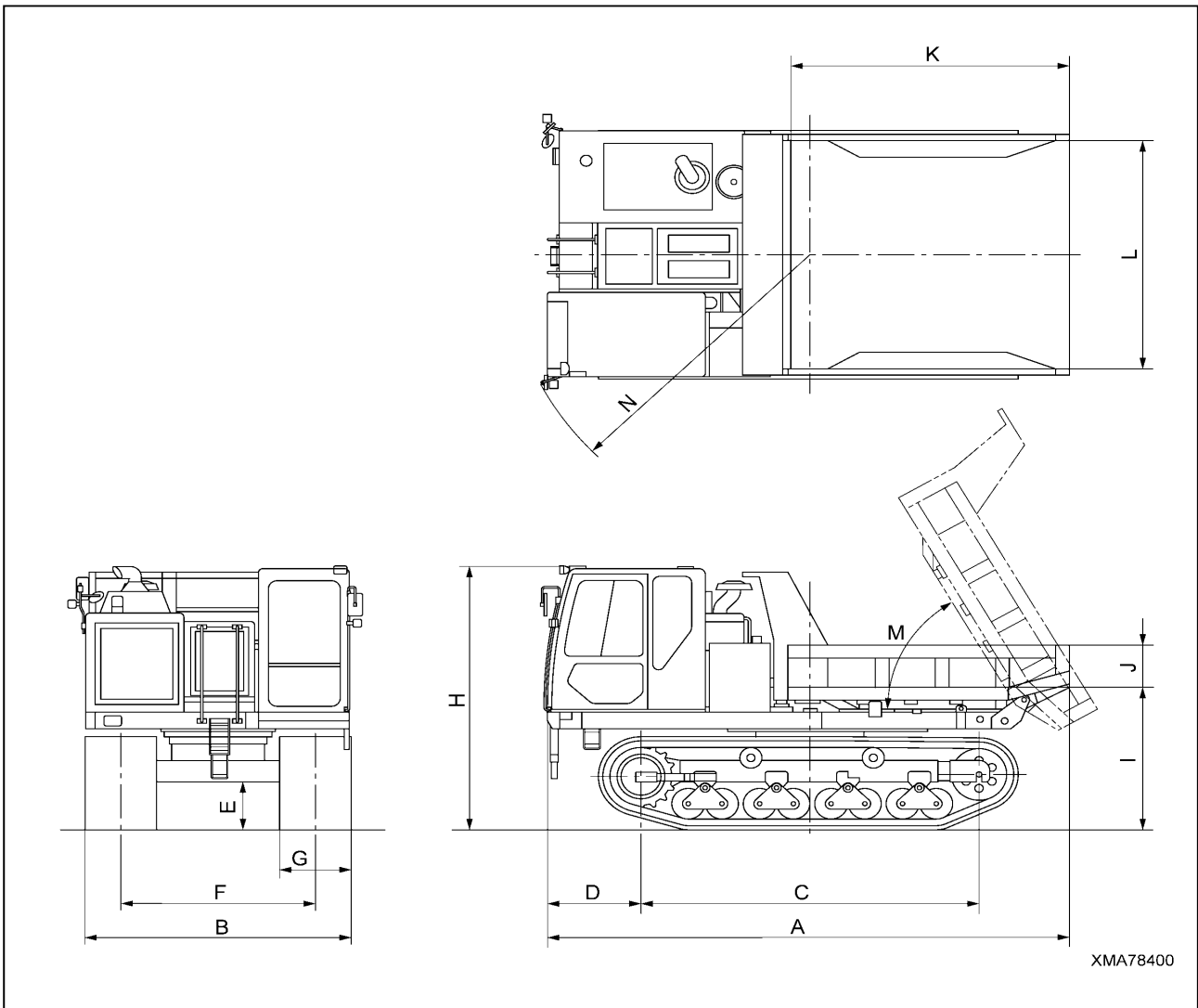



2. SPECIFICATIONS TABLE

Model name			MST-2200VDR
A	Overall length	(mm)	5,900
B	Overall width	(mm)	2,980
C	Distance between center of idler and center of sprocket	(mm)	3,840
D	Distance between front of machine and center of sprocket	(mm)	1,100
E	Min. ground clearance	(mm)	580
F	Track gauge	(mm)	2,180
G	Track width	(mm)	800
H	Overall height (cab roof top)	(mm)	3,200
I	Clearance between ground and bottom of upper revolving structure	(mm)	1,200
J	Dump body height	(mm)	500
K	Dump body length	(mm)	3,200
L	Dump body width	(mm)	2,750
M	Max. dumping angle	(deg)	60
N	Turning radius of upper revolving structure	(mm)	3,380
Mass (weight) of machine operating		(kg)	16,000
Max. payload		(kg)	11,000
Drive system			Fully hydraulic system (HST)
Speed change system			Step-less speed change
Travel speed (at high speed range)		(km/h)	0 – 10km/h
Travel speed (at low speed range)		(km/h)	0 – 8km/h
Ground contact pressure (unloaded)		(kPa)	35.4
Ground contact pressure (loaded)		(kPa)	59.8
Rotating speed		min ⁻¹	4
Hydraulic oil tank rated capacity		(liter)	118
Engine model			Caterpillar C7.1
Engine type			Water-cooled, 4-cycle, in-line upright electronic control type fuel direct injector with turbocharger, air cooled after cooler
No. of cylinders – bore x stroke		(mm)	6 – 105 x 135
Piston displacement		(liter)	7,01
Rated output/engine speed		(kW/min ⁻¹)	186.5/2,000
Fuel			Diesel oil
Fuel tank capacity		(liter)	300
Battery			12V, 140Ah x 2



FULL ROTATION TYPE
RUBBER CRAWLER CARRIER
MST-2200VDR
OPERATION AND MAINTENANCE MANUAL

Document No.AE12200VDR3.5-01

First edition: April 10, 2015

Issued by Morooka Co., Ltd.
358 Shoubeisindenmachi, Ryugasaki,
Ibaraki 301-0031,
Japan